

friGate

сайт из списка my

прогу включен всегда



TRABUCCO

FORM & PERFORMANCE

2015

GENERAL CATALOG

CONFIDENCE, PASSION AND OPTIMISM AROUND TRABUCCO BRAND

Trabucco is a renown brand in the fishing tackle industry for over 30 years, both for match fishing and for amateur fishing. A so long and strong success, always raising since the beginning, comes from the constant wish to face new fishing techniques and from the continuous research of the best materials to build the products that then will be marketed. Thanks to this spirit of innovation and research the company extended its interests, from top level match fishing in fresh water to the most challenging salt water techniques. Every effort the Trabucco company did in these long years had always two goals: to always offer the best products in the market, equipped with most innovative solutions, and marketing it to the best price possible. Because if Trabucco has become one of the leader brands in Italy and in Europe, the merit goes to its customers, that always trusted whom, like them, has only one big passion in mind: fishing.

TRABUCCO PRO TEAM FRESHWATER



ROBERTO TRABUCCO



GIANLUIGI SORTI



GORAN RADOVIC



ALESSANDRO BRUNI



STEFANO BOSI



MAURIZIO FEDELI



MARIO BAPTISTA



MAURIZIO BIOLCATI



ANDREA CARUSO

ROBERTO TRABUCCO 6x National Team World Champion, 1x Individual World Champion for Club, 3x Club World Champion, 2x Italian Individual Champion, 1x European Champion, 8x Italian Team Champion.

GIANLUIGI SORTI 8x World Champion and European Champion, 4x Individual Italian championship winner.

GORAN RADOVIC 2014 Coarse Fishing Individual World Champion.

ALESSANDRO BRUNI Member of the Club Azzurro.

STEFANO BOSI Member of the Club Azzurro.

MAURIZIO FEDELI Member of the Club Azzurro.

MARIO BAPTISTA World and European Champion.

MAURIZIO BIOLCATI Barbel and feeder fishing testimonial.

ANDREA CARUSO Feeder fishing testimonial. Feeder fishing World individual bronze.



GORAN GICA RADOVIC 2014 INDIVIDUAL WORLD CHAMPION

Fish after fish, he draws the interest of a growing attendance, which crowds in behind him. Goran seems to be extremely cool, as he had already fished the same match so many times, as the emotion was a totally unknown sensation to him. The easiness is the trade mark of all great champions; his tackle is Trabucco, not only because he is our long-term testimonial, but because the World Championship can only be fished with trusted material. So Goran confirms that, when a journalist asks him to reveal the used rigs: even hooks, which nobody could ever had the chance to see, are our XPS. He gets the well deserved gold medal, we bring home the immense satisfaction to see enthusiasm growing around Trabucco brand for a result which rewards the efforts of many people and amplifies the optimism for the future.



SURFCASTING PRO TEAM



EMILIANO TENERELLI



GIUSEPPE ALESI



SALVATORE BONACCORSO



WALTER SARRET

EMILIANO TENERELLI Surf and Beach Casting consultant.

GIUSEPPE ALESI Surfcasting testimonial and member of the Club Azzurro.

SALVATORE BONACCORSO Surfcasting testimonial and member of the Club Azzurro.

WALTER SARRET Surf and Beach Casting consultant France.

BOAT FISHING



SAVERIO ROSA



MARIO BARROS

SAVERIO ROSA Saltwater and vertical techniques expert.

MARIO BARROS Sea fishing and vertical jigging consultant.



WARNING! Beside some items in this catalog you will find a QR Code. The QR Code (Quick Read) is a two-dimensional barcode that will allow you immediate access to our website to get a lot of extra information. Download for free the needed software with your Smartphone or Tablet (you can find it in the App Store or you can download it from www.mobilebarcodes.com), scan the QR Code and in real time you can get all the news about the selected product.

PHOTO

Armando Piccinini, Angelo Borgatti, Saverio Rosa, Fabrizio Malavasi, Luca Caslini (www.matchfishing.it), Mario Barros, Giuseppe Alesi, Armando Tiberi, Paolo Chioveili, Maurizio Biolcati, Pankotay Gellért, Mario Baptista, Moroiu Gheorghe, Goran Radovic, Stefano Falciani, Lorenzo Peri, Team Ravanelli, Umberto Tarterini, Roberto Cantaluppi, Mondo Pesca, Alberto Belfiori, Walter Sarret, Balázs Németh, Ivan Lazovic, Srecko Stojanovic, Archivio Trabucco.

RODS	
Long Poles	2
Telescopic Whips	14
Bolo rods	22
Telematch	36
Match Rods	40
Feeder	50
Lake Trout	64
River Trout	72
Specimen & Carp Fishing	76
Surfcasting 2 and 3 Sections	82
Surfcasting Telescopic	100
Light Surf & Beach Legering	108
Teleboat Rods	116
Boat Rods	128
Trolling	134
Hobby	142

REELS	
Reel's Technology	144
Front Drag	148
Micro Front Drag	165
Feeder Fishing	166
Rear Drag	168
Carp Runner	170
Surfcasting & Big Pit	172
Saltwater Power Game	182
Trolling & Jigging	190

MONOFILAMENTS & BRAIDED	
Braided Lines	194
T-Force XPS	196
Original T-Force	200
Saltwater	204
Saltwater & Big Game	206
Surfcasting	208
S-Force	210
Super Elite & Diamond	212
Max Plus & XP-Line	214

HOOKS & PRE TIED RIGS	
XPS Supercarbon Hooks	218
Pro Sword Hooks	223
Lucifer Hooks	224
Pro Sword To Nylon	225
Shinken Hooks	226
Shinken Trebble Hooks	231
Hisashi Hooks	232
Akura Hooks	235
Akura To Nylon	242
Sea Rigs	243
Sabiki	244

FLOATS	
Floats	246
Wagglers & Allrounder Floats	258

GROUNDBAIT & ACCESSORIES	
Groundbait & additives	262
Groundbaiting Accessories	266

LANDING NET & KEEPNETS	
Landing net handles	270
Net Heads & Landing nets	272
Keepnets	274

SEATBOXES & ACCESSORIES	
Seatboxes	276
Accessories and modules	283
Rollers & Rod Rests	292
Umbrellas & banksticks	295

ACCESSORIES	
Match accessories	296
Match Shot & Sinkers	302
Feeders & Accessories	304
Luggage	310
Luggage & Surf Accessories	316
Sea Rig Tackle	320
Swivels	322
Lures	328
Clothing	334
Trabucco On-Line	337

LONG POLES

Every year, the date with new match season brings a lot of work at Trabucco team, with thousands of ideas coming on the drawing board and so much excitement about expected performances. On production side, Reglass grants full quality with advanced materials and his own technology to convert them into fantastic poles, while all practical solution and package building come from the

daily use and from the endless research of Trabucco company.

There is a huge distance between the most sophisticated carbon blank and a real pole to fish with, and the gap can be filled only through technical knowledge, direct experiences and a lot of brainpower to convert such assets into something to crave.



NEW 955 MATCH 1 ONE GNT

TRABUCCO

955 MATCH 1 ONE GNT

The new top of the range GNT 955 is the melting point between the highest technology and the strong wish to amaze the most demanding user with thousands of options.

The new top of the range GNT 955 is the melting point between the highest technology and the strong wish to amaze the most demanding user with thousands of options. In fact, the chances to adapt the pole to personal needs aren't limited to the initial step, but go further, up to each single match, because the match angler doesn't just have one need, but as many as the matches in which he takes part. In other words, the pole is prepared to change according to the venue, to the match strategy and to the personal approach to fishing. A really multiform pole, a real dream now available to everybody. Compared to former 915, sharpness and handling have been improved, thanks to two parallel butts which keep the handle slimmer. Therefore, the section n. 9 (13 m butt) also fits into section nr. 7 to fish at one section less with a stronger butt. Sticking to Trabucco mentality, also this new model is far away from those "silver fish poles" in term of reliability, as there is nothing worst than fishing a match fearing that a sudden breakage could stop it. All this could have been enough to talk about "state-of-the-art safety", but, at such level, safety is never enough! So the pole holds a wild card, to be played when conditions require it: a special kit, made of two super strong sections

(Safety Section Kit), destined to replace sections n. 6 and 7 to raise the whole rod's strength because the area above butt normally bears most of the stress. Further options to face tough conditions can be obtained by Match and Strong combinations of Multi-Tip System, offering reliable blanks and 2,7 or 4,7 mm top bore. Four Match kits are supplied with the pole: two made of four sections

and two of five, all fitting the traditional top section (Ø 1,9 mm), exactly same as the one included in the pole. Two mini extensions fitting sections nr. 6-7-8-9 plus cupping kit, made of three sections with a long top to get same length of a four section's match kit. The pole gets 4 and 5 section's kits belonging to former GNT models.

Code	Description	Length	Ø	C. Length	Weight	Sections
139-46-100	GNT 955 Match One Full Package	13.00	-	-	-	-
139-46-110	GNT 955 Match One 13.00 m	13.00	44	188	920	9

Code	GNT 955 Accessories	Sect.	Length
139-46-010	GNT 955 * Top Kit 5 Match	5	6.20
139-46-020	GNT 955 * Top Kit 4 Match	4	4.40
139-46-050	GNT X55 * Top 2 Multi-Tip Match 40	2	2.95
139-46-055	GNT X55 * Top 2 Multi-Tip Strong 53	2	2.95
139-46-060	GNT X55 * Multi-Section 4	1	1.45
139-46-070	GNT X55 * Safety Section 6&7	2	-
139-46-080	GNT X55 * Mini Extension 13	1	-
139-46-085	GNT X55 * Mini Extension 6/7/8	1	-
139-46-090	GNT X55 * Competition Cupping Kit	3	4.40
139-42-214	GNT Puller Kit	2	3.30

POLE PACK

- 1x GNT 955 Match One
- 2x 5 Sections Match Kit
- 2x 4 Sections Match Kit
- Safety Sections 6 & 7
- 1x Cupping Kit 3 Sect. (4.40 m)
- Short Extension for Butt
- Short Extension for Sections 6-7-8
- Protective Tubes & Gnt Rod Holdall

RED/ASS CARATTERISTICHE TECNICHE:



The Anti-Friction System is a particular process that during the production "prints" on the section a microscopic rough mat layer. This layer offers several improvements to the pole, such as easier shipping and unshipping, lighter section and improves the long-lasting.



Nanolith is a special resin with a nanometric particles, who can easily insert themselves into carbon filaments and epoxy resin assuring this way an improvement of the mechanical characteristics. This to obtain an even more prompt action which results more stable and lighter pole.



Fusion is two high modulus carbons fused together as one whilst wrapped on the mandrel. The end result being ultra rigid top kits with no tip bounce, allowing the angler to hit lightning fast bites with ease.



The Teflon Joints consists in a Teflon coating resin applied onto the male joint. This coating prevent a longer lasting on the section and a perfect precision of the fittings. It also avoid the joints to get stuck when wet or dirty. This concept is applied both on the original sections of the poles and the spare kits.



PARALLEL SECTIONS CONCEPT

MULTI-TIP SYSTEM

MINI EXTENSION

SF SECTIONS



GT TRABUCCO EXTRA PERFORMANCE SERIES

13m Long Pole with 2 Parallel Butt Sections



Safety Sections to Replace Sections 6 & 7



2 x 5 Sections Match Top Kit



2 x 4 Sections Match Top Kit



3 sections Competition Cup Kit (total length 4.40m equal to a match top 4)



Reversible Short Extension fitting into 6°, 7° and 8°



Short Extension fitting into butt section.



Present in the 2 and 1 sections, this new technology is an industry first providing the angler with a silky smooth elastic system. A series of teflon coated inner steps prevents the elastic from making contact with the inner wall of the pole sections, substantially reducing elastic stick, allowing the elastic to gather quickly.



The Clean Caps are made of medium density foam, and have a double utility: every time the male section is fitted, the lips of the Clean Caps clean the inner part of the joint, avoiding dangerous scratches by the sand or dust. In addition to that, once fitted in the male joint, they seal the section avoiding them to sink.



A carbon and resin treatment providing an anti-friction finish that enables the pole to be shipped with incredible ease during wet or dry conditions. This revolutionary surface not only adds strength, but also protects the overall fishing action during hot and cold temperatures

NEW 755 MATCH CARP GNT

Produced in Italy by Reglass, this new pole is perfectly integrated with GNT 955, as it accepts same kits and the exchange of all sections.

Thanks to commercial lakes, now match fishing involves more exciting action than in the past, so the specific pole development is an important segment of Trabucco team's activity. After all, the Serbian ace Goran Radovic won the individual gold at 2014 World Championship fishing with a Trabucco pole of this quality class. His own show, based on barbel in fast running water with rigs in the range of 40-50 grams, will be remembered for the nonchalance of both angler and pole, which stood off the many other breaking under tremendous load. Produced in Italy by Reglass, this new pole is perfectly integrated with GNT 955, as it accepts same kits and the exchange of all sections. Beyond the wall's strength, the only difference between the two models is the long top (with 3,2 mm top bore), which in the 755 replaces the traditional tip and second section, fitting directly on third section. This says why the pole is made of 8 sections instead of 9, also having the two parallel butts as done on the

955. The full package is quite interesting, with three Strong top four kits, whose length of 5,85m is more than enough for most match venues. Cupping kit is included, as well as the two mini extensions to be used not only at full length, but also at shorter

ones. Match and Strong combinations of Multi Tip System can actually widen the already good options offered by this pole, which also accepts 4 and 5 sections kits belonging to former GNT models.

Code	Description	Length	Ø	C. Length	Weight	Sect.
139-47-100	GNT 755 Match Carp Full Package	13.00	-	-	-	-
139-47-110	GNT 755 Match Carp 13.00m	13.00	44	188	1100	8

Code	GNT 755 Accessories	Sect.	Length
139-46-030	GNT 755 * Top Kit 4 Strong	5.85	4
139-46-040	GNT 755 * Top Kit 3 Strong	4.25	3
139-46-050	GNT X55 * Top 2 Multi-Tip Match 40	2.95	2
139-46-055	GNT X55 * Top 2 Multi-Tip Strong 53	2.95	2
139-46-060	GNT X55 * Multi-Section 4	1.45	1
139-46-070	GNT X55 * Safety Section 6&7	-	2
139-46-080	GNT X55 * Mini Extension 13	-	1
139-46-085	GNT X55 * Mini Extension 5/6/7	-	1
139-46-090	GNT X55 * Competition Cupping Kit	4.40	3
139-42-214	GNT Puller Kit	3.30	2

POLE PACK

- 1X GNT 755 Match Carp
- 3X 4 Sections Strong Kit
- 1X 3 Sections Cupping Kit (4.40 m)
- Short Extension for Butt
- Short Extension for Sections 6-7-8
- Protective Tubes
- Gnt Rod Holdall

TRABUCCO

755 MATCH CARP G

Goran Radovic



MULTI-TIP SYSTEM:

Available separately, these kits can be built up adding a strong section nr. 4 (Multi Section 4) to one of following A-B tips:

TOP 2 MULTI-TIP MATCH 40 (Ref. 139-46-050)
Ø 1,8-2,3 mm solid elastic or double elastic

TOP 2 MULTI-TIP STRONG 53 (Ref. 139-46-055)
Large solid or hollow elastics (Ø 2,5 mm and more)

Section nr. 2 of Multi-tip kits are well reinforced to enable the user to drill a hole destined to extract the elastic during big fish fight ("strippa" concept), thus speeding up the operation.

MULTI-TIP MATCH 40

MULTI-TIP STRONG 53

Nr.4

MULTI SECTION 4 (Ref. 139-46-080)

PARALLEL SECTIONS CONCEPT

MULTI-TIP SYSTEM

MINI EXTENSION

REGLASS

MADE IN ITALY

13m Long Pole with 2 Parallel Butt Sections



3 x 4 Sections StrongTop Kit



3 sections Competition Cup Kit (total length 4.40m equal to a match top 4)



Reversible Short Extension fitting into 6°, 7° and 8°



Short Extension fitting into butt section.



GNT PULLER KIT & XPS JOINT CLEANER

THE GNT PULLER KIT is a two sections kit, performing like a traditional match kit but provided with a reinforced part in woven carbon at the base of the second section, in which there can be pierced an hole and insert a PTFE bush. This solution allows the angler to adjust the tension of the elastic while playing a bonus fish, remaining in full control, even employing small diameter elastic. It will be, in fact, sufficient to pull the elastic through the hole to increase the tension and consequently the pressure applied to the fish. In case of a run it will be sufficient to gently release the elastic. Furthermore it will be no longer necessary to bring the fish to the landing net using a kit of 5 or 6 sections, thereby considerably reducing the fighting time and the possibility of accidental breakage of your pole.



XPS JOINT CLEANER is the best solution to maintain your pole's joint in excellent condition, keeping them clean, reducing carbon wear and preventing accidental damages. Xps Joint Cleaner also avoid water entering, while preserving the action of the pole in all conditions.



Code	Model
106-16-010	4th Section
106-16-020	5th Section
106-16-030	6th Section



Stefano Bost

NEW **GNT 845 XTR MATCH**

With this new pole, many goals have been hit at the same time: technical and economical inputs got together to form a tough target, but, at the end of the development process, all those who field tested it agreed that the job has been greatly done.

Trabucco team was looking for a tailor made solution for the club match angler, wishing to buy a quality pole without spending a fortune. Employing high modulus carbon and advanced nano resins, the result can shock also the most demanding user: the pole really deserves the "allround" nickname, offering the right sensitivity to fish ultralight rigs, but also the strength to handle size 10 elastics without top section. His balance is actually surprising, meaning no

stress and easy use for the user. All details have been cared very much, as proved by joints reinforced by woven carbon, a material which provides abrasion resistance and durability. The Trabucco A.S.E.F. slide finish helps the rods running smoothly between hands. All sections are interchangeable with those of GNT 745, and is supplied with a complete package.

Code	Description	Length	Ø	C. Length	Weight	Sect.
139-48-100	GNT 845 XTR Match Full Package	13.00	-	-	-	-
139-48-110	GNT 845 XTR Match 13.00 m	13.00	46	175	880	9

Code	GNT 845 Accessories	Sections	Length
139-48-010	GNT XTR X45 * Top Kit 5 Match	5	6.20
139-48-020	GNT XTR X45 * Top Kit 4 Match	4	4.60
139-48-050	GNT XTR X45 * Competition PW Kit	2	3.20
139-48-060	GNT XTR X45 * Mini Extension	1	-
139-48-070	GNT XTR X45 * Cupping Kit	3	4.50

POLE PACK

- 1x GNT 845 XTR Match 13.00 m
- 2x Kit Match 5 Sections
- 2x Kit Match 4 Sections
- 1X Cupping kit 3 Sections (same length of 4 section kit)
- Mini extension for section nr. 8 and 13 m butt
- Pvc protective tubes
- Trabucco GNT rod holdall

TRABUCCO

845 XTR MATCH

TRABUCCO

745 XTR CARP

GNT X 925 STATION

NEW

- Innovative tubular aluminium frame
- Six Ø 25 mm legs (four telescopic)
- Wide, tilting mud feet
- Sliding aluminium footplate
- Non-marking screws
- Padded pole gel seat
- Padded and adjustable shoulder strap
- Removable base unit, made of:
 - upper tray 4 cm deep
 - central unit with 2 front drawers
 - lower tray 4 cm deep
- Accessories' tray below seat, 4 cm deep
- Compatible with all Genius components and accessories



MODULAR SYSTEM

Find out more on page 277

NEW GNT 745 XTR CARP

It's the "bad sister" of GNT845, structured to bear any sort of load and stress, but, at the same time, balanced and easy to use thanks to the employment of high modulus carbon and nano resins which evenly disperse between carbon layers, even if used in a very limited amount.

The resulting action is quite sharp, with excellent shock absorbing capacity due to the cooperation between carbon sheets. In front of such power, carp, barbel, clarius and mullet rapidly understand that it's not the case to waste any energy during the fight. Elastic rating starts from size 10 to go up hollow models and double ones, practically the whole world of strength. As well as the 845, also this pole fits the traditional top section (60 cm long), linked by

telescopic joint to second section; in case it is removed, any big elastic works even better through 4 mm top bore of the second section, also because it's obviously stiffer than the standard top. All sections are interchangeable with those of GNT 845, are slide finished for a smooth use and display woven carbon reinforced joints to last forever.

Code	Description	Length	Ø	C. Length	Weight	Sect.
139-48-200	GNT 745 XTR Carp Full Package	13.00	-	-	-	-
139-48-210	GNT 745 XTR Carp 13.00 m	13.00	46	175	990	9

Code	GNT 745 Accessories	Sections	Length
139-48-030	GNT XTR X45 * Top Kit 5 Carp	5	6.20
139-48-040	GNT XTR X45 * Top Kit 4 Carp	4	4.60
139-48-050	GNT XTR X45 * Competition PW Kit	2	3.20
139-48-060	GNT XTR X45 * Mini Extension	1	-
139-48-070	GNT XTR X45 * Cupping Kit	2	3.20

POLE PACK

- 1x GNT 745 XTR Carp 13.00 m
- 3x Kit Strong 4 Sections
- 1x Cupping kit 2 Sections
- Mini extension for section nr. 8 and 13 m butt
- Pvc protective tubes
- 6 Tube trabucco gnt rod holdall

GNT TRABUCCO

EXTRA PERFORMANCE SERIES

GNT TRABUCCO

EXTRA PERFORMANCE SERIES

GNT X5 MATCH STATION

NEW



- Tubular aluminium frame
- Six Ø 25 mm legs (four telescopic)
- Wide, tilting mud feet
- Sliding aluminium footplate
- Padded pole gel seat
- Accessorie's tray below seat, 7 cm deep
- Removable base unit, made of:
 - upper tray 4 cm deep
 - central unit with 2 front drawers
 - lower tray 4 cm deep
- Padded and adjustable shoulder strap
- Compatible with all Genius components and accessories

Find out more on page 279

GNT 625 ALLROUNDER



Designed for all types of competition allows match anglers, to use all the features of lightness and balance, and carp lover to exploit the robustness and reliability. As the GNT 625 COMPETITION reaches the actual length of 13.00m with a tip of 35cm and therefore does not require Mini Extension. We would like to specify that the Mini Extension comes in Full Pack for those who want to remove the tip. We suggest, when using elastic in the order of 1.8mm - 2.0mm the angler removes the tip section to further strengthen the pole. GNT 625 is provided in the Full Pack with a complete set of three KIT of 5 sections.

Code	Description	Length	Ø	C. Length	Weight	Sect.
139-44-100	GNT 625 Allrounder Full Package	13.00	-	-	-	-
139-44-110	GNT 625 Allrounder 13.00 m	13.00	45	188	970	9

Code	GNT 625 Accessories	Sections	Length
139-44-002	GNT 625 Allrounder * Top Kit 4 pz	4	4.65
139-44-003	GNT 625 Allrounder * Top Kit 5 pz	5	6.25
139-44-004	GNT 625 Allrounder * Mini Extension	1	-
139-44-005	GNT 625 Allrounder * Cup Kit 2 Section	2	2.95

POLE PACK

- 1x GNT 625 Allrounder 13.00 m
- 3x Kit Competition 5 Sections
- 1x Competition Cupping Kit 2 pz
- 1x Mini Extension
- 2x Pole Pots
- Pvc protective tubes
- 6 Tube trabucco gnt rod holdall



**XPS POWER CORE
HOLLOW LATEX ELASTIC**

**XPS DOUBLE
FLUORO LATEX**

DEMON CARP GNT485

Demon Carp has been equipped with all the features, quality and technology that are needed to compete in venues such as carpdromo or extreme rivers where the equipment is subjected to very strong stress fighting with big and strong fish.

In these cases you need tough and reliable materials which does not suffer wear as those used to build the Gnt 485 Demon Carp. In fact, the high modulus carbon is coated with NTF, which makes it harder preventing crushing, really wear-resistant and waterproof. The top kit 4pcs. and 5pcs. are exchangeable with GNT 715 and

915 giving you the chance to have a specific rod for carp and at the same time increase the number of kits available for your GNT top range rods. A product made in Italy by Reglass synonymous with quality and ongoing assistance in time, offered at a very attractive price.

Code	Description	Length	Ø	C. Length	Weight	Sect.
139-41-900	GNT 485 Demon Carp Full Package	13.00	-	-	-	-
139-41-910	GNT 485 Demon Carp 13.00 m	13.00	47	180	-	9

Code	GNT 485 Accessories	Sections	Length
139-41-002	GNT 05 * Top Kit 4 pz Power	4	4.55
139-41-004	GNT 05 * Top Kit 5 pz Power	5	6.20
139-41-010	GNT 05 * Puller Kit	2	3.30
139-41-007	GNT 05 * Mini Extension	1	-
139-41-008	GNT 05 * Cup Kit 2 Section	2	3.30

POLE PACK

- 1x GNT 485 Demon Carp 13.00 m
- 1x Kit Power 4 Sections
- 1x Competition Cupping Kit 2 pz
- 1x Mini Extension
- 2x Pole Pots
- Pvc protective tubes
- 6 Tube trabucco gnt rod holdall

5 TRABUCCO RSEF ADVANCED SLIDE EASY FINISH

TRABUCCO COMPETITION DESIGN 130

XPS CARP HYPER POWER

XPS FLUORO LATEX

XPS PULLA BUNG

DACRON CONNECTORS

XPS COMPETITION PTFE BUSH

COMPETITION X-FINE SILICONE

Find out more on page 296

DREAM TEAM

XPS NT SUPER SLIM



Maurizio Fedeli

Poles with very low slim diameters, light, and with great qualities of reliability and versatility. Made in 9m length with the possibility to increase through an extension to 10.50m. Entirely built in high modulus carbon and high resistance carbon in the correct areas, it results in an excellently balanced pole with notable rigidity despite its great power. It is the perfect pole for commercial fishery use and in all the competitions where need a very manageable and powerful pole is needed.

POLE PACK

- 1x Dream Team XPS NT Super Slim 9.00 m
- 1x Kit 4 Sections
- 1x Mini Extension
- Tubes & Holdall

Code	Description	Length	Ø	C. Length	Weight	Sect.
138-99-100	D.T. XPS NT Super Slim Full Package	9.00	-	170	-	-
138-99-010	D.T. XPS NT Super Slim * 9.50 m	9.00	39	170	598	8

Code	Dream Team XPS NT SL Accessories	Sections	Length
138-99-003	D.T. XPS NT Super Slim * Kit 3 pz	3	3.45
138-99-002	D.T. XPS NT Super Slim * Kit 4 pz	4	4.70
138-99-005	D.T. XPS NT Super Slim * Mini Extension	1	-
138-99-010	D.T. XPS NT Carp Plus TX * Long Extension	1	1.70

TRABUCCO

WORLD CLASS

DREAM TEAM

TRABUCCO

WORLD CLASS

DREAM TEAM

DREAM TEAM XPS

M1 CARP

This pole is offered at 10,00 mt. only, and it is made entirely of Carbon High Module combined with Carbon High Resistance. This particular production process allow to get a very light and well balanced product. It is also very strong and reliable, and can be used both for silver fishing and commercial fisheries. It can be fitted with an elastic rating 20, and if necessary, it can be a very powerful tool able to land big carps. The action is crisp and the tip has been already produced with a large hole in which you can easily fit a hollow elastic of big size without any cut. The pole has 3 graphics sections.

POLE PACK

- 1x Dream Team XPS 10 m
- 1x Power Kit

Code	Description	Length	Ø	C. Length	Weight	Sect.
139-65-010	Dream Team XPS M1 Carp	10.00	43	169	850	7
139-65-100	D.T. XPS M1 CARP Full Package	10.00	-	-	-	-
139-65-001	Power Kit	2.00	-	-	-	2
139-65-002	Top Kit 3 Section	3.00	-	-	-	3



Fabio Negri

TRABUCCO

WORLD CLASS

DREAM TEAM

TRABUCCO

WORLD CLASS

DREAM TEAM

TRABUCCO

DREAM TEAM

DREAM TEAM XPS TX SLIM MATCH

Extremely thin and light pole, from the great dowries of reliability in a different use.

Extremely thin and light pole, from the great dowries of reliability in a different use. Made in the length of 9,50 mt. with the possibility of lengthen through an extension to 11,00 mt. Entirely built in HM and high resistance carbon used in the parts more solicited, it results to excellently be balanced and with a notable rigidity despite the great power of catch. Is' a perfect pole for fishing in commercial fishery and in all the competitions where need a very manageable and powerful pole.

POLE PACK

- 1x Dream Team XPS TX Slim Match 9.50 m
- 1x Extension 11 m
- 2x Kit 4 Sections
- 1x Mini Extension
- Tubes & Holdall

Code	Description	Length	Ø	C. Length	Sect.
139-66-100	D.T. XPS TX Slim Match Full Package	11.00	42	170	7

Code	XPS TX Slim Match Accessories	Sections	Length
139-66-001	D.T. XPS TX Slim Match * Power Kit	2	2.80
139-66-003	D.T. XPS TX Slim Match * Kit 4 Section	4	4.45
139-66-004	D.T. XPS TX Slim Match * Mini Extension	1	-

Stefano Bosi



DREAM TEAM XPS SC SPECIAL CARP

This log pole is realized in carbon HM and HR to be able to get the good compromise among lightness and reliability, essential for the fishing in the carp fishery in which it is had to fight with big fish. The action results to be very stiff, thanks to the big hole can be use with big traditional elastic and with the allow one. Available in the measure of Mt. 10 are equipped of mini extension, and it is purchasable separately the Kit besides to 4 sections.

Code	Description	Length	Ø	C. Length	Weight	Sect.
139-72-010	Dream Team XPS SC	10.00	43	170 mm	840	7+1
139-72-001	Dream Team XPS SC Kit 4	-	-	147 mm	124	4
139-65-001	Power Kit	2.00	-	-	-	2
139-65-002	Top Kit 3 Section	3.00	-	-	-	3

DREAM TEAM XTR MARGIN

Specially developed for commercial close-in fishing, which of course meets his peak during summer months when carp patrol the bank to look for food. The High Resistance carbon blank can face the toughest battle, even though the chance to drive the elastic through the dedicated door (XTR Strippa on section nr. 2) reduces the stress on the pole because most of the fight is run with rod tip in line with the rig. Nothing to do with those standard commercial "speedy" poles, which aren't speedy at all because the pressure on fish is so high to cause panic, with longer fight time and growing chances to miss a few fish. Easy to clean, the rod's surface has been slide finished (Trabucco A.S.E.F.) to smoothly run forth and back by hundreds of times. The XTR Margin Pro

has all sections put-over, including top with 4 mm bore, and is supplied with an extra 2 section's kit (2,65 m), exactly same as the top two sections of the pole. Further kits can be bought separately.

Code	Description	Length	Ø	C. Length	Weight	Sect.
131-86-600	D.T. XTR Margin Pro * 6004	5.60	32	160	430 g	4
131-86-610	D.T. XTR Margin Pro * Sp.Kit	2.65	-	140	-	2





LRC CX2
LOW RESIN
CONTENT CARBON
NANO-TEK

It's the most sophisticated material employed in the production of Trabucco rods: a super high modulus carbon, whose layers are carefully assembled with exclusive nano-technological resins to obtain extremely light, compact, resistant sheets which are able to provide a sharp reaction in front of any sort of strain. Its proven strength enables our engineers to even use it in the most advanced surf casting rods.

CX2
CARBON
NANO-TEK

High modulus carbon material, located very close to the fantastic LRC-CX2 in the list of high grade materials. Since the resin distribution is less dramatic, it's possible to combine it with lower modulus materials, to generate light and strong rods with size by size programmed action to face the most various fishing conditions.

CX0
CARBON
MICRO-PITCH

Before getting through the curing process, the carbon blanks are wound by a special tape, which is free from any elasticity to contrast the expansion of the metallic mandrel. In such way, the resins are well distributed within carbon layers. The narrower the tape's pitch, the lower the resin content, and consequently the rod's blank will be lighter and reactive, thus perfect to create high grade fishing rods.

CX-1
CARBON

The super sharp actioned rods aren't needed in all fishing styles: for example, bolognese or telescopic poles differ from carp fishing or boat rods, where reaction times are slower and the stress is heavier and longer. That's why CX1 is so important, with its special balance between strength and lightness which, compared to Micro Pitch version, gives the rod a lower reactivity both during cast and strike.

**S.H.M.R.
CARBON**

It is the most widely used material for medium range rods, because it's perfect to solve at the same time all problems linked to costs and performances. The final products are nice to handle and quite durable, even if called to face hard life on the water.

HRC
HIGH RESISTANCE COMPOSITE

The high end technology is not purely concentrated on top of the range products, but also gives the best in case of intermediate ones, where price counts. Made from a blend of carbon and fiberglass, it finds place in all branches of sport fishing.

**POWER
FIBRE**

A special fiberglass material, able to develop outstanding strength in front of extreme stress, but also to bear the inevitable abuse due to inexperienced handling. This is the perfect material for rods destined to occasional or novice anglers.

HVE
HIGH VOLUME EPOXY-FIBER

Based on fiberglass, this material shows layers linked by an advanced system of epoxy resins. As a consequence, its structure is extremely compact, and generate tubular blanks which are particularly strong and durable.



The advanced high modulus carbon sheet, which gives enormous power to the rod's blank, sweetly blends into softer materials to provide the right sensitivity to detect fish bites. But the conversion is gradual, within the tubular top section, and this requires high class technology to avoid weak points and curve imperfections, which would cause poor looking but also a bad power transfer, with some risks of sudden breakage for the structure. All over the world, this concept is well known as "multi-action tip", but it's not equally common the process of layer's overlapping and fusion which bring to a perfect result, inch by inch. The technology which leads to the perfection of final product can give the best only in case the engineering and design process are assisted by computer, which can evaluate the stress point by point and realistically simulate the reaction of the material according to the fixed specifications.



The concept behind the Hybrid Tip arises from the need to obtain a good tip action on all models in our surf casting range, in order to compare the performance between the lower and the higher level rods. We then managed to get the unsurpassed sensitivity of a solid carbon tip design matching perfectly with the power of a tubular carbon blank, whatever the modulus of the carbon used to build the rod itself. With this hybrid solution, the blank takes care of the part inherent to the casting action, charging power before releasing it during the lash, while the tip takes care of directionality, of the accuracy and, obviously, of the identification of even the lightest fish bites at very long range. The crucial part is obviously the transition between the tubular carbon blank and the solid tip, subject where we have applied all our famous design capabilities.

In recent times, all over the world the sport of fishing has seen a dramatic specialization, with so many different new techniques which have satisfied the most advanced anglers, but have scared the newcomers. At first, rods have been changing more than the rest of tackle, and so have done the technologies needed to get the best from materials. In such scenario, we must be clear, and that's why we use some logos and icons, which are here explained.



SS SUPER SLIM BLANK

In some segments of sport fishing, the super slim profiled rods are very much appreciated for their natural lightness and for easy handling. In order to give these rods the required level of strength, Trabucco employs the most advanced production's technologies.

ULTRA CONIC BLANK

The taper of the blank provides balance and the right power to cast and drive the fighting fish to the landing net. Some special Trabucco rods show faster taper than the average, in order to develop a certain behaviour while in action.

SUPER PROGRESSIVE JOINT

In all sort of fishing rods, both telescopic and put over, joints are the most critical areas. Our own joints sweetly follow the rod's action, avoiding those "flat spots" which cause bend imperfections and seriously prejudice rod's strength.

X Power Joint

This technology gives strength to the rod's joints, but without exceeding in weight. This is possible because it takes advantage from high modulus carbon used to create crossed reinforcements, which bear the stress peaks in those areas.

CW CROSS WINDING

The rod's blank is carefully wound by a carbon yarn braiding, which contrasts the ovalization under stress. As a consequence, the tubular is far stronger and, at the same time, the whole rod is definitely sharper. Both results are achieved without any sensible weight increase.

CROSSED REINFORCED

When a rod is designed to face extreme stress and maybe some shocks, its joints need to be adequately protected to last long time. We solve this problem with High Resistance carbon bands, applied orthogonally to longitudinal fibers

high precision control

Within any telescopic rods, the joint's precision is quite important to grant absence of play, not only to avoid noise, but mainly for a complete power transfer. For this reason, Trabucco rods are produced under the computer assistance.

Zero Friction Blank

A special finish of blank's surface repels water droplets which inevitably wet the rod, both during rainy or sunny days. This prevents line from sticking to the blank, an inconvenience which heavily affects casting distances, specially with light rigs.

MULTI LENGTH SYSTEM

In the river trout telescopic rods, as well as in some sea boat rods, the length is adjustable thanks to special rubber collars, which are fixed on top of sections to lock them to the below one. This is a careful job, done with hand craft precision.

2 FLEX TIP 3 FLEX TIP

The great sensitivity and the resistance to traction of the interchangeable fiberglass tips are important assets to influence boat rod's performance. The small single leg guides are well aligned and then carefully wrapped.

TIP

In the segment of sea boat rods, this icon marks the models which aren't supplied with interchangeable tips, but only have a solid fiberglass telescopic tip. No difference regarding sensitivity and durability.

SENSI TOUCH

A fantastic sensation of smoothness and a greater control of the rod comes from the special finish of carbon rod handles. Apart from improving the fishing pleasure, this finish helps rod's cleaning after each fishing session.

TELESCOPIC WHIPS

At the beginning there is always a whip. You start to fish with this rod, then move to Bolognese, then Match rod, then to the long pole and at the end of this journey that lasts for years ... everyone realizes that the fishing which gives greatest satisfaction is without rings, without reel, without elastic ... with only a thin terminal that will make you feel your prey. Trabucco offers a wide range of technologically advanced and specialized products to meet the beginner and expert needs ... and here we are able to offer you the best rods on the market.



Gianluigi Sorti



ASTORE TX POLE



In the design stage we identified the target to be pursued: the best competition pole rod. Every single element, every detail has been studied and revised only in order to get what for us is perfection: the Astore TX Pole. The blank has been built with the purest super high modulus carbon, light, reliable, essential in its dynamic elasticity. The fibers were then distributed on the mandrels according to a radial pattern so that the rod could respond safely to any type of torsion and bending. Butt section is long, a prerequisite for having an absolutely perfect balance. The tip has been built in combination with a solid carbon final part to allow maximum strike speed and to better manage the smallest monofilaments, resulting in a fast tip action and the best possible bending curve. Designed by agonists for agonists, it can not avoid to let every angler open-mouthed.

Code	Length	C. Length	Weight	Sections
134-21-500	5.00	130	160	5
134-21-600	6.00	130	220	6
134-21-700	7.00	130	270	7
134-21-800	8.00	130	365	8
134-21-900	9.00	130	490	9





ENERGHIA 2K EXTREME

SENSI TOUCH
CX2 CARBON NANO-TEK

Brand new series of telepole rods built in CX-2 super high modulus carbon, designed for high level competition. The blank of these rods is incredibly slim (we mean REALLY slim: 22.7 mm for the 8 meters model) and highly performing, while the tip section is tubular and not spliced. The blank is perfectly balanced, and it is possible to fish for hours without any problem. We do believe to have achieved the best production possible with the technology available nowadays.

Code	Length	C. Length	Weight	Sections
134-31-800	8.00	128	275	8
134-31-900	9.00	128	350	9
134-31-990	10.00	128	420	10



Marco De Biase



ASTORE TX ALBORELLA

The Trabucco rods specific for bleak fishing are renowned worldwide, thanks to the high quality of the Super High Modulus Carbon blanks and the perfection of their action. The Astore TX Alborella have been built designing a super conical blank, totally different from any other whip in the world. We choose to design these rods in this peculiar way because we needed to get a super fast reactive and light weight blank. The tip is made of solid carbon to increase speed of action, sensitivity and fish management. Italians are famous super good bleak anglers and Trabucco rods are the best choice for them.

Code	Length
134-12-000	Set 2.50m-3.00m-3.50m-4.00m-4.50m

Code	Length	C. Length	Weight	Sections
134-12-250	2.50	120	57	3
134-12-300	3.00	120	89	4
134-12-350	3.50	120	109	4
134-12-400	4.00	120	135	5
134-12-450	4.50	120	165	5



Astore Alborella can be also purchased in a 5 rods set supplied in a padded handy bag which is easy to carry and protects the rods from shocks.



ASTORE NRG POLE

SENSI TOUCH
CY2
CARBON
NANO-TEK

Three model series, from 7 to 9 meters, very well balanced and stiff. They have been developed to be used in a number of fishing situations, including competition, and are built in S.H.M. carbon to enhance resistance and lightness, never enough when you come fishing with 8 or 9 meters pole. The slim blank allow a superior handling and better fishing experience, both in fresh and salt water.



Code	Length	C. Length	Weight	Sections
134-23-700	7.00	140	320	7
134-23-800	8.00	140	400	8
134-23-900	9.00	140	500	9



ATOMIC

WELL BALANCED AND POWERFUL, THEY GRANT YOU LOADS OF SATISFACTION!

Atomic is the name of a new series of telescopic whips, which feature an extraordinary lifting power and an outstanding reliability.

If you are strong enough, and your line is equally good, you can rely on these rods, and they will reward you with plenty of adrenaline and a lot of fish in your net!





NEW ATOMIC XS POLE

CW CROSS WINDING SENSi TOUCH CX-1 CARBON



It's the natural sister of Atomic bolos: nice but aggressive, very aggressive when it's time to show the muscles. And it's dressed in line with them, with a young cosmetic which should recall that Trabucco's know-how can repro-

duce the same reliability and strength of bolo also in a telescopic pole. As a matter of fact, these Atomic XS poles are suitable for mullet fishing, like declared on the butt section, a mission which is possible only when the best technology is employed, as done here with CX1 carbon and Cross Winding carbon yarn reinforcement. Those who have experienced the rod being pulled from hands, maybe in a fast running river, know that strength is vital in this sort of poles, and that the freedom to use thicker line than usual - being sure that the rod will cooperate - is worth because brings more fish to the landing net.



Code	Length	C. Length	Weight	Sections
134-24-700	7.00	140	320	6
134-24-800	8.00	140	400	7
134-24-900	9.00	140	500	8

ATOMIC STX

SENSi TOUCH CX-1 CARBON

Series of powerful poles suitable for the toughest fish techniques and conditions in which it is impossible to leave too much room for prey fighting. Strong, tough but well balanced and pleasant to use. It can lift up to 2 kg without the slightest problem. The blank is made of Carbon CX-1.



Code	Length	C. Length	Weight	Sections
122-54-960	6.00	120	293	6
122-54-970	7.00	120	385	7



Gianluigi Sorti





TITAN TLS POWER



A very nice pole rod series, extraordinarily balanced and not heavy at all, even considering the fact that they are able to lift preys up to 1.5 Kilos. The CX-1 Carbon blank is reinforced with a spiral of high resistance carbon.

Code	Length	C. Length	Weight	Sections
134-26-500	5.00	128	210	5
134-26-600	6.00	128	298	6
134-26-700	7.00	128	394	7
134-26-800	8.00	128	510	8
134-26-900	9.00	128	595	9



NEW SELEKTOR TLS POWER



Marco De Biase

Among the Trabucco telescopic poles, this is the most powerful one, with the high resistance SHMR carbon providing the power needed to stop the first run of any big fish, plus the crossed carbon bands protecting joints. The long, tubular top section displays a nice action, which is well followed by second section to care for the hooklink when the rod is almost vertical to let landing net come into play. But the Selektor TLS stands also for the short closed length, a good specification for a rod which could be permanently stored in the car's boot, along with a couple of rigs to be ready in case of fish. All inner sections are nicely painted in satin black, just because even the rods destined to tough life should carry a touch of Italian taste.



Code	Length	C. Length	Weight	Sections
134-29-600	6.00	120	280	6
134-29-700	7.00	120	400	7
134-29-800	8.00	120	480	8

NEW ACTIVA STX POLE

CROSS reinforced
SENSI TOUCH
CROSSED reinforced
high precision control
S.H.M.R. CARBON



Goran Radovic

Stiff enough to show powerful fish who is the leader, but also light to be used till sunset without stress. On the river, at lake or seaside, Activa STX is a reliable partner, reactive and enjoyable to extend the fishing pleasure. Everything lives in its blank: built from CX1 high modulus carbon, then wrapped by a carbon yarn reinforcement which contrast its deformations, not only to prevent breakages, but also to improve its sharpness. In fact, such braiding is missing on top and second section, so that those sections are free to display their perfect action curve. The exclusive Sensi Touch handle finish is a really nice feature, practically a signature which identifies many good Trabucco rods.



Code	Length	C. Length	Weight	Sections
134-34-500	5.00	135	215	5
134-34-600	6.00	135	275	6
134-34-700	7.00	135	370	7
134-34-800	8.00	135	485	8
134-34-900	9.00	135	570	9

ACTIVA POLE

SENSI TOUCH
CROSSED reinforced
high precision control
S.H.M.R. CARBON

Series of whips particularly easy to transport because are compact and when closed they are really short. The low diameter blank together with a perfect balance make these rods extremely good and similar to more expensive ones, and they are offered at a nice price.

Code	Length	C. Length	Weight	Sections
134-33-500	5.00	113	209	5
134-33-600	6.00	113	272	6
134-33-700	7.00	113	366	7



XPS HOOKS

NEW

When the hook is fixed at the end of a telescopic pole rig, it's certainly destined to hard life, because it cannot get protection from the elastic – as it happens in case of pole fishing – and doesn't benefit from reel's drag assistance, as normally occur in all the other fishing styles.

The striking power arrives directly and, when line gets to maximum tension, the hook receives 100% of load. That's why the steel quality is so important, because the property to absorb the stress, always recovering the original shape, it's a vital condition to provide efficiency and durability.

All XPS series are particularly brilliant in this sense, due to the high quality of materials used in their production process.



Find out more on page 218

NEW ERION X-LIGHT POLE

SS SUPER SLIM BLANK SENSi TOUCH



The former Erion TLS, built from High Modulus carbon material, now grows and gets specialized in two different versions: X-Light and X-Power, answering from one side the demand of lightness coming by the finest anglers, and from the other side the need of power in front of big river and sea fish. Thanks to the particularly fine handles (Super Slim Blank), this X-Light series is quite handy yet well balanced. Its tubular top is designed to also deal with light floats and fine hooklinks. Sensi Touch handle is obtained from a satin coating which doubles the fishing pleasure.

Code	Length	C. Length	Weight	Sections
134-15-400	4.00	130	110	4
134-15-500	5.00	130	180	5
134-15-600	6.00	130	250	6
134-15-700	7.00	130	315	7



SYNTIUM POLE

SENSi TOUCH CROSSED REINFORCED



This telescopic rods is available in 4.00m to 8.00 m lengths. Constructed entirely in High Modulus carbon with special reinforcement at the base of every section. The S.H.M.R carbon has been used for these rods, giving them great balance, reliability and rigidity, combined with very slim sections to give an extremely manageable and versatile rod. Thanks to these features, these rods can be used for both freshwater and salt water fishing with excellent results. The progressive tip action delivers a superb fish playing action.



Code	Length	C. Length	Weight	Sections
134-16-400	4.00	123	152	4
134-16-500	5.00	123	233	5
134-16-600	6.00	123	317	6
134-16-700	7.00	123	390	7
134-16-800	8.00	123	510	8



NEW ERION X-PWR POLE



It's the bad sister of Erion X-Light, able to drive the most powerful fish to landing net, thanks to its blank's construction, designed with fast tapered profile. The high level of reliability also comes from the High Resistance carbon joint's reinforcements, which has been applied to contrast dangerous deformations thus grant them a longer life. The tubular top section is a must on rods, like this, which are destined to tough life due to big and restless river fish, as well as to the speed of sea fish like mullet and sea bream. The handle grip is coated with a special satin finish (Sensi Touch).

Code	Length	C. Length	Weight	Sections
134-28-500	5.00	130	230	5
134-28-600	6.00	130	340	6
134-28-700	7.00	130	450	7



Maurizio Fedeli

TRABUCCO ENGINEERED

XLIGHT

TRABUCCO ENGINEERED

XPWR

XPS POWER PLUS & XPS MATCH PRO



In spite of the apparent simplicity, the rigs destined to telescopic poles have their own problems. Talking about main line, an high abrasion resistant line is always recommended, as it should survive the compression caused by lead shots and the excess heat due to their movement along the line. No problem for XPS Match Pro,

whose polymer include ceramic components which harden the surface and keep low temperature. The hooklink's worst enemies are knots, both on hook's spade and connection to mainline. Therefore, the right solution is called XPS Power Plus, as its balanced elasticity avoids knot's coils damaging each other.

TRABUCCO ENGINEERED

Find out more on page 197

BOLO RODS

Over 40 years of experience on competitions, 25 of which passed to design and develop the best bolognese in the world. This is the best guarantee that we can give to a product, a guarantee that only a World Champion like Roberto Trabucco can offer to fans of this unique fishing technique, unequivocally Made in Italy! A fishing technique, that changes and evolves over time, where only those who can anticipate new trends, can really provide the innovation and technology necessary to define an "edge" product. What about ... even if they continue to imitate us, we will continue to be a step ahead!





NEW ENERGHIA 2KS COMPETITION

The most glorious range of Trabucco bolognese grows again, thanks to the technological evolution but also thanks to endless progression of the most traditional Italian fishing style. So the Competition is here to shock everybody, with its amazing CX2 carbon material which has proven to be breakage free, thanks to the even dispersion of the nano-technological resin, deputed to seal the carbon layers. This project has taken into consideration the need to more and more use fine lines and small hooks, which require the right sweetness in the rod, without missing the reactivity. The series fits hi-leg SiC guides to avoid wet line sticking to the blank.

Fantastic details are the satin finish of whole butt section and woven carbon reinforcement applied on to reel seat area.

SS SUPER SLIM BLANK SENSi TOUCH CX2 CARBON NANO-TEK

Code	Length	C. Length	Weight	Sections	Guides
120-96-600	6.00	150	215	5	SiC
120-96-700	7.00	150	265	6	SiC
120-96-800	8.00	150	340	7	SiC

NEW ENERGHIA 2KS ALLROUND

Developed along with Competition series, this one took Allround nickname to remark that it can escape from the perfect world of match fishing and spend a day on a fast river or at exciting sea side. Its body is stiffer than Competition's one, and also a big fish can quickly detect the difference, as it turns the head back to the bank where we are waiting with the camera. The sliding guide on second section plays an important role, because it can distribute the load and straighten the line during cast, adding metres to the reachable distance, specially during those rainy days. Also the Allround is fitted with long leg SiC

guides to protect the line, specially when the terrible combination of tension and friction would inevitably push the temperature to a dangerous level.

SS SUPER SLIM BLANK SENSi TOUCH CX2 CARBON NANO-TEK

Code	Length	C. Length	Weight	Sections	Guides
120-97-600	6.00	154	250	6	SiC
120-97-700	7.00	154	330	7	SiC

ENERGHIA 2K EXTREME

The Energhia 2K has been designed for competition and it is dedicated to all those anglers who wants the best performing equipment. This series of high end Bolognese rods are simply the best you can buy; they are so light and balanced! Butt section diameter is as small as only 21 mm in the 7 meters model: it seems science fiction. Ultimate technology and Super High Modulus Carbon CX-2 Nano Tech make this rod the best gift you can ask for yourself.

SS SUPER SLIM BLANK SENSi TOUCH CX2 CARBON NANO-TEK

Code	Length	C. Length	Weight	Sections	Guides
120-95-600	6.00	145	180	6	SiC
120-95-700	7.00	149	220	6	SiC

SPECIFICATIONS:



Ultralight long leg guides with SiC ring, designed to avoid any contact between line and rod's blank.



Woven Carbon reinforcement in the handle area.



Size 6 plate reel seat, made from steel and featuring rubber foot to disperse pressure on the rod's handle.



ENERGHIA TXL



ENERGHIA TXL PRO LIGHT

SENSI TOUCH **CX2** CARBON NANO-TEK

The best super high modulus carbon CX-2, elaborated by distributing its fibers in a radial way, can only result in the most sophisticated compromise between lightness and power. The fibers of nano-carbon CX-2 are omni-directionally arranged, making the entire blank extremely resistant to compression and torsion. The blank is so fast action and extremely well balanced and handy while fighting the fish, seconding prey runs to minimize the risk of hook link breaking. The rod is equipped with long leg frame SiC in order to allow a perfect sliding of the line even in rainy conditions.

Code	Length	C. Length	Weight	Sections	Guides
120-92-600	6.00	136	305	6	SiC
120-92-700	7.00	136	375	7	SiC
120-92-800	8.00	146	460	7	SiC

ENERGHIA TXL ALLROUND

SENSI TOUCH **CX2** CARBON NANO-TEK

An intense design effort in combination with the use of super high modulus radial CX-2 carbon have created a very special rod with unique and inimitable features. A slim blank, lightweight and balanced but at the same time capable of the more amazing performance. The action, distinctly tip action, enables to successfully fight big fish, both in fresh water in large and fast running rivers and at sea, where the power is never enough. The rod is equipped with long leg frame SiC in order to allow a perfect sliding of the line even in rainy conditions; all sliding guides are wrapped on to carbon pipes fitting each other. No chance to find another rod which can stand up to Energhia TXL Allround!

Code	Length	C. Length	Weight	Sections	Guides
120-93-500	5.00	131	185	5	SiC
120-93-600	6.00	131	275	6	SiC
120-93-700	7.00	131	340	7	SiC

SPECIFICATIONS:



Long leg SiC guides.



Woven Carbon reinforcement in the handle area.



Aluminium butt cap with rubber insert.



Gianluigi Sorti



ENERGHIA TXL POWER

SENSI TOUCH **CX2** CARBON NANO-TEK

Who said that strong action rods must necessarily be heavy, imbalanced or have too big butt sections? The TXL Energhia Power is the proof that a careful study of each element as a function of the whole tool and the research of the best materials available can overcome all these compromises that are usually accepted. The blank of this mighty rod is so slim and yet incredibly robust and ready to respond to stress. The super high modulus CX-2 carbon used for its construction was in fact worked in a way that individual fibers are disposed in a radial position, so that they can withstand the strains even the most

extreme, coming from any direction. The feeling of power that a rod like Energhia TXL Power transmit you is just sublime.

Code	Length	C. Length	Weight	Sections	Guides
120-94-600	6.00	152	310	6	SIC
120-94-700	7.00	152	365	7	SIC

T-FORCE XPS SOFT FEEL

The latest generation of high resistance monofilaments issued by the T-Force technology the World's leading producer of hi-tech fishing monofilaments. With its strength exceeding even extreme limits this line also features a total memory absence. XPS Soft Feel is an ultra-supple monofilament specifically developed for all styles of reel fishing. It's a floating line so it's particularly suited to Bolognese both for fresh and saltwater uses. Its smoothness helps line flowing from the reel spool during casts, without any kind of torsion and increasing casting distances.



Find out more on page 198

ATOMIC

EXPERIENCE, POWER,
CONTROL



NEW ATOMIC XS COMPETITION

In Italy, as well as in the rest of Europe, Atomic has become synonymous of tremendous power and strength, thanks to outstanding rod performances, not thanks to advertising! Within the new range, this Competition series is the access door to the Atomic world, a sort of link to the most powerful ones, which are identified by growing numbers like 2, 4

and 6. Its structure is fast tapered, with a compact closed length and a reasonably fine top area, which allow a certain casting precision and tolerate the use of relatively fine hooklinks (not less than 0,14 mm). The medium leg SIC guides have a vibration-free "Y" shape frame, while the plate reel seat is wide enough to accept big size reels (size 7).



ATOMIC STX

Series of very powerful Bolognese rods adapted to the heaviest styles of fishing. CX-1 reinforced carbon blank with SIC guides. These rods are so powerful and strong they

can lift preys up to 2 kilos weight, a very useful specification in fast running rivers and in the seaports, between docked boats.





- X6
- X4
- X2
- XS
- STX

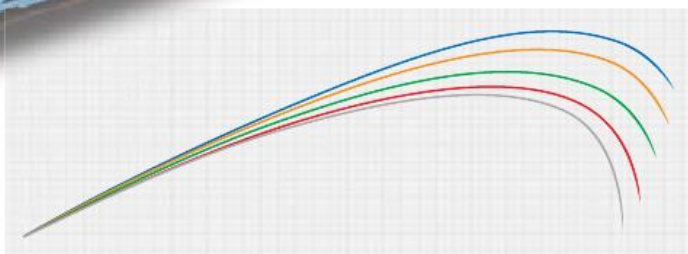

Model	Max Load	Casting
X6 FORMULA	6.0kg	100g
X4 FORMULA	4.0kg	80g
X2 FORMULA	2.0kg +	60g
XS COMPETITION	1.5kg	30g
STX FORMULA	2.0kg	60g

Atomic actions. Each one of these rods is designed to target a certain job. In fact, when loaded by same test weight, the five series react in a different way, confirming that they have been built to develop a specific power range.

SENSI TOUCH **CX-1 CARBON**

Code	Length	C. Length	Weight	Sections	Guides
122-55-500	5.00	130	220	5	SiC
122-55-600	6.00	132	290	6	SiC
122-55-700	7.00	134	375	7	SiC



SENSI TOUCH **CX-1 CARBON**

Code	Length	C. Length	Weight	Sections	Guides
122-54-500	5.00	128	232	5	SiC
122-54-600	6.00	130	318	6	SiC
122-54-700	7.00	132	427	7	SiC



Since ever, Atomic by Trabucco means power for long range casting and strength to successfully drive big fish to the landing net. But such tremendous power is not without control, as each single action has been engineered with accurate target, according to Trabucco's experience. Select your own Atomic and bring it to the water: fish will immediately realize who is the leader!

SPECIFICATIONS:



"Y" frame SiC guides. All guides feature SiC ring to provide maximum protection to the line and dissipate heat developed during fish fight. The frame arms join together before form the guide's foot, thus offering extreme stiffness and stop vibrations.



Pacific Bay reel seat. The plate reel seat is made from stainless steel, featuring protections for reel's foot and rubber base. Size 7 to accept big sized reels.

Aluminium butt cap and EVA tower. The nice cap, including a protective rubber insert, is made from aluminium to provide lightness and strength. In order to correctly space the guides when the rod is closed, an ultralight EVA tower has been added in the rod's butt.



Anti-grip joint's finish. The male side of all joints has been finely sanded with computer aided machine to obtain maximum precision. This prevents sticking when joints are wet, while at the same time it grants complete contact, avoiding any vibration.

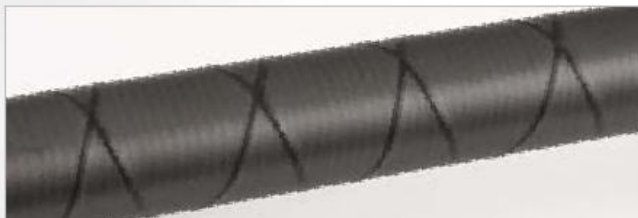

Cross Winding carbon braiding. The whole blank of Atomic bolos, except top section, is wound by an high modulus carbon yarn protects it from accidental shocks. In addition, it contrasts the blank's deformation under heavy load, actually stiffening it.



Goran Radovic

NEW **ATOMIC X2 ALLROUND**

CW CROSS WINDING **SENSI TOUCH** **CX-1 CARBON**

Through the X2 you get into contact with the stunning power which gained the Atomic concept a leading position in the segment of powerful bolos. Capable to cast up to 60 grams rig and lift up to 2 kilos weight, these rods can shock all those who like the strong tractions and consequently check the tackle very well before buying any. The safety is ensured by the carbon cross winding, which binds the blank up to second section, just to leave the top some freedom to develop its action curve. A true



braiding - not to be confused with cosmetic finish - which contrasts the deformations when the rod is heavily loaded and disperse the stress along the blank. Quality components are certainly worth the addition, like Pac Bay plate reel seat (size 7) and SiC medium leg guides with "Y" shaped frame to avoid vibrations during retrieve.

NEW **ATOMIC X4 FORMULA**

CW CROSS WINDING **SENSI TOUCH** **CX-1 CARBON**

A nice blend of strength and balance gives a certain appeal to these new rods, which are sitting in the middle of Atomic range. As a matter of fact, too many Bolognese belonging to "super power" class are perfect on casting ability, but actually show poor balance or difficult handling. With casting weight up to 80 grams and able to lift up to 3 kilos, X4 rods can face the toughest conditions on the river, lake or at sea side without fear, thanks to the CX1 carbon construction, protected by cross carbon braiding. With hooklinks in the range of 0,20-0,25 mm diameter, these rods can really stop those endless runs and lift the fish from

water in case landing net could not be used. Guides are "Y" frame medium leg with SiC ring. Pac Bay reel seat of size 7 to accept big size reels.

Code	Length	C. Length	Weight	Sections	Guides
122-58-500	5.00	140	290	5	SiC
122-58-600	6.00	142	415	6	SiC
122-58-700	7.00	144	520	7	SiC

NEW **ATOMIC X6 FORMULA**

CW CROSS WINDING **SENSI TOUCH** **CX-1 CARBON**

If your favourite fishing condition is not suitable for the most powerful bolo available in the market, you certainly need an Atomic X6! Realistically, these rods can cast up to 100 grams rig and actually lift up to 6 kilos weight, but how many anglers could do so? For this reason, the series is made of 5 and 6 metres length only, as longer ones would have resulted out of control by the user. The rod can deal with sturdy hooklinks around 0,25-0,30 mm in diameter and, exactly like the other X2 and X4, it can be used for light drifting because CX1 carbon wall is assisted by carbon yarn braiding from butt to second section.

Code	Length	C. Length	Weight	Sections	Guides
122-59-500	5.00	142	335	5	SiC
122-59-600	6.00	146	445	6	SiC





Code	Length	C. Length	Weight	Sections	Guides
122-57-500	5.00	129	235	5	SIC
122-57-600	6.00	131	320	6	SIC
122-57-700	7.00	133	410	7	SIC

SPECIFICATIONS:



Guides fitted on top and second section are slightly oversized, to enable silicone stoppers pass through during sliding float's fishing.

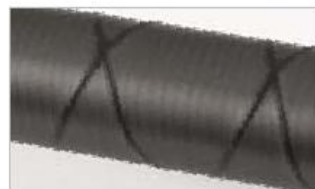

Carbon yarn reinforcement wrapping (Cross Winding).



Reinforced top guides.



NEW TITAN BLS EXTREME



The nice side of Bolognese rods is versatility, as a single one can solve thousands of fishing situations. With rods like these Titan Extreme, it's possible to move from classic float fishing in lake or river to trout fishing with just a lead sinker, or fish at sea with paste bait. The secret of this series is the fantastic balance, which makes every size – including the always tough 7 metres – easily usable with a single hand. This is due to the accurate project, based on CX1 carbon reinforced by Cross Winding, which enable to cast up to a 20 grams float without problems and with no

oscillations. Guides are quite good, with medium leg "Y" frame and SiC ring, as well as the size 6 wrapped plate reel seat.

Code	Length	C. Length	Weight	Sections	Guides
122-61-500	5.00	130	235	5	SiC
122-61-600	6.00	130	325	6	SiC
122-61-700	7.00	132	435	7	SiC



ATTRACTIVE BOLO POWER



Bolognese rod of great balance and equilibrium that allow a safe combat through a rigid action very well distributed along the blank. Powerful, Cross-reinforced Winder, but very precise, able to offer its best where other rods raise the white flag. Excellent fishing for barbel in fresh-water and sea fishing from natural cliffs and harbors. The special coating of the

grip, called Sensi Touch, allows a perfect grip in every situation and a feeling of true comfort. Such a nice product and a such great performances have never been seen before, specially at such a competitive price. Super High Modulus carbon fiber CX-1 blank.

Code	Length	C. Length	Weight	Sections	Guides
120-73-600	6.00	151	360	6	SiC
120-73-700	7.00	151	500	7	SiC



NEW EPICA BSR BOLO



Even though the industry is continuously looking for new solutions to produce pleasant and performing rods, it's not so common to meet something really new and interesting. Once again, Trabucco gives us this opportunity, with this new series of good bolos, featuring an innovative reel seat. It's called Super Light Integrated Reel Seat, and it works like a normal size 6 plate reel seat, but it's not fixed by standard wrappings. In fact, it's integrated in a graphite support, which is glued directly to rod's handle, resulting less bulky and much more stable than a wrapped, plate reel seat. The rod is a strong bolo made from SHMR carbon, nicely wrapped with SiC long leg guides. The whole blank is finished by a

black satin coat, which is actually waterproof, so that it helps casting longer because wet line doesn't stick to the rod's surface.

Code	Length	C. Length	Weight	Sections	Guides
120-28-500	5.00	135	230	5	SiC
120-28-600	6.00	135	300	6	SiC
120-28-700	7.00	135	395	7	SiC





Medium leg guides with "Y" shape frame.

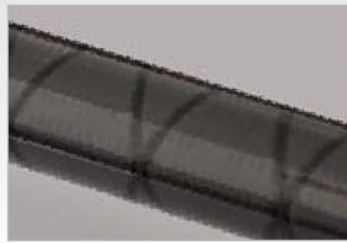

Carbon yarn reinforcement wrapping (Cross Winding).



Plate reel seat size 6 made from steel and rubber.



Stefano Bosi



Marco Busani



The fantastic plate reel seat is integrated in the handle, without any wrapping.



Long leg guides with SiC ring.



Aluminium butt cap with rubber insert.



ACTIVA

NEW ACTIVA STX BOLO

CW CROSS WINDING

SENSI TOUCH

CROSSED REINFORCED

High precision control

S.H.M.R. CARBON

The continuously evolving technology should not take care of high grade tackle only, but also bring the best possible performances to lower layers of the range and make them affordable to everybody. This nice Activa STX proves that Trabucco engineering team knows the job quite well, because the rods show pretty good balance and power, as well as extremely fine details: specifications which are normally confined to top of the range bolos. Compared to existing Activa Bolo, these new rods have been designed with faster taper and reinforced with a carbon spiral up to third section. As a

result, the body is remarkably stiff, and this has allowed the engineers to also include a good seven metres in the series.



Medium leg guides with "Y" shape frame.

Code	Length	C. Length	Weight	Sections	Guides
120-24-500	5.00	135	235	5	SIC
120-24-600	6.00	135	315	6	SIC
120-24-700	7.00	135	380	7	SIC

Carbon yarn reinforcement wrapping (Cross Winding)



ACTIVA BOLO

SENSI TOUCH

CROSSED REINFORCED

High precision control

S.H.M.R. CARBON



Series of Bolognese rods particularly easy to transport because are compact and when closed they are really short. The low diameter blank together with a perfect balance make these rods extremely good and similar to more expensive ones, and they are offered at a nice price. Butt with non-slip finish and equipped with SIC guides.

Code	Length	C. Length	Weight	Sections	Guides
120-26-500	5.00	121	220	5	SIC
120-26-600	6.00	123	282	6	SIC



Marco De Biase

EXXON 2000 / 3000 / 4000 **NEW**



- X-TEA TOUCH BODY
- SUPER NIGHT STI
- MI-SPIDER SPARE SPOOL
- 5.1:1 GEAR RATIO
- 5+1 BB SYSTEM

- Super stiff hi-tech graphite body
- Ultralight aluminium main spool
- Graphite spare spool
- Hollow bail with anti twist line roller
- Double shielded stainless steel ball bearings
- Power Fight aluminium handle

Find out more on page 160

ERION

NEW ERION X-LIGHT BOLO

SS SUPER SLIM BLANK

SENSI TOUCH

CROSSED REINFORCED

high precision control

S.H.M.R. CARBON

It's the light sister of Erion XS Allround, capable to handle finer hooklinks with his balanced softness; with these rods, the most classic Bolognese style – fishing for chub and barbel in the clean, running waters of medium sized rivers – becomes a pleasant job offering exciting experiences. The medium leg guides, with "Y" shaped frame, can actually absorb vibrations during retrieve, limiting abrasion and heating which are the worst enemies for the line. A line which lasts longer is definitely more reliable, and also helps reducing costs. The

special satin finish of the handle is easy to clean and gives a special feeling during fishing.

Code	Length	C. Length	Weight	Sections	Guides
120-27-400	4.00	132	145	4	S-SiC
120-27-500	5.00	134	225	5	S-SiC
120-27-600	6.00	136	295	6	S-SiC

NEW ERION XS BOLO ALLROUND

SENSI TOUCH

CROSSED REINFORCED

high precision control

S.H.M.R. CARBON

These new rods are particularly nice in every detail, as they have been finished with same care normally reserved to high grade models. Consequently, Erion XS impress for the interesting quality/price ratio, a specification which counts a lot in these days, as the general approach is to "enjoy without spending a fortune". A target which has nicely been hit by Trabucco's development team with this high grade carbon blanks, designed under Super Slim concept to offer balanced rods, reliable from structure's point of view and performing in

action. The sliding guide in the middle of second section is quite worth, as it helps distributing load and stress, as well as easing long casts with his specific ability to help line's flow.

Code	Length	C. Length	Weight	Sections	Guides
122-11-500	5.00	140	255	5	S-SiC
122-11-600	6.00	140	380	6	S-SiC

NEW ERION X POWER BOLO

SENSI TOUCH

CROSSED REINFORCED

high precision control

S.H.M.R. CARBON

A very stiff body and a medium soft top area are the main specifications of the Erion Bolo Power action. The first one provides power to cast the float rig at distance and safely drive the big fish to the waiting landing net. The second one takes care of casting accuracy and strike's efficiency. Well programmed roles in a modern bolo, destined to face the lakes and river streams, where it can also easily catch trout, but even the sea rocks. The handle is tapered as much as needed to grant power and strength, without excess in diameters, and is brilliantly dressed by Sensi Touch finish: a fantastic sensation of smoothness and the chance to easily clean

it at the end of a fishing session. Guides are medium-long framed with "Y" shape to avoid vibrations.



Internal screw butt cap.

Code	Length	C. Length	Weight	Sections	Guides
120-29-500	5.00	140	260	5	S-SiC
120-29-600	6.00	145	370	6	S-SiC

NEW REVENTON MASTER BOLO



Placca portamulinello ammortizzata

Entering the world of fishing can actually scare any newcomer, but the role of leading companies like Trabucco is also to ease the tackle choice, showing the smoothest way to get the first emotions with reliable and handy rods, having a balanced quality/price ratio. With Reventon bolos, for example, fishing with float in canals and streams, but also facing commercial lakes or sea ports is a real pleasure. The High Resistance carbon structure can bear any strong cast and pulls, because it's assembled under computer control and well reinforced at joint areas. Guides and reel seat quality have been selected to provide total reliability.

Code	Length	C. Length	Weight	Sections	Guides
120-31-400	4.00	125	150	4	S-SiC
120-31-500	5.00	125	250	5	S-SiC

SYNTIUM BOLO



Rigid action rod with high speed hook setting. Constructed by a "Radial Carbon Technology" and the latest technologically innovative materials to guarantee satisfaction for the most demanding angler. Particularly suited for big fish with medium heavy line both in fresh water and the sea. This rod is not easy at the beginning, especially if you are fishing in deep waters and turbulent flows, but as soon as you take the hand becomes an invaluable ally to fish on that unreachable line... for others!

Code	Length	C. Length	Weight	Sections	Guides
120-18-500	5.00	126	229	5	SiC

ORBITRON vx BOLO POWER



This rod is characterized by limited weight and section diameter. The use of new N.F.T. carbon materials make it well-balanced and light while maintaining a progressive action and reliability. Excellent manageability in all fishing conditions both in the sea or in fresh water. Reliability is guaranteed by the top quality materials used in its construction. Supplied with Super S-SiC High frame ultra-light guides and the new cushion plate reel seat.

Code	Length	C. Length	Weight	Sections	Guides
122-08-500	5.00	130	245	5	S-SiC



Maurizio Fedeli

ERION XS MINI BOLO

SENSI TOUCH CX-1 CARBON

Let's face it: a handy and compact rod, you can leave in the car and that is not only easy to use but first of all reliable, it is a rod that is interesting for everybody. So this is not a rod for specialists but a rod which finds its use in the stream as in the pond, river or at sea. The high resistance carbon is a guarantee of total reliability, forgiving the mistakes of beginners, but also guarantees lightness and precision. The ringing S-SiC quickly disperses the heat, and allows the safe use of even very thin monofilaments.

Code	Length	C. Length	Weight	Sections	Guides
124-83-320	3.20	63	120	7	SiC
124-83-360	3.60	64	150	8	SiC
124-83-400	4.00	66	190	9	SiC
124-84-340	3.40	65	160	7	SiC
124-84-380	3.80	66	185	8	SiC



ANTRAX BLS STREAM

SENSI TOUCH CROSSED REINFORCED high precision control

Compact and short elements Bolognese rod. It can be used in a number of situations thanks to their easy handling and reliability, really at the top. The high resistance carbon fibers make the blank not only lightweight but also strong enough to fight whatever fish will bite at your bait.

Code	Length	C. Length	Weight	Sections	Guides
124-80-380	3.80	104	175	5	S-SiC
124-80-450	4.50	108	230	6	S-SiC



ORBITRON FX

SENSI TOUCH CROSSED REINFORCED high precision control

These rods are made using a new procedure which allows the combination of H.R. Carbon and Powerfibre. Easy to transport, these rods can be used for trout fishing in reservoirs and streams, even with heavy rigs. The Orbitron FX is really versatile and if necessary can be used as Bolognese when fishing for carp. All the rods are equipped with S-SiC guides and premium quality reel seat.

Code	Length	C. Length	Weight	Sections	Guides
124-74-300	3.00	72	145	5	S-SiC
124-74-350	3.50	74	195	6	S-SiC
124-74-400	4.00	77	245	7	S-SiC



TELEMATCH

Telescopic Match rods are notorious because they are easy to use. Actually you cannot find any other rods as powerful, reliable, handy and amusing than a 3 pieces match rod but... thanks to some new technology innovations and careful design that we need have no qualms about telling you that our telescopic match rods feature almost the same specs of 3 pieces ones. In the next pages you will see rods with super casting specs, super powerful actions and super sensitive ones, with a wide range of casting powers, developed

both for fresh and salt water fishing. All of these rods will satisfy your needs and increase your fishing experience. Compare Trabucco rods with our competitors rods and you will see the Trabucco ones are always the best at a given price. You are looking at the best of our 2015 production, so judge by yourself and remember: before to buy a telescopic match rod, ask your favourite shop to show you a Trabucco telescopic match for the same price. You will prefer it for sure.



NEW VANADIA XT-MATCH

Among the vast population of telematch lovers, many are those who prefer the carbon handle instead of traditional cork one. That's why Trabucco also offers rods like Vanadia XT, which show an impressive Super Slim butt considering the tremendous power it can deliver. The concept seems to push these rods into Bolognese fashion, but once in your hands, it's clear that the slightly upper reel seat is there to help you push as much as you like. In line with such need, the body of these rods is engineered to be heavily loaded, thus boost heavy wagglers to the horizon. The job is done by CX-1 Micro Pitch carbon, whose structure is so tight that the blank's answer is strong and neat, without oscillations. The blank is further powered and protected by a cross winding carbon yarn, which is purposely missing on top section to generate a perfect action curve. A great feeling comes from Sensi Touch finish of



handle area, proving the Trabucco's attention to details. Guides are short leg HD model, able to quickly disperse heat caused by the endless line flow, an essential part of waggler fishing.



Blanks made from Micro Pitch Carbon CX-1 (Super Slim).



Medium leg HD guides (quick heat dissipation).

Code	Length	C. Length	Weight	Sections	C.W.	Guide
150-34-450	4.50	130	202	7	10-60	SiC
150-34-455	4.50	130	208	7	20-80	SiC





ATTRACTIVE T-MATCH ALLROUND

The T-MATCH ATTRACTIVE ALLROUND is produced in three 4.50 meters models to meet the widest range of power and casting requirements. They don't fear any comparison in terms of toughness and are suitable for challenging fishing styles, when it often comes to lift the fish instead of use the landing net. The blanks, made of super high modulus CX-1 carbon are further enhanced with carbon filaments over the whole length but the tip. High quality components: SiC guides, shock absorber reel seat and non slip rubber painted handle.



Carbon yarn reinforcement wrapping.



Colour coded wrappings to identify actions.



Medium leg SiC guides.



Shock absorber reel seat and non slip rubber painted handle.



Code	Length	C. Length	Weight	Sect.	Azione	C.W.	Guide
150-30-100	4.50	130	195	7	MH	10-30	SiC
150-30-200	4.50	130	202	7	H	20-50	SiC
150-30-300	4.50	130	210	7	HH	30-80	SiC



NEW TITAN TELEMATCH

In a segment often dominated by boring design, with rods often looking all similar, only Trabucco's know-how could have changed things and stand up above the rest. Now his R&D team does it with new Titan, the most sensitive telematch rods around. Everybody knows that the rod's power comes from the body, while casting accuracy and hook setting are provided by top and second section, specially when top tip is remarkably fine, as on Titan Telematch. When the rod is employed on lake trout fishing or with bombarda at seaside, this is even more evident, because fish's bite is made evident by the rod's tip. Then, control and sensitivity become vital ingredients of success, so an important role is played by the wonderful Sensi Touch reel seat, which fits into the user's hand like a tailor made glove. Both thumb and fore finger get into direct contact with rod's blank, sending to brain an intense feeling of superior efficiency and perception.



Code	Length	C. Length	Weight	Sections	C.W.	Guide
150-32-420	4.20	129	275	7	30	SiC
150-32-450	4.50	131	280	8	50	SiC



SELEKTOR T-MATCH

We received many requests for a tough and reliable value for money telescopic match rod. We then created the Selektor T-Match series, a full range of rods having several length and casting weights suitable for many situations. The blank is made of Super High Modulus Radial Carbon, hardened and strengthened by the special Cross Winding technology, consisting in a double carbon ribbon criss-crossed along the whole length of each section. The rod is very fast during casting and able to strike rapidly. These rods are not expensive but they are equipped

Code	Size	C. Length	Weight	Sections	C.W.	Guide
151-92-420	4.20	129	315	4	10-30	SiC
151-92-425	4.20	129	330	4	20-60	SiC
151-92-450	4.50	137	360	4	10-30	SiC
151-92-455	4.50	137	380	4	20-60	SiC

with very good components, such as SiC guides, natural cork handle with EVA inserts and ergonomic reel seat.



ORBITRON NRG MATCH



Blank made of SHMR carbon further reinforced with the use of Cross Winder technology that uses a winding of carbon wire distributed throughout the whole length of the rod. This is a so versatile rod, with excellent technical features exploited by those who likes match fishing for trout in the lake, fishing from the rocks on the sea and even by those who fish from the boat. The series consists of three actions distributed in two lengths 4.20m and 4.00m. Rods equipped with S-SiC guides, shock absorber reel seat and non slip paint on butt section.

Code	Length	C. Length	Weight	Sections	C.W.	Guide
151-87-405	4.00	129	268	5	8-25	S-SiC
151-87-420	4.20	133	320	5	10-30	S-SiC
151-87-425	4.20	133	330	5	20-50	S-SiC

REVENTON T-MATCH



Powerful telescopic match series with fast action, very effective when striking. The strong blank is able to cast big floats and bombards up to 50 grams. Power and reliability have been got using the carbon fibres in a wise way, so they can stand every bending, both vertically than horizontally. The Reventon T-Match are the ideal rods to be used all the times there is

the possibility to hook very big fish and the need to cast further.

Code	Length	C. Length	Weight	Sections	C.W.	Guide
151-93-360	3.60	111	240	5	50	S-SiC
151-93-390	3.90	124	260	5	50	S-SiC
151-93-420	4.20	124	335	5	50	S-SiC

ERION XS MATCH ALLROUND

Most probably, the telematch rod is the emblem of versatility in the Italian fishing scenery, and that's why it has deserved a pretty good reputation in most European countries as well. Beyond the natural waggler fishing, it can solve thousands of problems both in fresh and saltwater fishing. It can catch lake trout as well as river trout with lead sinker and earthworms. It can cast floating bombardas for surface fishing at sea side, but it's also powerful enough to serve paste bait to grass carp and drive them to the landing net. We have seen it light drifting from the boat for mackerel, and even used as heavy feeder for barb, as the tubular top is equally at home in fast running rivers. Therefore... the "allround" nickname is welcome and appropriate, as used by Trabucco engineers for their new Erion XS, which they designed to be strong and powerful to resist everything, including the injuries coming from the newcomer's rough hands!

Code	Length	C. Length	Weight	Sections	C.W.	Guide
151-94-400	4.00	124	275	5	10-80	S-SiC
151-94-420	4.20	128	328	6	10-80	S-SiC



SYNTIUM TELEMATCH

**S.H.M.R.
CARBON**

Cast, cast and still cast. This is the test that has undergone this product at the design stage. The purpose of this rod was long casting and consequently the design efforts were focused in that direction. We have used SHMR Carbon with a special reinforcement named W-



Power. This allow a newbie too to cast a waggler as far as 90 meters! These rods are so powerful and resistant you can even lift big fishes with no problem when fishing in salt water, from rocks or piers. The range covers all the different actions and

enables fishing with many different weights and size of waggler floats. Before buying an match rod of any competing brand, ask your dealer to let you try one of our rods of the same price range. At that point you will have no more doubts.

Code	Length	C. Length	Weight	Sections	C.W.	Guide
151-89-400	4.00	116	247	4	40	SiC
151-89-405	4.00	116	262	4	60	SiC
151-89-420	4.20	116	315	5	80	SiC



Mario Baptista



MATCH RODS

When an Italian Company sells match rods to the UK Market, it means that these rods has been designed really well: this is the result obtained by Trabucco. Our UK consultants provided all the essential elements to create a product that respects tradition and technique, then the team of Italian champions have managed to combine these features with all the needs

for fishing in continental waters, and finally gave Trabucco the latest manufacturing technologies on the market. Finally the results is an unrivaled range of match rods able to provide highly specialized and appropriate rods. Does not exist a company with such a vast range of match rods.

ENERGHIA 2K MATCH POWER



The 2K Match Power complete the wide Energhia range, without any presumptions, the most beautiful and famous match rod series in the world. The blank, made from High Modulus Radial Carbon, can develop the power to shoot 30 grams wagglers up to 100 meters away. In this model we have applied the latest technology, research and design available. Superb components and finishes: Fuji guides, Fuji reel seat and AAA cork handle. This rod is dedicated to all those who want to complete their series of Energhia match rods.

Code	Length	C. Length	Weight	Sections	C.W.	Guide
153-21-450	4.50	155	200	3	10-30	Fuji A

Engineering

ENERGHIA

2K MATCH POWER

MATCH POWER

MATCH POWER

MATCH POWER

MATCH POWER

MATCH POWER

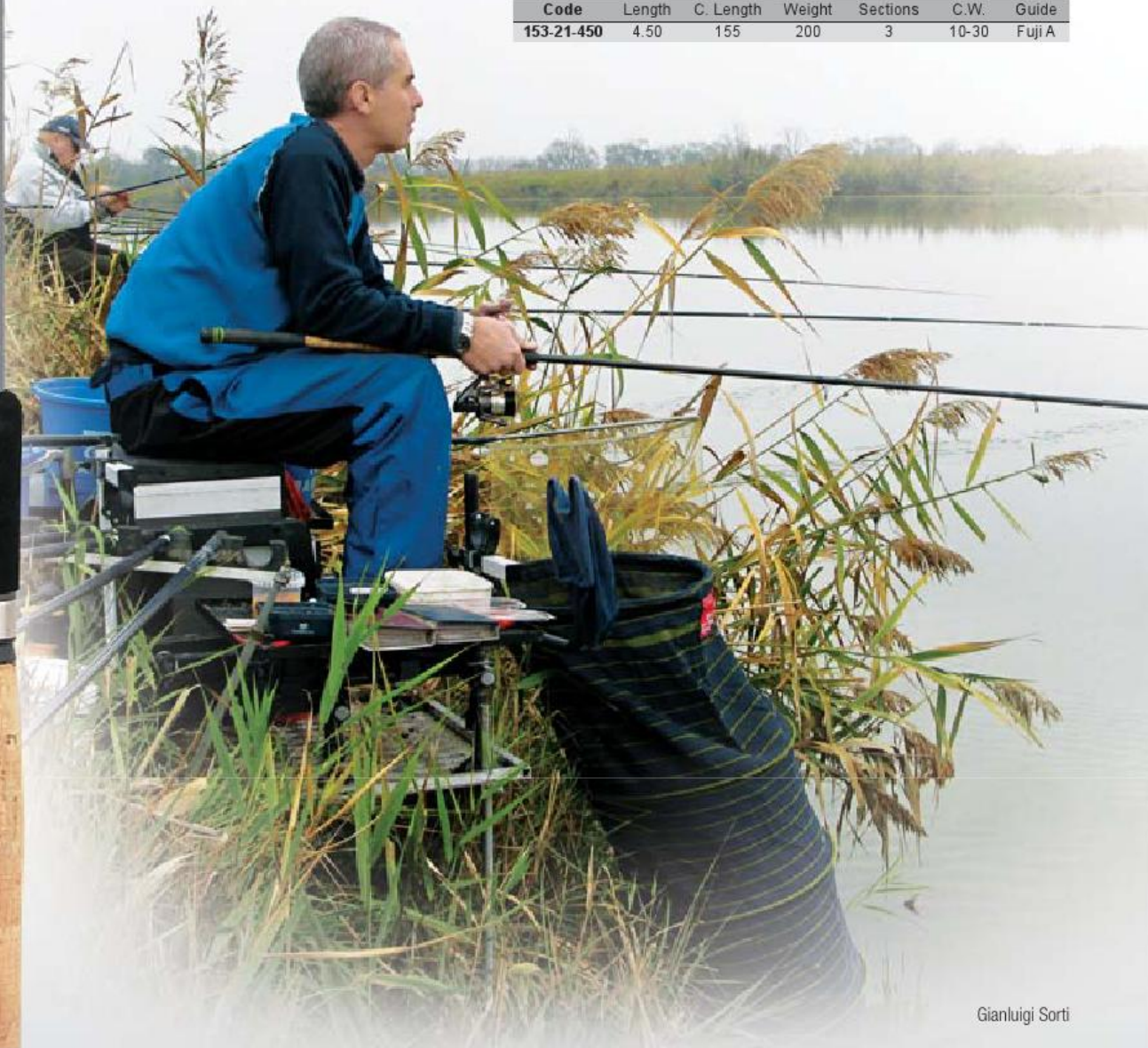

Gianluigi Sorti

ENERGHIA 2K

ENERGHIA 2K MATCH PLUS



We do believe to have built the best match rod in the world: no gimmicks and no compromises. And we also decided to ignore the price! Yes, it costs but it is worth every single cent you spend for it! Countless testing hours, the best materials on the market, the best technology, all of this is included in the two models. For sure it is not a rod for everybody, unexperienced anglers won't get even the 50% of these rods potential.

But serious and experienced anglers will have in their hands rods able to cast very very far and very accurately. Super slim High Modulus Radial Carbon blanks, light as a feather, equipped with genuine Fuji guides and reel seat, AAA cork handles. The most impressive qualities are the incredible tip action and a progressive blank that no other brand can match. If you try them you will fall in love. We give you our word!

Code	Length	C. Length	Weight	Sections	C.W.	Guide
153-18-450	4.50	155	200	3	8-25	Fuji A
153-18-480	4.80	165	225	3	10-30	Fuji A

ENERGHIA 2K MATCH



The 2K Plus serie was missing of a 4,20 meters model and so we decided to build it. The blank has been built in Super High Modulus Radial Carbon and equipped with genuine Fuji Alconite guides and cork with EVA inserts handle. When you start using this rod with a 10-15 grams waggler you can really understand the essential quality of this

project. Even if it is the shorter of the 2K Plus, it can cast as far as the others and with the very same accuracy. And when fighting the fish this rod is even more amusing. If you want to push your limit, take this rod and you will discover a new world in match fishing.

Code	Length	C. Length	Weight	Sections	C.W.	Guide
153-18-420	4.20	144	155	3	5-20	Fuji A



Handle Energhia 2K Match



Handle Energhia 2K
Power and Match Plus



SYGNUM MRX-V



SYGNUM XS PROLITE

Prestige rods series with slim diameters and lightweight blanks, made using the Carbon Nano Technology. This model has a progressive action and is able to cast a wide range of weights at long distances. Well suited for fishing with thin monofilament even if bigger diameters are well supported. Fitted with new T-Sic Ultra-Light guides and a new concept reel seat and cork handle.

Code	Length	C. Length	Weight	Sections	C.W.	Guide
157-69-420	4.20	145	172	3	5-20	SiC
157-69-450	4.50	155	195	3	5-20	SiC



SYGNUM MRX-V



The new SYGNUM MRX-V is a really complete series of rods designed to cover all the demands of modern fishing methods. From small lakes to river fishing for chub, barbel and bream or in commercial fisheries that require long distance casting with heavy wagglers. We used Super High Modulus Carbon perfectly to get the necessary stiffness for long and precise casting and the essential flexibility for catching big fish with low diameter lines and light tackle. Manufactured with the very highest quality materials and finishing such as the high grade cork handle, genuine Fuji reel seat and S-Sic guides.

Code	Length	C. Length	Weight	Sections	C.W.	Guide
151-19-390	3.90	136	198	3	3-15	SIC
151-19-391	3.90	136	203	3	5-20	SIC
151-19-392	3.90	136	206	3	8-25	SIC
151-19-420	4.20	145	215	3	5-20	SIC
151-19-421	4.20	145	218	3	8-25	SIC



Stefano Bosi

SYGNUM TLD

This rod has been designed for waggler fishing. Fully made of High Modulus Carbon and equipped with Super S-SIC Light Frame Guides and a new design ergonomic natural cork handle for better grip. The new concept new reel seat is also used. Featuring an extremely small diameter blank, the casting weight varies according to length and ranges from 5 to 30 g. Typical progressive tip action gives power for casting long distances with the required accuracy. The 4,50 H action is just perfect for super long casting and big fish, while the 4,50 MH is a true allround rod.

Code	Length	C. Length	Weight	Sections	C.W.	Guide
157-66-450	4.50	155	250	3	8-25	SIC
157-66-455	4.50	155	250	3	10-30	SIC



SYGNUM XT



SYGNUM XT WAGGLER



Designed for waggler fishing and available in 13' length this rod is constructed with the new SUN SCREEN FINISH and uses Super High Modulus Carbon with High Resistance Carbon reinforcement in the stress points to increase overall reliability. Equipped with long leg SiC Light Frame guides, ergonomic reel seat mounted on natural cork and high density EVA handle. Perfect action - progressive and very powerful. Extremely manageable and light, ideal for up to 12 g wagglers and for either low diameter line or heavier duty line for a large fish.

Code	Length	C. Length	Weight	Sections	C.W.	Guide
151-22-390	3.90	138	148	3	3-12	SiC

SYGNUM XT POWER



This 13' Sygnum XTPower Waggler is assembled with SiC Light Frame guides, ergonomic reel seat mounted on natural cork and high density EVA handle. It features a progressive action for long, precise casting with medium-heavy weight. It is the perfect rod for carp and bream over medium to long distances. Its slim diameter blank increases the lightness and manageability of the product without compromising reliability. High quality finishing and components.

Code	Length	C. Length	Weight	Sections	C.W.	Guide
151-23-390	3.90	138	145	3	5-15	SiC

SYGNUM XT POWER PLUS



A step up from the Power version the Power Plus Waggler rod comes in 13' and 14' lengths. Assembled with SiC Light Frame guides, ergonomic reel seat mounted on natural cork and high density EVA handle. Progressive action for long, precision casting with medium-heavy weight up to 20 gr. Designed for speed fishing, that is when there is a great quantity of fish and you need a very good casting accuracy and a good power to reel in preys very fast. The action is also good to face bigger fish.

Code	Length	C. Length	Weight	Sections	C.W.	Guide
151-24-390	3.90	135	174	3	5-20	SiC



Alessandro Bruni

ERION XT CARP PRO



Match fishing rods built with great accuracy, created for fishing big fish also at long distance. The reliability of the blank has been obtained by using super high modulus carbon Durawall, which is not only super strong but it is also remarkably light weight and sensitive. EVA and cork handle is particularly comfortable. Equipped with SIC guides for better heat dissipation.

Code	Length	C. Length	Weight	Sections	C.W.	Guide
151-47-390	13' - 3.90	137	204	3	8-25	SIC
151-47-420	14' - 4.20	145	232	3	8-25	SIC

ERION XT MATCH PRO



Made from super high modulus Durawall carbon and fitted with Sic. The blank is slender, while the action is progressive, providing long cast performance and being always ready to fight the fish. These rods are equipped with ergonomic reel seat and cork with EVA inserts butt section. Two actions designed for easy fishing for fish carp, bream and crucian carp.

Code	Length	C. Length	Weight	Sections	C.W.	Guide
151-56-420	4.20	145	248	3	5-20	SIC
151-56-450	4.50	155	259	3	8-25	SIC

PRECISION CARP MATCH



This rod available in 13' length, is designed to be suitable for waggler fishing for large carp and other hard fighting fish. Its very slim diameter combined with the stiff but progressive action allows for long distance casting and excellent fish playing characteristics. Constructed entirely in HM carbon, and fitted with Super SIC Light Frame guides, natural cork and EVA anti-slip handle and anatomical new reel seat.

Code	Length	C. Length	Weight	Sections	C.W.	Guide
157-58-390	3.90	135	190	3	5-20	SIC



SYNTIUM MATCH PLUS



The great commercial success of these all-round rods, usable in all situations, has imposed a widening of the range with the introduction of a 4.50m with 30 grams casting power. The blanks are sturdy, made of SHM Durawall carbon with Reinforced Crossed technology. The action, shared by the two sizes, is tip action with large reserve of power. Perfect choiche to fish for carp, bream, crucian carp and even chub, with extremely small

SYNTIUM MATCH CARP



These two rods are born for carp fishing. Two different lengths having the same casting power: 5-20 grams. Made using Super High Modulus Durawall Carbon with Crossed Reinforced technology. Equipped with Power Joint system to avoid blocking sections, Super S-Sic Light guides, natural cork and EVA antislip handle and ergonomic reel seat. Recommended for top water

SYNTIUM CARP PLUS



Super powerful rods developed in two sections with two different lengths (3.00 and 3.30). As for the whole series Syntium all the blanks are very thin because they are made in Super High Modulus Durawall Carbon but at the same time very powerful and reactive. Crossed Reinforced and Power joint to avoid blocking sections. Assembled with SiC Light frame guides, natural cork and EVA anti-slip handle. These two pieces rods are very funny and very pleasant to use. Two rods born to catch a lots of fish in a short time!

XD MATCH FLOATS SERIES

The Trabucco XD match floats, where XD stand for perfection and are individually hand made with maniacal accuracy. They equipped with a carbon tube to increase stability and sensitivity, having a lower diameter if compared to a traditional peacock quill. They are the ideal choice for long distance fishing in canals and lakes for difficult fishes like crucian and breme. The HD floats are sol with two interchangeable tips of different diameter.



Find out more on page 258



diameters lines. Lightweight frame SIC guides and cork with EVA inserts butt section.

Code	Length	C. Length	Weight	Sections	C.W.	Guide
151-59-390	3.90	137	179	3	8-25	S-SIC
151-59-420	4.20	145	198	3	10-30	S-SIC
151-59-450	4.50	155	213	3	10-30	S-SIC



carp fishing in commercial fisheries or for long distance fishing in big lakes.

Code	Length	C. Length	Weight	Sections	C.W.	Guide
151-61-330	3.30	116	179	3	5-20	S-SIC
151-61-360	3.60	127	190	3	5-20	S-SIC



Code	Length	C. Length	Weight	Sections	C.W.	Guide
151-62-300	3.00	155	163	2	5-20	S-SIC
151-62-330	3.30	168	176	2	5-20	S-SIC



Maurizio Fedeli



Goran Radovic

XPS MATCH SINKING

Japanese production monofilament made especially for waggler or feeder fishing. The main feature of this innovative monofilament is its high specific weight which allows it to sink extremely easily. Special surface treatment ensures high abrasion resistance and total absence of memory, both fundamental for this type of fishing where the line is subject to great stress.



Find out more on page 199

PRECISION XT MATCH PLUS



Series of two powerful rods made of Super High Resistance Carbon. The rods are very well finished, using ergonomic reel seats, ultra light S-SiC guides and natural cork with EVA inserts handles. The action is powerful but can be easily calibrated, being effective even when using light rigs. The casting power is very good (30g)



Maurizio Fedeli





for 4.20m model), and very good is the sensitivity as well. We designed a peculiar very thin tip section and a conical blank to get the sensitivity we needed. It an easy to use match rod suitable for fishing at medium and long distance targeting breme, carp and crucian.

Code	Length	C. Length	Weight	Sections	C.W.	Guide
152-30-390	3.90	137	186	3	8-25	S-SiC
152-30-420	4.20	145	220	3	8-25	S-SiC
152-30-450	4.50	155	249	3	10-30	S-SiC

PRECISION XT MATCH CARP



This is a really powerful but funny series. The blank has been designed using a conical shaped design, getting a tip-progressive action. If you take these rods in your hands you can clearly understand how handy they are and the power built inside the whole blank, able to calm down the more challenging fish. We suggest you to choose your model upon your casting needs: the longer the cast, the longer the rod. Precision

Match Carp are equipped with S-SiC guides and natural cork with EVA inserts handle.

Code	Length	C. Length	Weight	Sections	C.W.	Guide
152-31-360	3.60	126	182	3	5-20	S-SiC
152-31-390	3.90	137	210	3	5-20	S-SiC
152-31-420	4.20	145	235	3	5-20	S-SiC



PRECISION XT ALLROUNDER



These are true allround rods, being able to cast very far and to fight huge fish. Precision Allround and made also for speed fishing, very useful when you need to land your fish in the shorter time possible. Coming back to its casting skills, when we state it is able to cast very far, we really mean very far: as far as over 100 m with 40 or 60 g wagglers (depending on the model you are using). This exceptional results can be obtained only using very good materials such as the Super High Resistance Carbon Durawall, the stronger, tougher, more reliable Carbon on

the market, in combination with reinforced joints between sections. The rod uses wider S-SiC guides and a natural cork handle.

Code	Length	C. Length	Weight	Sections	C.W.	Guide
152-32-360	3.60	126	158	3	15-40	S-SiC
152-32-365	3.60	126	163	3	20-60	S-SiC

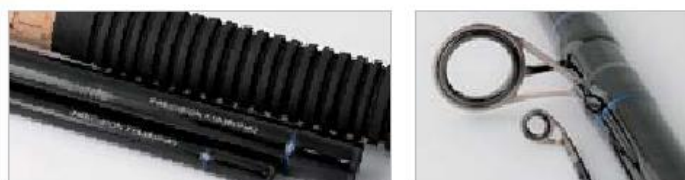

SPECIALIST FEEDER

If we consider fishing like a science branch, feeder fishing is one of the most relevant. All over Europe this is one of the most popular techniques, maybe because with this technique you can fish eve-

rywhere, where other techniques are failing or it is impossible to fish. So the passionate feeder anglers are countless and requiring always more advanced, specific and performing rods. No other brand is

SYGNUM

SYGNUM MRX-V FEEDER



Series of top quality and high value feeder rods, suitable for the European market. All these rods offer unbelievable quality and are made of High Modulus Carbon and finished with heavy duty SiC guides and genuine Fuji reel seat. Well balanced and lightweighted these rods still have enough power reserve to fight bigger fish. Sygnum Mrx-V comes with 3 carbon quiver tips, suitable for both light feeder fishing and heavier feeders. good for commercial fisheries.

A so complete, performing and well finished series of rods that will deeply impress all the anglers that will test them.



Comes with tips:
Quiver 11M 3/4. 1. 1 1/2 Oz
Feeder 12M 3/4. 1. 1 1/2 Oz
Feeder 13MP 2.3.4 Oz



Integrated reel seat and natural cork handle.



These rods are equipped with braid resistant SiC guides.



Sections identified by screen printings.

Code	Model	Length	C. Length	Sect.	Actions	C.W.	Guide
151-16-330	Quiver	3.30	115	3+3	M	75	SiC
151-16-360	Feeder	3.60	125	3+3	M	75	SiC
151-16-390	Feeder	3.90	135	3+3	MP	125	SiC

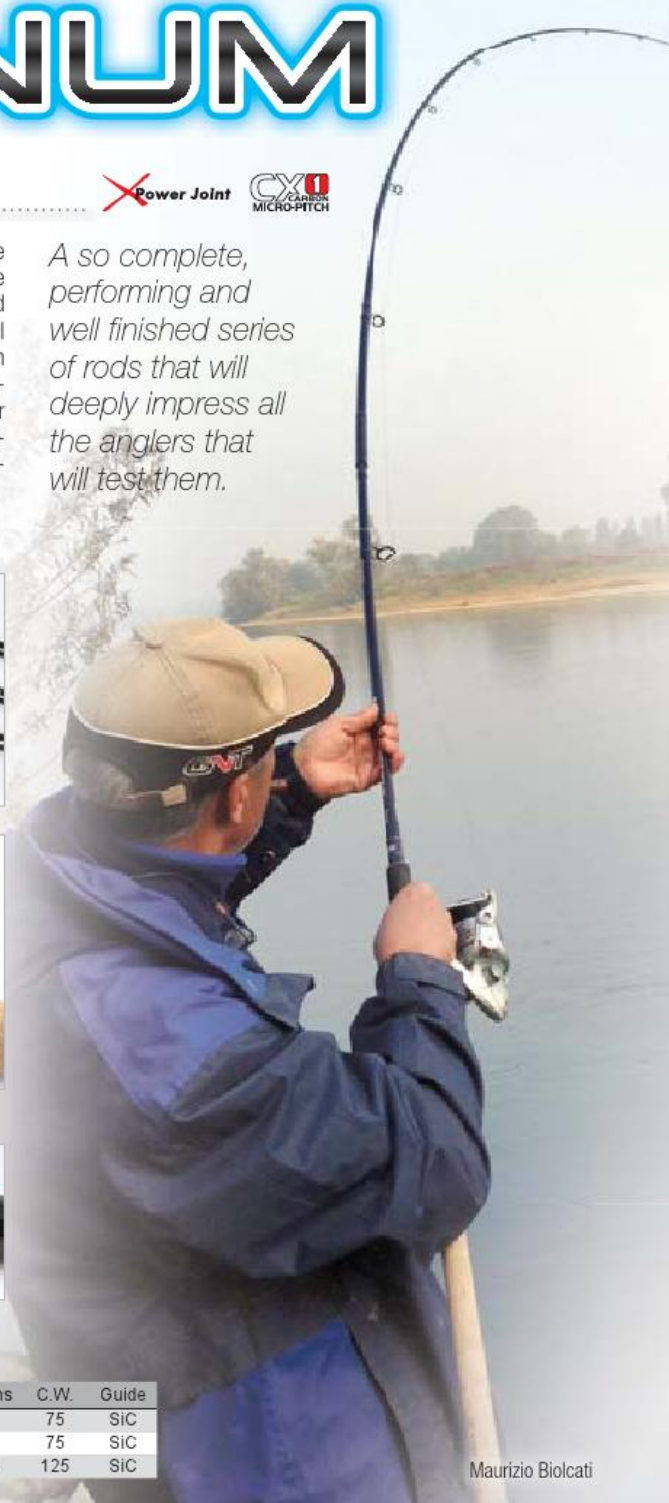

Maurizio Biolcati

offering a so high number of specific rods, equipped with the higher grade components. Trabucco worked really hard to develop such products and we are proud of our products. Check Trabucco feeder rods in the shops and you will understand what we mean.

NEW SYGNUM XPS COMPETITION



Feeder fishing is booming all over Europe as well as in Italy, and anglers grow both in number and skills. Consequently, also the demand is changing, with rods getting more and more specialized to handle a certain type of feeder, to face a definite sort of water or even to expressly suit a particular match venue. This is possible at Trabucco team, because the technicians can easily transfer their individual experiences into performing rods as soon as they feel it's time to create a new one. Top of the range Sygnum now expands

with two special XPS Competition models featuring an impressive compromise between casting power and blank's lightness. A 12' with 90 grams casting weight and a 13' able to handle 125 g heavy feeder, both supplied with 4 quiver tips to allow accurate sensitivity according to conditions, because even the beefiest set-up can sometimes require a fine sensitivity. The wonderful SiC guides can handle braided lines without fear, while the classic cork handle with reliable screw reel seat offers plenty of control.



Rods supplied with four quiver tips. One fiberglass (Ultralight) and three carbon (Light, Medium, Heavy).



Double leg MN SiC guides (single leg on top section).



Spiral wrapping on joints. Screw reel seat made from steel and rubber. Cork handle with EVA fore grip and hybrid cork butt cap.

Code	Length	C. Length	Sections	Actions	C.W.	Guide
151-02-360	3.60	125	3+4	MP	90	SiC
151-02-390	3.90	134	3+4	MP	125	SiC

SYGNUM XPS FEEDER



These excellent feeder rods really stand up from the crowd due to their incredible strength and power, perfectly distributed all over the blank. It is hard to give you a suggestion about where to use them, cause they can match so many situations: you can fish big breme in canal, powerful barb in the river and huge carp in the lake. Sy-

gnum XPS Power Feeder comes with 3 solid carbon tips, sensitive and powerful. These rods are equipped with braid resistant SiC guides, integrated reel seat and natural cork handle.

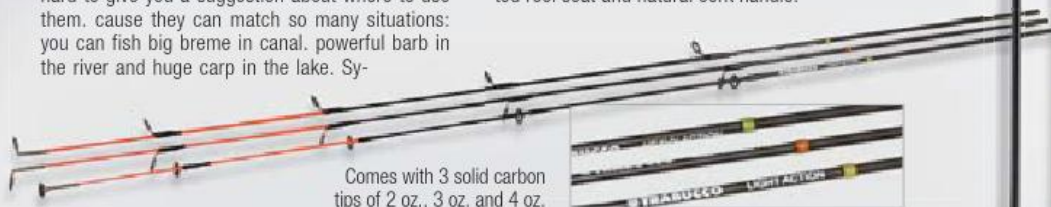

Comes with 3 solid carbon tips of 2 oz., 3 oz. and 4 oz.

Code	Length	C. Length	Sections	Actions	C.W.	Guide
151-11-390	3.90	137	3+3	XP	150	SiC
151-11-420	4.20	146	3+3	XP	150	SiC



NEW SYGNUM TXL SUPREME FEEDER



Among competition rods, the feeder ones are those who must face the toughest life, because they must bear tremendous loads while casting and strong pulls while fighting big fish such as carp, barbel and even catfish. All of us like those exciting catches, but also like light and slim rods, apparently not compatible with those fast running beasts. But it's Trabucco know-how and technology which comes into play to let both worlds live together. Advanced CX-1 Micro Pitch carbon provides lightness and sharpness, while a carbon yarn braiding protects the blank from risky deformations and odd shocks. Such cooperation is so effective that pushes blank's responsiveness beyond any limit: when it's time to put our bait out there to reach those shy fish, it's just a matter of loading the blank and look at the feeder fish. Magic!

Code	Length	C. Length	Sections	Actions	C.W.	Guide
150-90-360	3.60	125	3+4	M	75	SiC
150-90-365	3.60	125	3+4	MH	90	SiC
150-90-390	3.90	134	3+4	MH	90	SiC



Natural cork handle with EVA handle grip. Screw reel seat made from steel and rubber. Blanks reinforced by carbon braiding.

SYGNUM TXL ADVANCED RIVER



Feeder fishing in big rivers always require longer rods, to take away your line from water pressure as much as possible. In this way you avoid also the line dragging too much and avoid the risk of friction against the rough bottom. We designed these rods specifically for big rivers and decide to go for 3.90, 4.20 and 4.50m length. Each rods is equipped with 3 tips (light, me-

dium and heavy action), each of them very well calibrated for casting heavy feeders. The whole blank has been made of the brand new Cx-1 Micro Pitch Carbon, reinforced in every joint for added reliability. The rod is finished with ergonomic EVA handle and braided friendly SiC guides, double leg guides for second and third section, single leg for tips and first section.

Code	Length	C. Length	Sections	Actions	C.W.	Guide
151-13-390	3.90	134	3+3	H	160	SiC
151-13-420	4.20	146	3+3	H	160	SiC
151-13-450	4.50	156	3+3	H	160	SiC

SPECIFICATIONS:

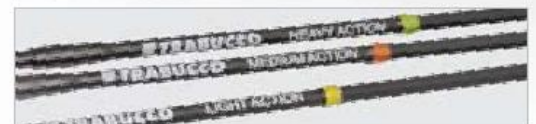

Three tips complete the equipment.



From now, TXL Long Distance is supplied with a fourth tip, having ultralight action for long range bream fishing with braided mainline.



The spiral wrapping reinforces both joints and provides grip to help dismantling rod's sections.

SYGNUM TXL LONG DISTANCE



These are light weight, well balance and super casting rods. We designed these rods for fishing huge barb in big rivers, using feeders up to 100g. Of course they can be used in canals and lakes whenever you need to cast a method or an open

end feeder at very long range. The super slim blank is made of CX-1 Micro Pitch Carbon, super light and high performance. The equipment includes braided friendly SiC guides double legs. The three tips have single legs guides.

Code	Length	C. Length	Sections	Actions	C.W.	Guide
151-14-390	3.90	134	3+4	H	130	SiC
151-14-420	4.20	146	3+4	H	130	SiC





Andrea Caruso

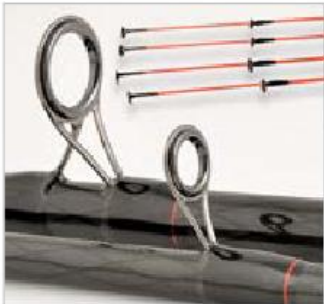

SiC guides enable to use Sygnum TXL rods with braided lines.



Rods equipped with 4 quiver tips: one fiberglass Light action and three carbon quiver, Medium, Medium-Heavy, Heavy.

INVICTUS

2500 / 4000 / 5000



- Aluminium hollow bail
- Spare aluminium spool (match type, featuring a rubber band)
- Sealed drag to avoid water, salt and dust getting inside
- Stainless steel double shielded ball bearings
- CNC handle, machine cut from a single piece of solid aluminium



Find out more on page 148



SELEKTOR



Raffaele Mapelli

NEW SELEKTOR
XS MASTER FEEDER

Power Joint CX-1
MICRO-PITCH

This new series has been developed to give a professional answer to demanding match anglers, who mostly fish for bream. As known, the species has a delicate mouth, which require soft action rods to avoid those hook pulls which can scare the shoal and cause dangerous highs and lows in catching rate. The cooperation from rod's blank is also important when fishing at range with braided lines, specially in case of bonus fish fight. All these characteristics are easily detected as soon as the rod is in your hands: the high modulus CX1 Micro Pitch carbon - assembled with minimum amount of resin - gives the blank a magic blend of lightness and sharpness, while it bends smoothly if you try to pull the tip. The three quiver tips are made from solid carbon to provide precision and neat hook setting, even if the size is down to 20 or 22. The cork handle is nicely shaped at bottom end to offer grip and control during accurate casts: a typical competition feature which is well appreciated also by pleasure anglers.

Code	Length	C. Length	Sections	Actions	C.W.	Guide
152-55-330	3.30	118	3+3	M	75	SiC
152-55-360	3.60	128	3+3	M	75	SiC
152-55-365	3.60	128	3+3	MH	90	SiC

SELEKTOR
XS CARP FEEDER

Power Joint CX-1
CARBON

The blank of this series has been designed to redistribute in a progressive way along the whole blank way all the power coming from the run of a big carp. When fighting these powerful fishes it is very important that the rod can absorb the shock with a perfect bend to avoid to break the line or hurt the fish mouth. The best combination is with a medium-heavy feeder for canal and lake fishing. The blank is made of Super High Modulus Carbon Durawall. Three tips complete the equipment, with three different actions but with the same high visible red colour and wrapping of last guide of different colours for quick identification. SiC guides, ergonomic reels seat and natural cork with EVA inserts handle.

Code	Length	C. Length	Sections	Actions	C.W.	Guide
152-52-360	3.60	126	3+3	MH	90	SiC
152-52-390	3.90	134	3+3	MH	90	SiC



NEW SELEKTOR XS MULTI FEEDER

MULTI LENGTH SYSTEM

Power Joint

CX1 CARBON MICRO-PITCH

An interesting solution allows to expand rod length by one foot, just in case you opt for a longer rig, or you must deal with water flow getting progressively faster through the match or during a pleasant fishing session. Just add the 1' extension and the rod will be immediately adapted to changing conditions, allowing to stay in contact with feeding fish. Therefore, two rods performing like four actually open a new world to the careful angler, allowing him to face canals, lakes and rivers with same nonchalance. Apart from this outstanding versatility, the Selektor XS Multi Feeder has brilliant blanks made from high modulus CX1 carbon, and

is supplied with three carbon quiver tips, all made from carbon. Light, Medium, Heavy.



Natural cork handle with hybrid cork butt grip. Screw reel seat made from steel and rubber. Spiral wrapping on joints. Double leg SiC guides.



Rods equipped with 3 quiver tips, all made from carbon. Light, Medium, Heavy.

Mini extension (30 cm) to convert the rod into 1 foot longer.

VARIABLE LENGTH

Code	Length	C. Length	Sections	Actions	C.W.	Guide
152-57-360	3.30 - 3.60	128	3+1+3	M	75	SiC
152-57-390	3.60 - 3.90	138	3+1+3	MH	90	SiC

SELEKTOR XS ACTIVE FEEDER

Power Joint CX-1 CARBON

The Selektor family include rods that are perfect with feeders up to 130 g. The blank has been built in Super High Modulus Cx-1 Carbon and has a progressive action distributing the load along the whole length. The rod is so really well balanced and powerful enough to cast a mile with method or open end feeder. The equipment includes SiC guides, that can be used in combination with braided lines, double legged in the lower two sections, a natural cork and EVA handle and 3 tips. All the tips, light, medium and heavy action, share the same top red colour, while identification can be easily done checking the wrapping colour of the last guide.

SPECIFICATIONS:



Three tips complete the equipment, with three different actions but with the same high visible red colour and wrapping of different colours for quick identification.



The spiral wrapping reinforces both joints and provides grip to help dismantling rod's sections.

Code	Length	C. Length	Sections	Actions	C.W.	Guide
152-53-360	12' - 3.60	126	3+3	H	110	SiC
152-53-390	13' - 3.90	135	3+3	H	130	SiC
152-53-420	14' - 4.20	146	3+3	H	130	SiC



SELEKTOR PW FEEDER



Power. Control and Precision. these are the qualities requested for a quality feeder rod. Selektor PW Feeder has been designed with top quality, tapered blanks and equipped with 3 carbon tip for a perfect balance. This series is made of 5 models to cover all the needs of medium and heavy fishing. The 3 tips have different sensitivity grade. Cork with EVA inserts handle, ergonomic reel seat and SiC guides.

Code	Length	C. Length	Sections	Actions	C.W.	Guide
152-50-360	3.60	126	3+3	100	MH	SiC
152-50-365	3.60	126	3+3	120	H	SiC
152-50-390	3.90	137	3+3	140	H	SiC
152-50-420	4.20	146	3+3	140	H	SiC

SELEKTOR PELLET FEEDER



This new rod is for sure amongst the top rods in the pellet and method feeder rods market. Built in Super High Moduus Carbon Durawall for the best casting action. Both models have been designed for fighting big fish as carp or barbel. This rods are equipped with 2 tips with different sensitivity, cork with EVA inserts handle, ergonomic reel seat and SiC guides.

Code	Length	C. Length	Sections	Actions	Guide
152-51-360	3.60	126	3+2	MH	SiC
152-51-390	3.90	137	3+2	H	SiC



SYNTIUM PELLET FEEDER



The equipment includes braided friendly SiC guides double legs.

The Syntium family offers two models, dedicated to the more recent branch of feeder fishing, the pellet feeder in open waters and carp fisheries. A 12' medium heavy model for slow flowing rivers and lakes, and a 13' heavy model, dedicated to anglers that are looking for strong emotions with big fish. The Syntium Pellet Feeder are really enjoyable for their power and fast action and are equipped with 2 carbon tips of different sensitivity. The blank is made of Super High

Modulus Durawall Carbon, SiC guides and combines cork and EVA handle.



Syntium Pellet Feeder rods are supplied with two interchangeable tips.

Code	Length	C. Length	Sections	Actions	Guide
152-97-360	3.60	126	3+2	MH	SiC
152-97-390	3.90	137	3+2	H	SiC



AIRTEK SPECIALIST

MICRO PELLET FEEDER



Here how it appears the Micro Pellet Feeder as soon as it lands on the bottom. The pellets start to come out and the bait is already uncovered.



After a short time the pellets start to come out in a sort of small cascade, taking the bait with them. The bait is always perfectly presented.



The Micro Pellet Feeder can be used as well in combination with ground bait instead of pellets. The final result will be the same.

SPECIFICATIONS:



The rod is supplied with 3 interchangeable carbon quiver tips: Light, Medium, Heavy action.



The spiral wrapping reinforces both joints.



The equipment includes braided friendly SIC guides double legs.



Marco Busani



MICRO PELLET FEEDER SET

It is designed to hold micro pellets or groundbaits securely on the cast and with the addition of a matching quick releasing mould with every pack.



AIRTEK SPECIALIST

FLATBED METHOD FEEDER & FLEXY MOULD

Available in the Inline or Elasticated version. The Inline is equipped with a swivel for self strike rigging or for sliding rigging, used in combination with a Fast Change Bead. The Elasticated version allows you to use much thinner hook lengths. For both the versions the flat bed grants a strong grip on the bottom, while the peculiar ribbed design keeps the groundbait right in position.

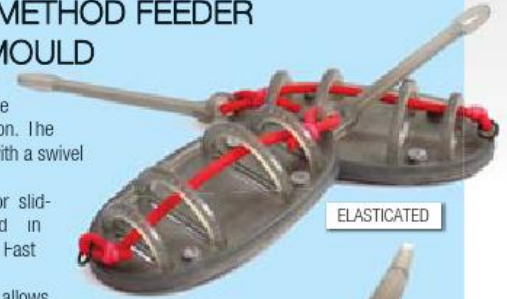

ELASTICATED



INLINE



FLEXY MOULD

This Method feeder is part of a complete program and perform at its best in combinations with the Method Feeder flexy Mould.



Put some pre-damped ground bait into the mould and position the hook with the bait in the centre.



Fill the mould with the rest of the ground bait, taking care to cover the hook with the bait.



Carefully position the Method Feeder in centre of the mould and press firmly.



Press the bottom part of the mould to come out the Method feeder with the perfectly shaped ground bait.



When the feeder will lay on the bottom the bait will be positioned over the ground bait, that will start its attractive action.



When the ground bait will dissolve it will cover the whole feeder, while the bait will be ready to be swallowed by the fish.

Find out more on page 304



Raffaele Mapelli, Maurizio Biolcati

Engineering — SYGNUM — BARBEL — 360

SYGNUM XS BARBEL

This rod, designed for a demanding, growing market, is a perfect rod for barbel fishing in all European waters. Supplied with 1.75 and 2.25lb tip sections, it adapts to different fishing situations. The special High Modulus Carbon used for every section grants both superior stiffness and lightness, and a beautiful look. Progressive action gives a reserve of power to make it suitable even for very large prey. Equipped with Super S-SiC Light Frame guides, the latest design reel seat and natural cork handle.

~~Power Joint~~ S.H.M.R. CARBON



High Modulus Carbon, SiC guides double legs.

Code	Length	C. Length	Sept.	Actions	Guide
151-44-360	3.60	185	2	1.75lbs	SiC

QOSMIO FEEDER

4000 0.200mm/390m 0.250mm/250m 0.30mm/175m

6000 0.200mm/405m 0.300mm/315m 0.400mm/175m

- GRAPHITE BODY
- SUPER LIGHT ALU
- 5.2:1 GEAR RATIO
- 5+1 BB SYSTEM



- Micro-adjusting Front Drag With Oversized Washers
- CNC Machine Cut Aluminum Handle
- Soft Rubber Ergonomic Handle Knob

Find out more on page 167

ERION XT SPECIMEN TWIN TIP



This Powerful rods has been designed for fishing big-sized fish without difficulty in either retrieval or landing. It is a perfect rod for barbell fishing in all European waters. The ERION TWIN TIP is not only a powerful rod but a Specimen rod too. This 12' rod is entirely built in Super High Modulus Durawall Carbon for both superior stiffness and lightness. The progressive action still leave a reserve of power to make it suitable even for very large prey. It comes with two tips 1.75 lb and 2.25 lb to satisfy all casting conditions and for fighting with different fish size. as often comes when fishing for carp, barbel or tench.



SiC guides double legs. The rod comes with two tips 1,75 lb and 2,25 lb.



Code	Length	C. Length	Sections	Actions	Guide
152-68-360	3.60	126	3+2	1.75-2.25 lbs	SiC

ERION XS POWER FEEDER



Special rod designed for barbel fishing. Barbel is one of the most powerful and widespread species in Europe and that's why so many anglers are focused on this fish. What the anglers ask is a super strong and reliable rod that is well balanced and not heavy. The Erion XS is exactly what they ask! The family includes three 3.90 models and this length is sufficient to keep your line out of the stream and avoiding your feeder to drift on the bottom. The Super High Modulus CX-1 Carbon blanks are strong but progressive.

allowing to fight over 4 kilos big barbels with great amusement. The rod is finished with ergonomic cork and EVA handle. DPS reel seat able to host big pit reels and 3 tips. 1 solid glass and 2 solid carbon.



Rods equipped with 3 tips, 1 fiberglass and 2 carbon.

Code	Length	C. Length	Sections	Actions	C.W.	Guide
152-67-390	3.90	138	3+3	H	150	S-SiC
152-67-393	3.90	138	3+3	HH	180	S-SiC
152-67-395	3.90	138	3+3	XH	230	S-SiC

NEW HISASHI FEEDER HOOKS

P1039 MATCH A classic hook for modern feeder fishing, offering a nice balance between strength and lightness. The out-turned eye helps knotless knot to be used to form hair rigs and present sweetcorn, pellets and mini boilies. The fantastic beak point is designed with a fine top edge in order to provide the first prick when the fish bolts and is strong enough to hold firmly during the fight with big fish.

P1003 POWER Nowadays, the gap between heavy feeder and carp fishing is narrow as never before, specially thanks to method fishing and thanks to the wide offer of dedicated baits such as pellets and mini boilies. This means that hooks are subject to higher pressure than in the past, so Trabucco team decided to also develop special hooks like this. Every detail has been carefully studied: from wire thickness to turned eye, from super sharp beak point to nice bronzed finish, a must for this sort of hooks.



Find out more on page 232



PRECISION

THE PRECISION PERFORMANCE

We built the Precision series to offer a complete and very differentiated assortment of feeder rods, with performance similar to the top rods on the market, at a very reasonable price. Then we worked hard to design at least one rod for each technique or fishing situation and finally we took care to finish each model with great accuracy, using cork, SiC guides and a special non slip handle.

PRECISION XT PRO PICKER

A really enjoyable feeder rod that we suggest for short or medium fishing of carp, bream or chub. The light and reliable blank is made of Super High Resistance Carbon. This rod is equipped with SiC guides, so you can use any braided line without any problem, and a comfortable natural cork with EVA inserts handle.

Code	Length	C. Length	Sections	Actions	C.W.	Guide
152-40-270	2.70	142	2+2	M	35	SiC

Precision XT Pro Picker are equipped with 2 tips, each of them very well calibrated for casting heavy feeders.



PRECISION XT PRO BOMB

If you are searching for a reliable and enjoyable rod for fisheries, or small and medium ponds, stop here and take advantage of the performance offered by the Precision Pro Bomb. This 3 meters rod will impress you with its incredible ability and elegance to stop the big fish. The blank bends progressively to fatigue the fish little by little but not tiring the angler's arm. The rods displays 3 tips, 2 in fibreglass and one in solid carbon. The whole rod is equipped with braided lines friendly SiC guides and natural cork/EVA handle.

Precision XT Pro are equipped with 3 tips, 2 fibreglass and one solid carbon.

Code	Length	C. Length	Sections	Actions	C.W.	Guide
152-40-300	3.00	105	3+3	M	70	SiC

PRECISION XT PRO QUIVER



SiC guides double legs.

We designed this model with a progressive Super High Modulus Radial Carbon and we think it is just perfect for small to medium feeders. It can be used at its best in still water for fishes like chub and roach. It has been equipped with three tips, two in fibreglass and one in solid carbon. It also features integrated reel seat, natural cork with EVA inserts handle and SiC guides.

Code	Length	C. Length	Sections	Actions	C.W.	Guide
152-40-330	3.30	105	3+3	M	70	SiC





CASTFORCE FEEDER

5000 0.300mm/180m 0.350mm/130m 0.400mm/100m

Model specially designed for feeder fishing in rivers and large bodies of water. It is a light weight graphite body reel equipped with a long cast machine cut aluminium spool

- New design oversized spool
- Line Guard Protector
- Ergonomic handle with T-Rubber Knob



Find out more on page 166

PRECISION XT PRO FEEDER



S.H.M.R. CARBON

This series is made of progressive action blanks still having a very good power reserve in the butt section. Very sensitive but powerful and reliable: these three qualities make these rods very good for medium-heavy feeders for fishing in big lakes, rivers, fast flowing canals and even salt water, where they are commonly used in the Mediterranean to fish the distrustful gilt-head bream. Such rods cannot be built if not using the best materials such as the Super High Modulus Radial Carbon. They are equipped with SiC guides and natural cork and EVA handle.

Code	Length	C. Length	Sections	Actions	C.W.	Guide
152-40-360	3.60	125	3+3	MH	90	SiC
152-40-365	3.60	125	3+3	H	110	SiC
152-40-390	3.90	137	3+3	MH	90	SiC
152-40-395	3.90	137	3+3	H	110	SiC



PRECISION XT CARP FEEDER



If you consider feeder fishing to catch many big carps your technique, then the Precision carp Feeder is definitely your rod and you cannot stay without it! It has been specifically designed to fish carpodromo, carp fisheries and big rivers, where carp are not only big but really great fighters. The Super High Resistance Carbon allows a casting power up to 120 g and a total reliability to face the big ones. The Precision Carp Feeder features two fibreglass tips and double leg SiC guides to magnify its fighting qualities. Natural cork handle.

Code	Length	C. Length	Sections	Actions	C.W.	Guide
152-41-360	3.60	126	3+2	H	120	SiC
152-41-390	3.90	134	3+2	H	120	SiC

PRECISION XT RIVER FEEDER



This new series can be defined "allround for extreme situations". They are perfectly calibrated for fishing in fast flowing rivers and canals. The progressive power action is maximized by the great power reserve in the butt section, being able to stop the big fish who is trying to escape in the middle of the stream. It is the perfect rod for barbell fishing with up to 150g feeders and still you can use in more quite situations. In Southern Europe they are used to fish from piers and beaches to catch gilt-head bream. The Precision River Feeder has two tips, one in fibreglass and one in solid carbon, to match different situations. The equipment is completed by SiC guides and natural cork handle.

Code	Length	C. Length	Sections	Actions	C.W.	Guide
152-42-360	3.60	126	3+2	HH	150	SiC
152-42-390	3.90	134	3+2	HH	150	SiC



NEW PRECISION XT SW FEEDER



Built with High Resistance carbon to bear any sort of stress, these rods can be heavily loaded to shoot heavy rigs at long distance. The big cage feeders can fly out where barbel, carp and catfish are waiting for food, while the rod is equally at home at sea side with closed end feeder packed with maggots to tempt the Mediterranean sea bream. The reliable overcap joints are further reinforced by crossed carbon bands without affecting the perfection of action curve. In order to suit the demand about naked handles, the rod shows separated rubber and EVA grips, with just blank in between. All the components have been carefully selected, with good quality double leg guides and sturdy screw reel seat to also accept big size reels. Three quiver tips are included: two nylon (Light, Medium) and one carbon (Heavy).

Code	Length	C. Length	Sections	Actions	C.W.	Guide
152-46-360	3.60	125	3+2	MH	90	SiC
152-46-390	3.90	135	3+2	H	110	SiC



Screw reel seat made from steel and rubber. Naked handle with EVA butt grip. Two quiver tips: one fiberglass (Medium) and one carbon (Heavy).



PRECISION XT FEEDER PLUS



S.H.M.R. CARBON

Powerful but balanced progressive rod made of Super High Modulus Carbon. We want to highlight the excellent casting performance of this new model: it really casts further and more accurately. We can define this rod a value for money rod. but you should not think this is a second category rod. Actually all the components we used to equip it is as good as those we use for more expensive rods: SiC guides, extra smooth for braided use too. EVA ergonomic handle and double super sensitive fibreglass tips.

SPECIFICATIONS:



The rod is supplied with 2 interchangeable quiver tips: Medium, Heavy action.



Double leg SiC guides.



All the rods are equipped with Hookholder.

Code	Length	C. Length	Sections	Actions	C.W.	Guide
152-43-360	3.60	126	3+2	MH	90	SiC
152-43-365	3.90	126	3+2	H	120	SiC



NEW PRECISION XT COMBI TIP



S.H.M.R. CARBON

A modern match & feeder rod which allows the pleasure anglers to switch from feeder to waggler in case fish move up in the water to look for warmer temperature. It happens so often in the commercial lakes, specially during summer season and in such cases a single rod like this can brilliantly do the job. This is possible thanks to the twin top section supplied with new Precision XT: one is the classic feeder top, carrying two different quiver tips (both fibreglass made 1 oz Medium and 2 oz. Heavy) and the other is a tubular type, powerful match top able to deal with waggler and pellet waggler up to 25 grams weight. The rod handle is proving how much Trabucco development team pays attention to functional details. An EVA fore grip for comfort and easy cleaning of reel seat area, then natural cork with hot printed logo, then a rubber butt grip ending with soft, rounded cap so useful during those long fights with powerful carp.



Screw reel seat made from steel and rubber. Natural cork handle with special EVA butt grip. Feeder top section + 2 quiver tip; tubular Match top section (250 gr).

Code	Length	C. Length	Sections	Actions	C.W.	Guide
152-44-360	3.60	125	3+3	MH	90	SiC



LAKE TROUT

Why spend more when you get a chance to find a higher quality rod at a lower price? This is a question that many anglers should ask, especially in lake trout fishing. Trabucco this year offers a great opportunity to all enthusiasts anglers of this unique opportunity: the ability to buy advanced technology and quality products at a lower market price. Before buying any trout rods please compare it to a Trabucco one, close your eyes and try to feel the differences ... At that point you will notice that the only difference is the price because our is the best one in the market. Use your brain, if you know fishing you choose Trabucco.



NEW DREAM TEAM XPS LAKE TROUT

SS SUPER SLIM BLANK SENSI TOUCH L CROSSED REINFORCED CX2 CARBON NANO-TEK



Top of the range series with Super Slim design which gives a nice handling to all rods, including the powerful 44LD. This specification comes from lake trout's competition world, as well as the spliced top section, which is vital to detect fish bites, specially when trout are particularly shy. The wonderful lightness and the outstanding strength of Dream Team XPS rods is due to CX2 carbon construction, in which the bonding agent is a nano-tech resin that can be evenly dispersed between layers, even in limited quantity. Guide's configuration is well designed, with "Y" frame guides to avoid vibrations and small diameters to get a nice flow of the line; wrappings show hi-class quality, and include coloured yarn to match action colour code bands visible on butt section of each rod. The series is wide enough to equip the demanding angler and let him face all weather conditions, in the small lakes as well as the big and deep ones located up north.



SPECIFICATIONS:

Code	Length	C. Length	Weight	Sect.	Action	C.W.	Guide
124-28-100	3.90	118	110	7	UL	1-3	SiC
124-28-200	3.90	118	130	7	L	2-5	SiC
124-28-300	3.90	118	140	7	LL	3-8	SiC
124-28-400	4.00	128	160	7	ML	4-10	SiC
124-28-500	4.20	128	170	5	M	8-15	SiC
124-28-600	4.30	132	190	5	MH	12-20	SiC
124-28-700	4.40	132	200	5	MHS	15-30	SiC



Plate reel seat, finely wrapped. Ultralight butt cap directly screwed into the carbon wall.

ASTORE PRO LAKE TROUT



Lightweight, strong and balanced: these are the characteristics for a tremarella/bombard rod. And the more you can get in these three categories, the more these rods are appreciated among the competitors. So to obtain such a brilliant result we decided to design each action independently from the others, trying to optimize the power curve removing as much sliding guides as possible. The result has been achieved by opting for seven sections blanks for actions from 1 to 4 and five sections for the actions 5 to 7. The carbon used could not be other than super high modulus CX-2, the only one that has the characteristics of perfect transmission of vibrations and yet so strong and lightweight. Also, to further increase the sensitivity of the rod, the reel-seat has been integrated in the butt section. SiC guides allow the safe use of smaller lines without the risk of



Super Slim blank made from CX2 Nano-Tek carbon. The rods are equipped with Hookholder. Medium leg guides with "Y" shaped frame (SiC ring).



Action colour coded wrappings.



SS SUPER SLIM BLANK SENSITOUCH CX2 CARBON NANO-TEK

overheat caused by friction. Every action is characterized by a band of different color on butt section.

Code	Length	C. Length	Weight	Sect.	Action	C.W.	Guide
124-17-100	4.10	128	105	7	UL	1-4	SiC
124-17-200	4.20	135	152	7	L	2-6	SiC
124-17-300	4.20	135	162	7	LL	3-8	SiC
124-17-400	4.20	135	164	7	ML	4-10	SiC
124-17-500	4.30	138	172	7	M	6-12	SiC
124-17-600	4.50	145	220	7	MH	8-15	SiC
124-17-700	4.60	150	232	7	MHS	12-20	SiC



NEW ATTRACTIVE PRO LAKE TROUT



An innovative solution applied to handle area gives these rods a real plus in term of comfort. It's the rubber shrink tube which dresses the bottom half of butt section, also providing easy cleaning and protection from scratch due to rod rack tubes. The fast tapered blanks are quite firm, with little or no oscillation after the cast, a common problem which can visibly reduce the distances. The great precision of action curves is perfectly followed by the mainline, thanks to the sliding guides carefully wrapped on to carbon pipes. Attractive Pro series is made of six actions, well spaced each other, and offer the match angler the chance to buy twin rods without spending a fortune, because prices have been targeted with great care since the very start of the project.

Code	Length	C. Length	Weight	Sect.	Action	C.W.	Guide
124-29-100	3.90	110	170	7	UL	1-4	SIC
124-29-200	3.90	115	172	7	L	2-6	SIC
124-29-300	3.90	110	174	7	LL	3-8	SIC
124-29-400	4.00	110	185	7	ML	4-12	SIC
124-29-500	4.10	125	205	7	M	8-15	SIC
124-29-600	4.40	125	237	6	MH	10-20	SIC



NEW ACTIVA LAKE TROUT

This new series follows former Syntium, but offers some new elements which are destined to draw the attention of more and more pleasure anglers. First of all, let's introduce the new combination of length and power – called 430MH – which can cast 25-30 grams bombardas at long range, in order to reach trout shoals looking for fresh temperatures in the deep lakes during hot summer. The rod is fitted with solid carbon tip to detect even the lightest bites. The new 40ML comes from old 3,90 rod, whose length has been brought to 4 metres to allow the use of longer hooklinks,

Code	Length	C. Length	Weight	Sect.	Action	C.W.	Guide
124-30-100	3.90	128	150	7	L	2-8	SIC
124-30-200	4.00	128	160	7	ML	4-15	SIC
124-30-300	4.20	128	190	7	M	10-20	SIC
124-30-400	4.20	128	210	7	MH	15-30	SIC



not a fashion issue but a real need with nowadays difficult trout. No change for the 7 section's configuration, because it's the only way to avoid the addition of sliding guides on sections below the top.

NEW ERION X-PWR LAKE TROUT

This series is particularly indicated for those small lakes which are so common all over Europe, where the rod's power is not destined to cast at range, but it's useful to lift trout from water at speedy rate. In fact, all five rods in the series have been designed around same length - namely 4 metres – and stand out for their compact closed length and slim handle diameters. The solid carbon tip, responsible of the neat bite indication, is fitted on second section via telescopic joint, a simple but effective solution at the same time. On top of each section, there is a crossed reinforcement made from an orthogonal carbon band; it is there to protect joints from heavy loads

Code	Length	C. Length	Weight	Sect.	Action	C.W.	Guide
124-31-100	4.00	85	150	8	L	2-6	S-SIC
124-31-200	4.00	85	160	8	ML	4-8	S-SIC
124-31-300	4.00	86	170	8	M	6-12	S-SIC
124-31-400	4.00	87	190	8	MH	10-20	S-SIC
124-31-500	4.00	87	200	8	H	15-30	S-SIC



which could cause breakages. Such solution makes Erion able to bear the inevitable stress due to newcomer's rawness





NEW REVENTON MASTER LAKE



The cheapest of Trabucco lake trout rods can surprise more than a few expert anglers for the amount of technical specifications which have been put in this project. Firstly, the remarkable taper gives the rod a perfect balance and allows the newcomer to experience good casts. Secondly, as soon as the retrieve starts, any message coming from the hookbait is clearly sent to the user, even in case of shy bites. Thirdly, the production has been run under strict quality control, so that all telescopic joints are fitting perfectly, with great advantage in term of sensitivity and strength. The medium leg guides have been carefully chosen in order to avoid any excess of weight and leave the blank maximum freedom.

Code	Length	C. Length	Weight	Sect.	Action	C.W.	Guide
124-32-100	3.90	130	168	5	L	2-6	S-SiC
124-32-200	3.90	130	172	5	ML	4-10	S-SiC
124-32-300	4.10	130	175	5	M	6-15	S-SiC
124-32-400	4.20	130	180	5	MH	10-20	S-SiC



Medium leg guides with SiC ring. Plate reel seat, wrapped. Aluminium butt cap.



ASTORE TX BOLO

Adjustable rod series designed for river trout fishing, built in Super High Modulus Radial Carbon Technology in 4-5-6 and 7m lengths. Extremely light but robust and reliable, this rod is also recommended for other fishing techniques requiring a very stiff and strong rod, such as salt water fishing and bolognese with heavy floats. Equipped with Super S-Sic guides and amortized reel seat. A unique fishing rod, easy to use. It will be appreciated mainly by expert anglers.



Code	Length	C. Length	Weight	Sect.	Guide
124-45-500	4.00 - 5.00	147	260	5	Sic
124-45-600	4.00 - 5.00 - 6.00	150	345	6	Sic



MULTI LENGTH SYSTEM SENSi TOUCH CX2 CARBON NANO-TEK

NEW VANADIA XT-MATCH

Rods which show an impressive Super Slim butt, considering the tremendous power it can deliver, with a slightly upper reel seat which is there to help you push as much as you like. The body of these rods is engineered to be heavily loaded, thus boost heavy bombardas to the horizon. The job is done by CX-1 Micro Pitch carbon, whose structure is so tight that the blank's answer is strong and neat, without oscillations. The blank is further powered and protected by a cross winding carbon yarn, which is purposely missing on top section to generate a perfect action curve. Guides are short leg HD model, able to quickly disperse heat caused by the endless line flow, an essential part of lake trout fishing.

Code	Length	C. Length	Weight	Sect.	C.W.	Guide
150-34-450	4.50	130	202	7	10-60	Sic
150-34-455	4.50	130	208	7	20-80	Sic



Blanks made from Micro Pitch Carbon CX-1. Cross Winding carbon reinforcement.

Medium leg HD guides (quick heat dissipation).

CV CROSS WINDING SENSi TOUCH SS SUPER SLIM BLANK CX1 MICRO PITCH

SLURP & YUMMY BAIT

Honey worm, earthworm and some other larvae are the most common natural bait used in lake trout fishing. But they bring at least three disadvantages. First of all, they suffer high temperatures, and day after day their efficiency fades sharply. Secondly, they can't resist to trout's crunch, as they tear them. Consequently, they must be replaced after each trout landed, otherwise the bite's rate slows down, and maybe some bites are easily missed. Finally, with natural worms the correct hooking operation can be difficult, and to improve the hook position the angler has no other choice but to replace the bait. All these problems have been successfully solved by Trabucco with his own fantastic Yummy and Slurp artificial bait, which offer endless solutions in term of silhouette, size, texture, taste, colour and scent, up to helping the hookbait's rotation through computer designed shapes.



Find out more on page 328

BLACK HT BOMBARDAS

Developed and engineered by Trabucco team for lake trout competition.

These bombardas are made from EVA, a material which is known for the resistance to shocks and for its elasticity against compression. But there is something more, because the artificial nature of this material offer a consistent buoyancy, due to the even distribution of the air bubbles throughout the volume. Consequently, their behaviour in action is very much stable from one piece to another, and also during its life. In water, they sink according to four different plans and keep an almost horizontal attitude during the retrieve. That's important to ensure that the hookbait travels at regular depth, as well as offering the highest sensitivity. The action displayed in water depends from weight and position of brass stabilizers, which are placed in the heart of the body. The tubular stem is made from high strength plastic and is coloured to allow quick identification of each model.



BLACK HT SUPERFICIE

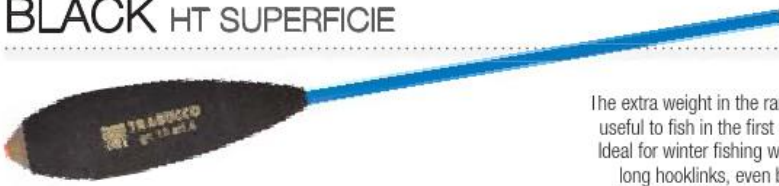

The extra weight in the range of 1-3 grams makes it useful to fish in the first meter below water's edge. Ideal for winter fishing with quick retrieve and extra long hooklinks, even beyond the 2 metres mark.

Code	Weight (g)	Extra Weight
017-00-060	6	1.0
017-00-080	8	1.5
017-00-100	10	1.5
017-00-120	12	2.0
017-00-150	15	2.0
017-00-200	20	2.0
017-00-250	25	3.0

BLACK HT MEZZO FONDO



Its name tells that it works wonder in mid-water with slow retrieve, but its weight pattern enables to also operate at higher speed during autumn and winter. Long hooklinks are recommended.

Code	Weight (g)	Extra Weight
017-01-060	6	1.5
017-01-080	8	2.5
017-01-100	10	3.0
017-01-120	12	3.5
017-01-150	15	3.5
017-01-200	20	4.0
017-01-250	25	4.0

BLACK HT FONDO

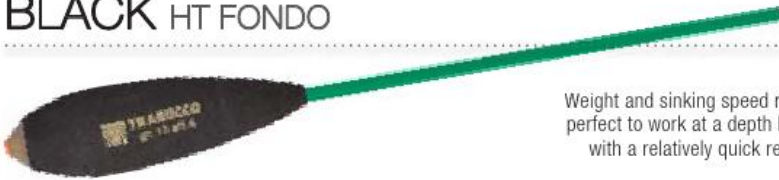

Weight and sinking speed ratio make this bombarda perfect to work at a depth between 3 and 6 metres, with a relatively quick retrieve to attract the most aggressive trout.

Code	Weight (g)	Extra Weight
017-02-060	6	3.0
017-02-080	8	4.0
017-02-100	10	5.0
017-02-120	12	6.0
017-02-150	15	6.0
017-02-200	20	7.0
017-02-250	25	7.0

BLACK HT BUGIARDINO



It's the quickest sinker in the range, and once down it keeps an ideal route at least around 8-10 metres of depth and more. Therefore, summer is the season when it gives the best with aggressive retrieve.

Code	Weight (g)	Extra Weight
017-03-060	6	3.0
017-03-080	8	4.0
017-03-100	10	5.0
017-03-120	12	6.0
017-03-150	15	8.0
017-03-200	20	10.0
017-03-250	25	12.0

BLACK HT BOMBARDAS - Swimming attitude

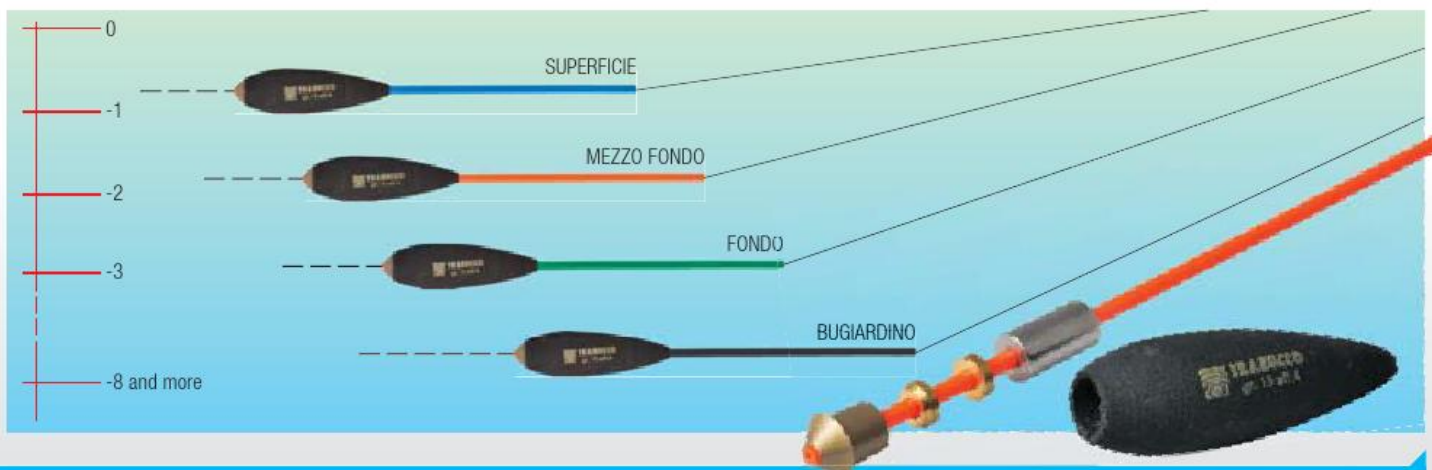

SLIM TUBE

The classic lead sinker, good in most conditions. It sinks slower than the short model. Bag of 5 pieces including rubber tube.



Code	Weight (g)
090-80-020	2.00
090-80-025	2.50
090-80-030	3.00
090-80-035	3.50
090-80-040	4.00
090-80-045	4.50
090-80-050	5.00
090-80-060	6.00

SUPER SLIM TUBE

Ultra thin and long, this lead sinks very slowly, so it's perfect for surface work. Bag of 5 pieces including rubber tube.



Code	Weight (g)
090-81-010	1.00
090-81-015	1.50
090-81-020	2.00
090-81-025	2.50
090-81-030	3.00
090-81-035	3.50
090-81-040	4.00

MICRO SLIM

A micro version of Slim Tub model, developed to create strings useful with wary trout. Bag of 5 pieces including rubber tube.



Code	Weight (g)
090-82-002	0.20
090-82-003	0.30
090-82-004	0.40
090-82-005	0.50
090-82-007	0.70
090-82-010	1.00
090-82-015	1.50

SHORT TUBE

Trout lead sinker with compact body, ideal for speed fishing or to swim close to the bottom. Bag of 5 pieces including rubber tube.



Code	Weight (g)
090-83-020	2.00
090-83-025	2.50
090-83-030	3.00
090-83-035	3.50
090-83-040	4.00
090-83-045	4.50
090-83-050	5.00

MICRO SFERE

Compact shape means higher sinking speed. Developed for medium speed surface work or slow retrieve close to the bottom. Bag of 5 pieces including rubber tube.



Code	Weight (g)
090-84-001	0.10
090-84-002	0.20
090-84-003	0.30
090-84-004	0.40
090-84-005	0.50
090-84-007	0.70
090-84-010	1.00

PLASTIC OLIVE

It is typically used in trout lake fishing to calibrate the float or themselves to "Saltarello". Recommended for clear waters when targeting very suspicious fish.



Code	Weight (g)	Pcs
013-97-002	2.0	5
013-97-003	3.0	5
013-97-004	4.0	5

VETRINI TROUT GHOST

Clear glass tubular sinkers for lake trout fishing at close distance. Available in bags of 3 or 4 pieces depending on size.



Code	Weight (g)	Pcs
013-95-002	2.0	4
013-95-003	3.0	4
013-95-004	4.0	4
013-95-006	6.0	3
013-95-008	8.0	3

VETRINI IRIIDIUM PIOMBATI

Small plastic sinkers. Compared to glass models, these sink slower and allow the angler to search the fish in a very shallow depth, even at short distance.



Code	Weight (g)	Extra Weight
017-70-020	2.0	1.4
017-70-030	3.0	1.7
017-70-040	4.0	1.9
017-70-050	5.0	2.1
017-70-060	6.0	2.3

SWIVELS & RUBBER STOPPERS

In order to get the best from bombardas, lead and glass sinkers, Trabucco range offers some excellent accessories.

The double and triple swivels belonging to Power Swivel assortment are perfect to download the inevitable torsion generated during the retrieve, because the hookbait spins quickly. Beyond the traditional swivels with connected eyes or multiple bodies, the HS Rolling Special is quite interesting because it offers a quick change clip to replace the hooklink instantaneously. We recommend to insert a segment of silicone tube on to the hooklink, before forming the loop. Once the loop has been connected to the swivel's clip, the tube locks everything. Please take care not to cover the clip's mouth with the tube.

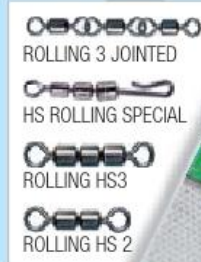

The knot connecting swivel to mainline is subject to hard stress due to bombardas weight, so it's highly recommended to protect it with an Oval Rubber Stopper from Competition range, available in four sizes.



Find out more on page 324



BOMBARDA IRIDIUM ZERO GRAVITY



White colour Bombarda, made of unbreakable plastic material. It is floating and allow to fish on surface, both with a retrieve or still action. This particular Bombarda can be used also in those competition in which the surface fishing is not allowed.

Code	Weight (g)	Extra Wt.
017-45-040	4	0
017-45-060	6	0
017-45-080	8	0
017-45-100	10	0
017-45-150	15	0
017-45-200	20	0
017-45-300	30	0

BOMBARDA IRIDIUM PRO LIGHT



Satinated colour Bombarda, made of plastic material. Due the use of one only construction material the sinking capacity is guaranteed. The sinking grades are very small, in order to allow the angler to search trout on surface or mid depth.

Code	Weight (g)	Extra Wt.
017-65-040	4	0.8
017-65-060	6	1.2
017-65-080	8	1.6
017-65-100	10	2.0
017-65-150	15	3.0
017-65-200	20	4.0

AQUA BOMB



Water filled Bombarda, entirely made by transparent polycarbonate. It is possible to obtain a casting and floating weight by filling more or less the Aquabomb with water. Suggested for lake trout fishing and as well in sea, as a classic "buldo".

Code	Weight (g)
015-60-050	5
015-60-080	8
015-60-100	10

LONG CAST SPHIROLETTE



Long Cast Sphirolette represent the good solution to cast at long range any light lure or bait, as it often happens in lake trout fishing. Can also find good use at sea with grubs or to cast lightweight baits.

Code	Weight (g)
013-96-010	10
013-96-015	15
013-96-020	20

T-FORCE XPS TROUT



This transparent monofilament is dedicated to all the people who loves fishing for trout in lakes or fisheries. Its color makes it perfect for use especially in crystal clear water. The special manufacturing procedure used makes it extremely resistant to twisting and the extremely smooth surface allows to reach incredible casting distance even using lightweight lures or rigs. Available in five different diameters on 150 meters spool.

Find out more on page 199

PENNA TROTA

Straight peacock designed for trout fishing. Both ends are fluo painted to be reversed according to light conditions.



Code	Weight (g)
001-20-095	2.00, 3.00, 4.00, 5.00, 6.00

STRIKE IN LINE

Short dibber float with fluo top and line running through the body. Designed for shallow and running waters, it's just awesome for trout fishing in small rivers.



Code	Stem	Antenna	Weight (g)
001-20-100	Carbonio	Fiberglass	1.00, 2.00, 3.00, 4.00, 5.00

ZOOM IN LINE

Elongated dibber float, with fluo top, line running through the body and bushed top. Designed for lake trout, it can be well employed also for other species.



Code	Stem	Antenna	Weight (g)
001-20-090	Carbonio	Fiberglass	2.00, 3.00, 4.00, 5.00, 6.00

RIVER TROUT

When you fish trouts in rivers you often need a good strength and very good fishing tackles. We can provide you the correct adjustable rods, just perfect for this technique: light, stiff and powerful. In our catalogue you will find rods for super specialists, competition anglers and passionate anglers, that need short sections rods.



DREAM TEAM XPS RIVER

The top rod of our range is now the Dream Team Trabucco XPS River, a science fiction 10 meters of unsurpassed performance. Its excellence comes from the wise use of the best super high modulus carbon Nano-Tek CX-2 and from the specific design of each section. A judicious lay of the carbon fibers, both linear and radial, that varies in each element in order to have always and in any case the maximum performance. The encumbrance of the blank has been reduced to the minimum in order to allow easy transport and an easier handling, without thereby affect the fishing action, which turns out to be very strong and stiff and therefore makes possible to detect the most shy and wary bites. The strike is always ready, rapid and inexorable, a sort of shot that we guarantee to surprise the trout and firmly pierce it mouth with the hook. The blocks are made using the shrink tube, extremely versatile, reliable and lightweight. Single legged SiC guides allows you to use thinner monofilaments without harming it with the heat of friction, avoiding to deteriorate their technical qualities and prolonging their life.



Maurizio Biolcati



Code	Length	C. Length	Weight	Sections	Guide
124-49-100	10.00	160	499	8	SiC



ASTORE TX RIVER TROUT

Fishing for trout in rivers requires rods with very high specs, if only to attend the rigidity and lightness required. The Astore TX Trout River is built in CX-2 Nano-Tek Carbon, a super high modulus carbon that is unrivalled in reliability, rigidity, break resistance and lightness. The lower sections, those of greater diameter, have been designed to be just slightly tapered to allow the use of the shrink tube for the realization of the adjustable blocks, saving precious grams on the total weight which remains therefore not only restrained but also exceptionally well-arranged and thus balanced. Single foot SiC guides provide an excellent smoothness to the monofilament in every condition.



Code	Length	C. Length	Weight	Sections	Guide
124-43-700	7.00	140	308	7	SiC
124-43-800	8.00	146	403	8	SiC



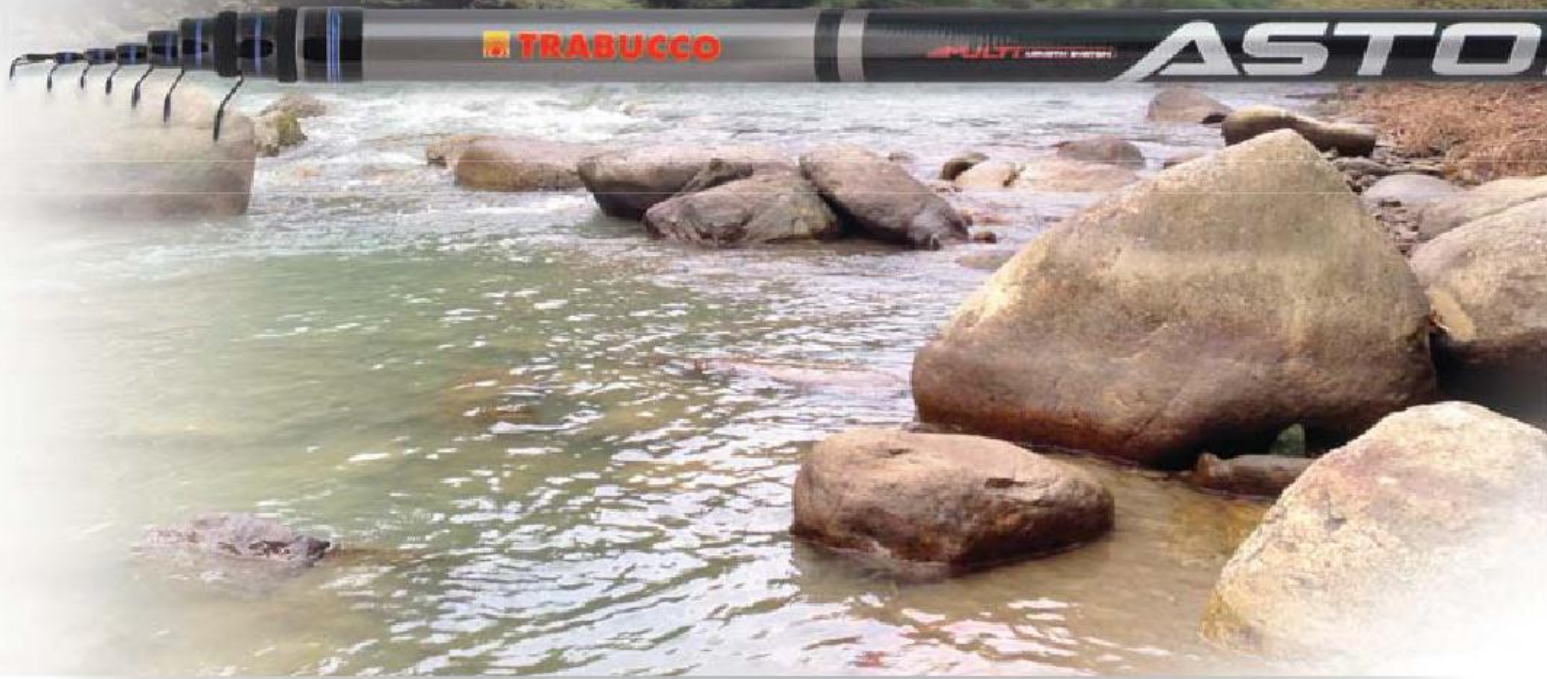

ATTRACTIVE TRL RIVER TROUT



Maximum reactivity of the blank with a particular attention to the control of the fish. This was our target, but not only: we wanted a stiff rod (very stiff), light and with a slim blank. Thanks to the CX-1 High Modulus carbon the result is exciting, the rod is very light and very well balanced, but what surprises most is the stiffness ... it seems only the tip is bending. We really like this rod, ask your dealer to let you try and then compare it to any other rod in this price range, you will see that the value for money is unbeatable.

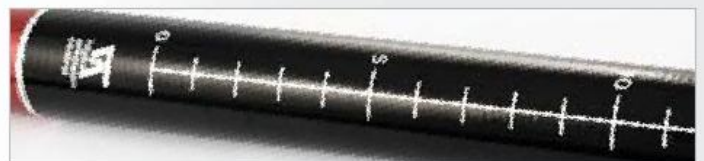

Code	Length	C. Length	Weight	Sections	Guide
124-44-500	5.00	135	285	5	SiC
124-44-600	6.00	135	405	6	SiC

SYNTIUM TRL RIVER



Practical and effective short butt section adjustable rod, stiff and powerful. Reliable in any situation, the blank is made from super high modulus radial carbon, light-weight but extremely strong and durable. A crossed carbon yarn has been added as reinforcement in the most stressed parts to enhance its stiffness and to allow to directly lift the prey. Short leg S-SiC guides complete the features of this interesting rod.

Code	Length	C. Length	Weight	Sections	Guide
124-79-500	5.00	125	206	5	S-SiC
124-79-600	6.00	137	440	6	S-SiC

ASTORE TX BOLO

MULTI LENGTH SYSTEM

SENSI TOUCH

CX2 CARBON NANO-TEK

RE TX BOLO 600S

A very stiff bolognese rod, but still slim, light weighted and well balanced. Designed to strike the prey and tearing it off the water quickly, without disturbing the fishing area. The tip is extremely sensitive and fast and can stop the fish run anticipating its reactions. The ability to adjust the length according to the fishing needs is a huge tactical advantage, but what impresses most is how this rod rules the fish. A fishing rod easy to use that will be appreciated mainly by expert anglers.



Code	Length	C. Length	Weight	Sections	Guide
124-45-500	4.00 - 5.00	145	187	5	SiC
124-45-600	4.00 - 5.00 - 6.00	150	280	6	SiC
124-45-700	4.00 - 5.00 - 6.00 - 7.00	150	340	7	SiC

ERION XS MINI BOLO

SENSI TOUCH CX-1 CARBON



Let's face it: a handy and compact rod, you can leave in the car and that is not only easy to use but first of all reliable, it is a rod that is interesting for everybody. So this is not a rod for specialists but a rod which finds its use in the stream as in the pond, river or at sea. The high resistance carbon is a guarantee of total reliability, forgiving the mistakes of beginners, but also guarantees lightness and precision. The ringing S-SiC quickly disperses the heat, and allows the safe use of even very thin monofilaments.

Code	Length	C. Length	Weight	Sections	Guide
124-83-320	3.20	63	120	7	SiC
124-83-360	3.60	64	150	8	SiC
124-83-400	4.00	66	190	9	SiC
124-84-340	3.40	65	160	7	SiC
124-84-380	3.80	66	185	8	SiC

ANTRAX BLS STREAM

SENSI TOUCH

CROSSED REINFORCED

High precision control



Compact and short elements Bolognese rod. It can be used in a number of situations thanks to their easy handling and reliability, really at the top. The high resistance carbon fibers make the blank not only lightweight but also strong enough to fight whatever fish will bite at your bait.



Code	Length	C. Length	Weight	Sections	Guide
124-80-380	3.80	104	175	5	S-SiC
124-80-450	4.50	108	230	6	S-SiC

ORBITRON FX

SENSI TOUCH

CROSSED REINFORCED

High precision control



These rods are made using a new procedure which allows the combination of H.R. Carbon and Powerfibre. Easy to transport, these rods can be used for trout fishing in reservoirs and streams, even with heavy rigs. The Orbitron FX is really versatile and if necessary can be used as Bolognese when fishing for carp. All the rods are equipped with S-SiC guides and premium quality reel seat.



Code	Length	C. Length	Weight	Sections	Guide
124-74-300	3.00	72	145	5	S-SiC
124-74-350	3.50	74	195	6	S-SiC
124-74-400	4.00	77	245	7	S-SiC

SPECIMEN

Big fish never allow you any mistake. So you cannot accept any compromise when specimen hunting. We have rods designed to avoid that giant catfish and powerful sturgeons will find their way and escape in the deep. We know all these situations very well and this is why our specimen rods are the best...cause we are just like you: we really enjoy it only when everything is under control!



MAXXIS MONSTER

~~Power Joint~~ **CX-1**
CARBON



Armando Tiberi



We spent many hours on the river to test our new MAXXIS MONSTER fighting with huge catfish. Simply perfect to be used from the boat and for lure fishing from the shore, these rods revealed enormous power and progressive action which helps to rule even the toughest fish in extreme conditions. The blanks are built using full CX-1 Carbon and are equipped with double leg SIC guides. This rod is perfect to be used with braided lines and features the virtually unbreakable Magic Stick Tip. Ergonomic handle wrapped in premium quality EVA delivers the maximum comfort and grip in any situations.

Code	Length	C. Length	Sect.	C.W.	Guide
157-31-210	2.10	108	2	150	SIC
157-31-215	2.10	108	2	300	SIC
157-31-240	2.40	124	2	150	SIC
157-31-245	2.40	124	2	300	SIC
157-31-270	2.70	138	2	150	SIC

Stefano Grassi
Francesco Palli

NEW INDULGENCE SPECIMEN

A new telescopic series, developed to offer the pleasure angler affordable rods with compact closed length, reliable structure and good performances. In other words, everything needed to catch big size fish, packed in a few centimetres. The butt section length couldn't be shorter than it is, because reel seat position is an important specification for this sort of rods, which are destined to cast heavy feeders or simple ledger bomb with paste bait for carp and barbel fishing, both in lakes and fast running rivers. Blanks are made from High Resistance carbon, whose main difference with High Modulus is the ability to bear extreme stress, coming from fast and furious fights but also from hard life on the banks or on the boat. With their metal frame, guides are really unbreakable, while their SiC ring protects line from abrasion and excessive heating.

Code	Length	C.Length	Sect.	Test lbs	Guide
156-30-100	3.60	78	6	3.00	Metal Frame + SiC
156-30-200	3.60	78	6	3.50	Metal Frame + SiC
156-30-300	3.60	78	6	4.00	Metal Frame + SiC

S.H.M.R.
CARBON

Comfortable Rubber handle grip and butt grip. Graphite screw reel seat.



Super strong metal frame guides with SiC ring.



Trabucco logo is finely engraved on aluminium butt cap.

NEW EXCURSION T-SPECIMEN

In spite of relatively slim blank, it has no problems with big barbel, carp, catfish and eels, thanks to the High Resistance carbon construction which has proven to be extremely strong during preliminary field tests. Most anglers across Europe tend to specialize their fishing on just a single species, or like to go fishing in a limited number of venues. Therefore, they accumulate a lot of experience and skills in a relatively short time, getting good catches and good reputation as well. This new Excursion rod is expressly dedicated to them, with nice but effective specifications like tubular top, quality double leg guides and screw reel seat with steel hoods. The closed length of just one metre allows

Code	Length	C.Length	Sections	Test lbs	Guide
156-41-360	3.60	99	5	3.00	SiC

CROSSED
REINFORCED
S.H.M.R.
CARBON

it to be stored in the car boot: always ready to get into action!



Double leg SiC wrapped guides.

CARP FISHING

Target Big Fish! The direct confrontation and catching the fish is the objective pursued by those who practice these fishing techniques. We know this and our wide range of products is made to cover these needs with the proper rods: with the sole purpose of catching a powerful large fish! Considering that there are people who fish in large rivers and people who just fish in commercial fisheries, people who prefers the powerful two-piece, other who prefers three pieces and finally considering telescopic rods fans ... we propose a complete range, from more specialistic rods to the most versatile ones, so we are confident that you will surely find in these pages the rod for you. Certainly you will not find anywhere such a value for money rods.

LEGEND CARP X2

S.H.M.R.
CARBON

Full high resistance carbon rod made in 2 sections. The overall look is dramatic thanks to the first class woven carbon finishing. The progressive action is outstanding for the price, powerful when casting and yet enough soft to manage the carp during the fight. Best components has been used to finish the rod, using double leg SIC guides, ergonomic screw reel seat and EVA handle.



Code	Length	C. Length	Sections	Test lbs	Guide
156-37-360	3.60	188	2	3.00	SIC





Armando Tiberi

LEGEND CARP X3

S.H.M.R.
CARBON

3 sections rod fully built in high resistance carbon with classic action. The blank has a great power reserve, so to make it so similar to a more common 2 pieces carp rod. The 3 pieces construction will help during the transport. It is an easy to use rod, reliable and very enjoyable. It is equipped with double legs SiC guides, screw reel seat and EVA handle.

Code	Length	C. Length	Sections	Test lbs	Guide
156-38-360	3.60	125	3	3.00	SiC

ARMADON

S.H.M.R.
CARBON

Made in HR carbon (high resistance) with Woven Carbon reinforced. Excellent progressive parabolic action for an accurate and powerful casting. Fitted with SiC guides, ergonomic screw reel seat with shock absorbers, handle special anti-slip material that improves grip during casting.

Code	Length	C. Length	Sections	Test lbs	Guide
156-33-360	3.60	188	2	3.00	SiC





Goran Radovic

CYCLONE

S.H.M.R.
CARBON

The CYCLONE CARP is made in H.M. Carbon with woven Carbon on the joint and handle to enhance power and reliability. Progressive action while playing the carp but enough power to achieve long distance casting. SIC guides, non-slip handle and ergonomic reel seat.

Code	Length	C. Length	Sections	Test lbs	Guide
156-31-360	3.60	188	2	3.00	SIC

CYCLONE X3

S.H.M.R.
CARBON

Three pieces carp rod made using H.R. Carbon. Thanks to the new construction procedure this rod will surprise you for the perfect fast-parabolic action. Easy to carry and transport, this rod can be used in many situations. Equipped with first choice EVA handle and double leg SIC guides.



Code	Length	C. Length	Sections	Test lbs	Guide
156-32-360	3.60	125	3	3.00	SIC

THUNDER

S.H.M.R.
CARBON



If you are looking for a good carp rod, made from carbon and at an affordable price, stop here! The Thunder has been entirely made from high resistance carbon and features a classic progressive action, being able to cast well and to manage the retrieve of a big carp with no problems. Equipped with double legs S-SIC guides to allow you to use braided lines.

Code	Length	C. Length	Sections	Test lbs	Guide
156-39-360	3.60	188	2	3.00	SIC
156-39-390	3.90	195	2	3.00	SIC

LEGION CARP

S.H.M.R. CARBON



A wonderful telescopic rod, only 106cm when it's closed. The secret lies in the design: seven sections that can provide enormous power both during casting and during retrieving. Like all the telescopic rods, it has been designed for quick sessions. The Legion Carp is

a medium-high level rod and its action is very similar to that of a two-pieces construction. Equipped with double leg Sic guides.

Code	Length	C. Length	Sections	Test lbs	Guide
156-24-350	3.60	106	7	3.00	Sic



IMPRESSION

CROSSED REINFORCED S.H.M.R. CARBON



Telescopic rod in High Resistance Carbon reinforced with Carbon Tape spiral wrapping and Carbon Yarn Cross wrapping. Available in 3,60m length with 3,00 Lbs test curve. The Impression has a very powerful action for distance cast-

ing, and it is equipped with Super S-SIC guides. Very manageable and easy to transport when closed.

Code	Length	C. Length	Sections	Test lbs	Guide
156-22-360	3.60	107	7	3.00	Sic



INSOLENCE

S.H.M.R. CARBON



Many anglers prefer telescopic rods because they are obviously very easy to transport and because they can be prepared faster. The NEW INSOLENCE range of rods are very strong and characterized by a progressive action. Made in HR Carbon

and kevlar yarn wrapping to increase the power. Equipped with SIC guides, anti-slip EVA handle and latest design ergonomic screw reel seat. Ideal for those anglers who are looking a practical rod with great performance.

Code	Length	C. Length	Sections	Test lbs	Guide
156-29-360	3.60	84	7	3.00	Sic
156-29-365	3.60	84	7	3.50	Sic
156-29-390	3.90	84	7	3.50	Sic



SURFCASTING 2 & 3 SECTIONS

Great dedication and countless working hours made the Trabucco brand a landmark in the surf casting universe, not only in Europe but in the whole world, where top anglers of the most prestigious national teams, such as UK and Ireland, decided to use Trabucco rods for the most important competitions. To stop now it will be crazy, because the world is going ahead and the surf casting of nowadays is already light-years far from the surf casting of just 5 years ago. That's why we built a team of experienced competition anglers, to help the brand to switch to the next level and create a new generation of surf casting rods. The results of this co operation is under your eyes and we are really proud of it, because we know that now more than ever before we are ahead of anyone else, on the highest step of the podium.

NEW POETICA KW TORZITE

The new Poetica KW is something really special, it is not a "normal" evolution of the old Poetica, it is a true Copernican revolution. First of all the blank is made of super high modulus CX-2 Nano Tek carbon with low resin content, far lighter but better performing than any other carbon. Then we fine tuned a special tip where the bending curve is distributed to have a softer final part, made of glass, and a harder lower part made of carbon. The name for this special tip is FH-Rip Tip. Such a tip is really pushing during the cast but it is quite sensitive when fishing, even with rough sea. It is not a rod for everybody, it is a rod for demanding people that need a super rod able to cast as no other one, a true competition rod, competing with other anglers, competing with fish very far from the shore, competing with the strength of the sea. The Poetica KW is equipped with best guides ever made: the brand new super high tech Fuji Torzite with Titanium frame. The Poetica is the first surf casting rod featuring such guides! The inner diameter of the Torzite is 15% bigger than other same outer diameter, consequently they help casting even more. The reel seat is a Fuji DNPS Gold Label. Top rod ever!



Code	Length	C. Length	Sections	C.W.	Guide
170-99-160	4.25	145	3	160	Fuji TKWTG
170-99-165	4.50	157	3	160	Fuji TKWTG
170-99-200	4.25	145	3	200	Fuji TKWTG
170-99-205	4.50	157	3	200	Fuji TKWTG
170-99-250	4.25	145	3	250	Fuji TKWTG
170-99-255	4.50	157	3	250	Fuji TKWTG

SPECIFICATIONS:



FUJI GOLD REEL SEAT

On the Poetica MN range, we selected only the best components and as reel seat we used the ultra reliable Fuji Dnps gold label, entirely built by graphite it offers a great strength, ergonomic and designed to last longer.



BUTT CAP

The rod's butt ends with a soft rubber handle, which provides the perfect grip to control the rod during most quick and powerful casts. The rounded butt cap is particularly useful to lock the rod to the groin when a big fish is being retrieved.



FH RIP TIP

The Nano Tek high modulus carbon sheet, which gives power to Poetica's blank, sweetly blends into softer materials to provide the right sensitivity to detect fish bites. But the conversion is gradual, within the tubular top section, and this requires high class technology to avoid weak points and curve imperfections, which would cause a bad power transfer. All over the world, this concept is well known as "multi-action tip", but it's not equally common the process of layer's overlapping and fusion which bring to a perfect result, inch by inch.





POETICA KW TORZITE

The top of the top, the buttonhole of the Trabucco surf casting range cannot have a different name than Poetica, a name that gained reputation at the highest level of the international competitions.

Fuji TORZITE™

TITANIUM
Ultralight Titanium frame.

TORZITE™
-40%

SIC

Compared to SIC guides of same size, a Torzite guide offers a 15% wider ring, offering more room to running line. In addition, less weight applied to rod's blank (20-30%) means that it has more freedom to fully develop its reactivity, with great advantage on casting distances.



ULTRA LOW FRICTION

Torzite's gently round cross section shape allow the ring to contact line in double the length compared to the Sic. Thanks to it, the pressure to the ring is reduced half compared to the Sic.

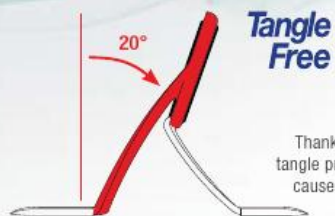

During their endless research and development activity, Fuji engineers found the most advanced ceramic with a very compact structure and extremely smooth surface, being 40% lighter than Silicon Carbide (SIC).

Thanks to a dramatically angled ring, Fuji solved the line tangle problem forever. A common problem which normally causes time loss, sometimes line breakage and, in worst cases, even rod breakage.

The load is spread in the **POINT**

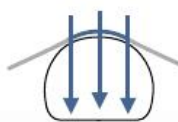

The load is spread in the length of the contact.

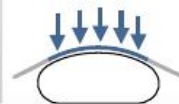

IMPERA

NEW IMPERA

FAST REACTION BLANK
X-TRA CASTING PERFORMANCE

Zero Friction Blank

HY
HYBRID TIP

TITANIUM GUIDE

Fuji

LRC
LOW RESIN CONTENT

CX2
CARBON NANO-TEK

The new series of surf casting rod Impera is born for competition, designed with the contribution of the whole Trabucco Surf Casting Team that tested the blanks for months. The final result is an excellent combination of performance, light weight and reliability. The rod has been made using the fantastic super high modulus CX-2 Nano Tek carbon, a special super stiff but super light weight material, due to the extremely low percentage of resin. A so powerful but also a so balanced blank is perfect for long fishing sessions that won't break your back in two. The tip is hybrid, a solid carbon tip that is perfectly connected to the lower hollow part, strong and sensitive. A so

technological blank deserves top components such as Titanium frame SIC SeaGuide guides and Fuji DNPS Gold Label reel seat.

Code	Length	C. Length	Sez.	C.W.	Guide
171-56-160	4.25	145	3	160	Sea Guide Tit. SIC
170-56-165	4.50	157	3	160	Sea Guide Tit. SIC
171-56-200	4.25	145	3	200	Sea Guide Tit. SIC
171-56-205	4.50	157	3	200	Sea Guide Tit. SIC
171-56-250	4.25	145	3	250	Sea Guide Tit. SIC
171-56-255	4.50	157	3	250	Sea Guide Tit. SIC

SPECIFICATIONS:



CX-2 NANO-TEK LRC

Last generation Super High Modulus Carbon produced with an exclusive process that allow to produce an extremely pure carbon fibre with a very low resin content. Such a pure material greatly enhances the mechanical response to stress, thus being much higher than the Carbon usually used to build fishing rods, and has a very low specific gravity. The final result given by this technology is a super performing, extremely light fishing rod.



SEA GUIDE TITANIUM SIC

The inner stone, made of SIC, is the best you can get in term of smoothness, heat dispersion and abrasion resistance. But the strongest point of the new Titanium guides is undoubtedly the stiffness and the lightness of the frame. Titanium is also salt water resistant, so this material has incredible properties indeed! A rod equipped with Titanium guides will always have superior performance

because the action of the blank will not be influenced by the weight of the guides.



FUJI GOLD REEL SEAT

On the Impera range, we selected only the best components and as reel seat we used the ultra reliable Fuji DNPS gold label, entirely built by graphite it offers a great strength, ergonomic and designed to last longer.



BUTT CAP. Special rubber butt grip with rounded rubber cap, it helps all the operations during the casts or when fishing and additionally it has the function to protect the butt end.

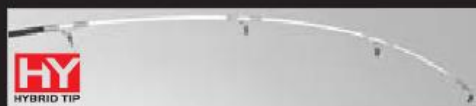

HYBRID TIP. In order to give Impera the highest possible sensitivity, a carbon solid tip has been inserted, glued and carefully wrapped on to the tubular portion of top section. This solution required a specific technology to obtain strength around the joint area and curve perfection of the whole top. The most delicate bites are consequently shown at their best, while at the same time the strike is very accurate and safe, enabling the use of relatively fine hooklinks.



Salvatore Bonaccorso

CASSIOPEA MN 2

FAST REACTION BLANK
XTRA CASTING PERFORMANCE

Zero
friction
reel seat

Fuji

LRC
LOW RESIN
CONTENT

CX2
NANO-TEK



A definitely brilliant rod series, which stands off the average for its interesting list of technical specifications. The blank is made from CX-2 Nano LRC, a low resin content carbon of the highest modulus available. The whole range of casting weight models has an impressive fast reactive action and it can be used in whatever sea or wind condition. The components are top level: genuine Fuji Alconite guides with fluorescent inserts and genuine Fuji Gold Series reel seat. The 4.50 meters versions features a more parabolic action to allow any kind of casting style. The Cassiopea 120 gr, unlike other casting weight models, fits 7 guides, the perfect choice to drive the tighter line coils created by smaller sized reels. More powerful models have 8 guides and must be combined with bigger reels (8000 and 1000 sizes). We want to highlight the heavier model too, a 300 g casting weight rod, one of the most powerful

surf rods on the market. This model is actually able to accomplish any challenge and it is a perfect choice for shark and rock fishing with live bait. The super sensitive tubular carbon tips mounted on each model have been crafted in order to be active also during the casting action, when they help to push your lead to the horizon.

Code	Length	C. Length	Sect.	C.W.	Guide
171-52-120	4.20	145	3	120	Fuji A MN
171-52-125	4.50	157	3	120	Fuji A MN
171-52-160	4.20	145	3	160	Fuji A MN
171-52-165	4.50	157	3	160	Fuji A MN
171-52-200	4.20	145	3	200	Fuji A MN
171-52-205	4.50	157	3	200	Fuji A MN
171-52-300	4.20	145	3	300	Fuji A MN

XPS VELVET PROCAST

NEW

300m / 600m



Specially developed for Surf Casting competitions, it's produced in an intense, warm yellow colour which is quite visible both under daylight and during the night, when the head lamp allows to immediately find the real direction taken by the line. Extremely soft, velvet skinned thanks to silicone treatment and without memory, it flows easily out from the reel's spool, allowing long casts and preventing the inexperienced user from creating line tangles. On the knot side, it's easy to pull tightly, even in larger diameters: on the hook's shank as well as on shock leader it creates neat and small knots.

Find out more on page 209

KRYPTERIA

Hi grade series of powerful yet sensitive surf casting rods, designed in three equal sections with small diameter's blanks. They are built from CX-2 Nano LRC, a special low resin content carbon material. These rods feature a very sensitive solid carbon tip. The Krypteria show peculiar specifications that can be appreciated notably on the 4.50 models, as the moderately fast action make these rods suitable for every casting technique. The light weight and robust blank is reactive and you can feel its casting power in every moment of your casting action. The outstanding components are top quality and salt water resistant: Sea Guide Titanium frame guides with inner SiC ring, Fuji Gold Series ergonomic reel seat and Trabucco rubber butt grip.

SPECIFICATIONS:



TITANIUM GUIDE

The inner stone, made of SiC, is the best you can get in term of smoothness, heat dispersion and abrasion resistance. But the strongest point of the new Titanium guides is undoubtedly the stiffness and the lightness of the frame. Titanium is also salt water resistant, so this material has incredible properties indeed! A rod equipped with Titanium guides will always have superior performance because the action of the blank will not be influenced by the weight of the guides.



FUJI GOLD REEL SEAT

You cannot avoid to use a Fuji equipment when you want a first quality accessory for your rod. Surf Casting anglers usually mistreat their rods, using them in an aggressive environment and in extremely tough conditions. The Fuji Gold reel seat is the best you can get in terms of longevity and safety, always keeping your reel right into its position without any problem for years and years..

FAST REACTION BLANK
XTRA CASTING PERFORMANCE

Zero Resin Content

TITANIUM GUIDE

Fuji

LRC
LOW RESIN CONTENT

CX2
CARBON
NANO-TEK

Code	Length	C. Length	Sections	C.W.	Guide
171-50-120	4.20	145	3	120	Titanium SiC
171-50-125	4.50	157	3	120	Titanium SiC
171-50-160	4.20	145	3	160	Titanium SiC
171-50-165	4.50	157	3	160	Titanium SiC
171-50-200	4.20	145	3	200	Titanium SiC
171-50-205	4.50	157	3	200	Titanium SiC



CX-2 NANO-TEK LRC

Last generation Super High Modulus Carbon produced with an exclusive process that allow to produce an extremely pure carbon fibre with a very low resin content. Such a pure material greatly enhances the mechanical response to stress, thus being much higher than the Carbon usually used to build fishing rods, and has a very low specific gravity. The final result given by this technology is a super performing, extremely light fishing rod.



BUTT CAP

The Krypteria is an outstanding rod that is light and robust. That's why we decided to equip it with a rubber Butt Cap. The rubber sort we used is extremely tough, standing against abrasions and salt water, but it is also extremely light. To some people it can seem a worthless detail but, on the contrary, it is icing on the cake. And we love to take care of our products, even for the smallest details.



NEMESEAN MN

Series of three section's rods based on very well tested blanks, made from CX-1 Micro Pitch Carbon, a strong, reliable and fast reactive material that matches modern market requests. This series features very good salt water resistant finishing and components such as a genuine Fuji Gold Series ergonomic reel seat and Sea Guide Hero Hi-Grade guides with SiC rings. The Nemesea MN is offered at an average price but it is the only rod in this segment whose performance can be compared to top level rods. The wonderful cosmetic does justice to the brilliant action.

Code	Length	C. Length	Sections	C.W.	Guide
171-21-120	4.20	145	3	120	Sea Guide SiC
171-21-125	4.50	157	3	120	Sea Guide SiC
171-21-160	4.20	145	3	160	Sea Guide SiC
171-21-165	4.50	157	3	160	Sea Guide SiC
171-21-200	4.20	145	3	200	Sea Guide SiC
171-21-205	4.50	157	3	200	Sea Guide SiC





FAST REACTION BLANK
XTRA CASTING PERFORMANCE

CV CROSS
 VIBROGrip

Zero
 Friction
 Alligator

Fuji

CY2
 CARBON
 NANO-TEK



NEW X-RIDE SURF



8000
 10000

- XTRA TOUGH**
BODY
- SUPER LIGHT ALU**
- 10Kg**
MAX DRAG
- 12+1 SS**
SHIELDED BEARINGS
- SWR**
SALT WATER RESISTANT

For special techniques such as light surf and beach ledgering it is common to use light weight rods with limited casting weight. Having said that, it is not true you must give in to fish very far from shore. Main problem is that very few reels have the specs that can combine with these light rods. So you need a wide spool reel and, at the same time, a light weight reel otherwise you will compromise the balance between rod and reel.

Find out more on page 172

NEW ATHENA X-TREME

The Athena series was born in the end of 2013 and it has been so welcomed by anglers to deserve after a so short time an upgraded version. The new Athena is made of a very special carbon, whose fibers are wrapper really tight to get an extremely reliable and stiff blank. This carbon, the CX-1 Micro Pitch is one of the reasons why this rod will be among the best sellers for 2015 too. Accurately finished and with a nice brilliant yellow colour, now definitely THE Athena colour, the blank is equipped with SiC corrosion proof

Code	Length	C. Length	Sections	C.W.	Guide
171-68-160	4.20	145	3	160	Sea Guide SiC
171-68-165	4.50	157	3	160	Sea Guide SiC
171-68-200	4.20	145	3	200	Sea Guide SiC



SeaGuide guides. The Fuji DPS reel seat is ultra reliable and will not suffer salt and sand. For the Athena we selected an hybrid tip as well.



Fuji DPS graphite screw reel seat.



Double leg SiC guides



NEW EPICA X-CAST



Maybe it is not evident but the Epica series are very likely the best selling series within the Trabucco assortment. This happens because the Epica rods feature the most advanced solutions and technology, normally displayed on top class rods, at very affordable price. The new XCast series is a very good example of wise designing e top components. Available both in the classic 4.20m length and in the longer 4.50m, much appreciated by peo-

ple engaged in competition. The blank is made of high modulus carbon CX-1 Micro Pitch and it is equipped with first class SiC SeaGuide guides, to reduce the friction with

the line. The stainless steel frame is corrosion free. The Webo DPS reel seat is reliable and will last forever. The ergonomic lower part of the handle will help you to get the best from your casting ability. The tip is hybrid, a solid carbon part that is perfectly connected to the lower hollow part, strong and yet sensitive.



NEW SERENITY COMPETITION

A little for the competition and a little for normal anglers; the Serenity Competition is a rod with very good performance but offered for an affordable price. For sure this rod is one of the more pleasant easy to use on the beach, and this is due to the perfectly balanced blank that can be used for hours with no strain. Casting performance is outstanding due to the building material, the high modulus CX-1 carbon and the smooth SiC SeaGuide guides.

The tip is hybrid, a solid carbon part that is perfectly connected to the lower hollow part, strong and yet sensitive.



Salvatore Bonaccorso



FAST REACTION BLANK
XTRA CASTING PERFORMANCE

CX CROSS WINDING

HY HYBRID TIP

Zero Friction

CX CARBON MICRO-PITCH

Code	Length	C. Length	Sections	C.W.	Guide
171-70-160	4.20	145	3	160	Sea Guide SIC
171-70-165	4.50	157	3	160	Sea Guide SIC
171-70-200	4.20	145	3	200	Sea Guide SIC
171-70-205	4.50	157	3	200	Sea Guide SIC



FAST REACTION BLANK
XTRA CASTING PERFORMANCE

HY HYBRID TIP

Zero Friction

CX CARBON MICRO-PITCH

Code	Length	C. Length	Sections	C.W.	Guide
171-69-160	4.20	145	3	160	K SIC
171-69-165	4.50	157	3	160	K SIC



NEW LANCER SURF



XTRA TOUGH BODY

SUPER LIGHT ALL

4.3:1 GEAR RATIO

6+1SS SHIELDED LEARNERS

SWR SALT WATER RESISTANT



- Aluminium Power Bail with Anti Twist roller
- High strength stainless steel main shaft
- Worm shaft system with slow oscillation
- Machine cut aluminium handle
- Sealed drag, with PTFE coated disks

Find out more on page 173

FIREBIRD



NEW IRIIDIUM PROGRESS



Three sections surf casting rod representing a very good compromise between cost and performance. The high modulus carbon blank is covered by the Zero Friction Blank varnish and it is made for the long distance. Really handy, its action is pretty fast and

accurate during the casting phase. The ergonomic handle on the lower part of the butt section is a great help for casting. The tip is hybrid, a solid carbon part that is perfectly connected to the lower hollow part, strong and yet sensitive.



Code	Length	C. Length	Sections	C.W.	Guide
171-72-200	4.20	145	3	200	MN SiC



IRIDIUM SURF

This rod really stands out of the crowd! This is not only due to its brilliant cosmetic but it is mainly coming for its value for money. At Trabucco we are always committed to give you the best at the lower price. The CX-1 Carbon blank is reliable and fast reactive, with very good casting performance. The hybrid tip is made from carbon and fibreglass and we think to have got the best from both materials. Featuring salt water proof MN SiC guides.



Code	Length	C. Length	Sections	C.W.	Guide
171-44-420	4.20	145	3	200	SiC

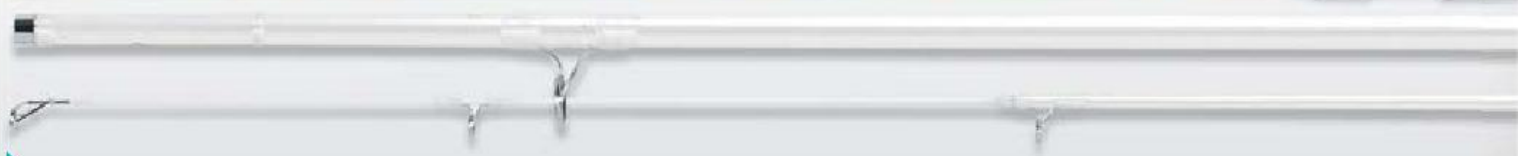

FAST REACTION BLANK

HY HYBRID TIP

Zero Friction Blank

Fuji

CX-1 CARBON



Amazing 3 sections surf casting rod that has been tested for a very long time before to be approved for mass production. The blank is made of High Modulus CX-1 Carbon and it is perfect for long distance and heavy duty fishing. The 200g casting power makes this rod one of the best to use when the sea is really rough. Extreme conditions are made for the Firebird. The tip has been made mixing carbon and fibreglass, in this way the tip is adding extra power during casting but stays sensitive while fishing. The famous Zero Friction Blank and the new casting K frame SiC guides grant longer casts, also in windy conditions. The K shaped frame virtually reduces to zero the friction with the line, avoiding to break it in case it would flow in too wide coils.



Code	Length	C. Length	Sections	C.W.	Guide
171-43-420	4.20	145	3	160	SiC

NEW IRIIDIUM DISTANCE

FAST REACTION BLANK

HY HYBRID TIP

Zero Friction Blank

CX-1 CARBON



Three sections surf casting rod representing a very good compromise between cost and performance. The high modulus carbon blank is covered by the Zero Friction Blank varnish and it is made for the long distance. Really handy, its action is pretty fast and accurate during the casting phase. The ergonomic handle on the lower part of the butt section is a great help

for casting. The low profile SiC guides are very popular in Spain and they give some extra meters to your casts. The tip is hybrid, a solid carbon part that is perfectly connected to the lower hollow part, strong and yet sensitive.

Code	Length	C. Length	Sections	C.W.	Guide
171-71-200	4.20	145	3	200	LP Inox SiC



FOLGORE REVOLUTION



Three sections surf casting rod with stiff progressive parabolic action, the easiest solution for longer casts without any efforts. The tip is hybrid, being made from a mix of High Density Carbon and Fiberglass. We opted for this solution to increase sensitivity to

fish bites and to perfectly manage the fighting fish. The CX-1 Carbon blank is equipped with salt water resistant MN SiC guides.



FOLGORE LONG CAST



Three sections Surf Casting rod with stiff action and real 200 grams casting power. Despite the great power of the blank, the Folgore Surf LC is very sensitive, thanks to the special hybrid tip, made from carbon and solid fiberglass. The blank is made of super reliable CX-1

Carbon and it is equipped with low profile SiC guides: this solution allows longer casts and the use of multipliers. All components are salt water resistant.



FOSTORIA COASTMASTER



New version of the proven Fostoria series. The blank is now more reactive, thanks to the new higher modulus carbon fibres we used. Thanks to this material, the rod is now more balanced too. The Fostoria Coast Master is also much more sensitive thanks to the new hybrid

tip, really useful to spot the more delicate bites and to understand the sea bottom morphology, using the lead as a probe. Equipped with salt water resistant MN SiC guides.



FOSTORIA OVERCAST



Totally new blank for a very well known and appreciated worldwide surf casting rod. The new Fostoria Overcast is made from High Resistance Carbon, a material that grants superior performances both when casting and fishing, thanks to the hybrid carbon/fiberglass

tip. It is evident that every component of this rod is resistant to salt water corrosion, including the low profile SiC guides.



FAST REACTION BLANK XTRA CASTING PERFORMANCE **HY** HYBRID TIP **Zero** **CX-1** CARBON

Code	Length	C. Length	Sections	C.W.	Guide
171-49-420	4.20	145	3	160	SIC MN

FAST REACTION BLANK XTRA CASTING PERFORMANCE **HY** HYBRID TIP **Zero** **CX-1** CARBON

Code	Length	C. Length	Sections	C.W.	Guide
171-48-420	4.20	145	3	200	SIC Low Profile

FAST REACTION BLANK XTRA CASTING PERFORMANCE **HY** HYBRID TIP **Zero** **CROSS** REINFORCED **CX-1** CARBON

Code	Length	C. Length	Sections	C.W.	Guide
171-45-420	4.20	145	3	200	SIC MN

FAST REACTION BLANK XTRA CASTING PERFORMANCE **HY** HYBRID TIP **Zero** **CROSS** REINFORCED **CX-1** CARBON

Code	Length	C. Length	Sections	C.W.	Guide
171-46-420	4.20	145	3	200	SIC Low Profile



Giuseppe Alesi

NEW HISASHI F-31

Specially developed for light surf casting, it's the ideal weapon to search fish when they are particularly shy, as it can present worms in the most natural way. The beak point grants penetration and holding properties, while the long shank offers room for long worms, easing both baiting and disgorging operations. The straight eye can be tied in several ways, saving most of the line's breaking strength.

We recommend to connect the hook through twisted line loop, as it gives the hook-bait total mobility and resists to fish teeth better than single line. The ending barb works as bait keeper.

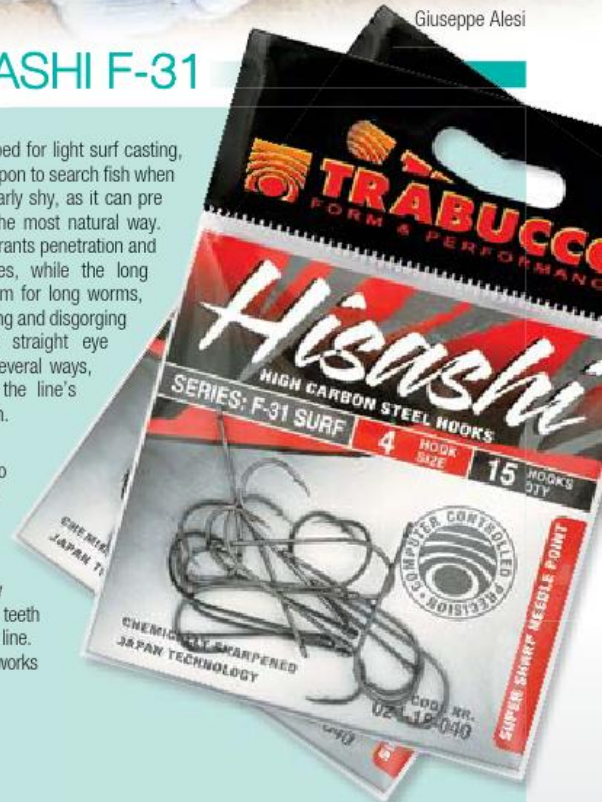

Find out more on page 233

NEW SUSPIRIA HYPERCAST

FAST REACTION BLANK

HY HYBRID TIP

Zero Impedance UltraGraph

CROSSED REINFORCED



The Suspiria is made of high resistance carbon reinforced by a special design of carbon fibers intended to make it more reactive and fast. The 200g casting power is real, making this rod a good choice for people searching for a long distance device. The Suspiria can face heavy sea with no problem and still be enough sensitive to detect bites, thanks to the hybrid solid carbon tip. Equipped with SiC MN guides with stainless steel frame.



Code	Length	C. Length	Sections	C.W.	Guide
171-73-160	4.20	145	3	200	MN SIC

NEW SUSPIRIA LONG RANGE

FAST REACTION BLANK

HY HYBRID TIP

Zero Impedance UltraGraph

CROSSED REINFORCED



The Suspiria is made of high resistance carbon reinforced by a special design of carbon fibers intended to make it more reactive and fast. The 200g casting power is real, making this rod a good choice for people searching for a long distance device. The Suspiria can face heavy sea with no problem and still be enough sensitive to detect bites, thanks to the hybrid solid carbon tip. Equipped with SiC low profile guides with stainless steel frame.



Code	Length	C. Length	Sections	C.W.	Guide
171-74-200	4.20	145	3	200	LP SIC

NEW XTR SURFCASTING PRO TEAM

Nowadays, surf casting is an advanced sea fishing branch, which in Italy has seen a fast development, more than in the rest of Europe; along with thousands of pleasure anglers there are many match surf fans, who like to adopt the finest quality tackle and accessories. To them, Trabucco offers a new range of technical luggage, showing a young and intriguing design, based on black and chartreuse, a trendy colour in between yellow and green, which moved from the fashion world to pervade other fields of the industry. But cosmetic is just one of the interesting points of XTR Pro Team range, because materials and practical solutions are destined to impress the end user surely more than it. Using a waterproof and washable material weighing 1200 denier, bags, rucksacks and rod holdalls are built to last. The addition of plastic boxes with many compartments enables to take full advantage of the inside room to neatly store all accessories. The special paddings, the stiff bottoms, the handles and shoulder belts, the zippers and seams are made with great care and precision.





HYBRID TIP
Both Suspiria display a great fishing sensitivity, thanks to the spliced top including a solid carbon tip.



Find out more on page 312



NEW ADMIRAL STORM RIDER

Three sections surf casting rod made of carbon whose fibers has been interlaced with a specific design that increases stiffness and consequential casting distance. Despite the very affordable price, this rod can deliver very good performance and the casting power of 160 g is absolutely real. Very good rod for those who start

NEW ADMIRAL SEAQUEST

The Admiral Sea Quest is a powerful rod, very good choice for long casting even if it is not too stiff. This action is easier to use and can allow even the newbies of long casting to attend good distance. The high resistance carbon blank is obviously not as fast as other rods, but it can react in a very accurate way. The SiC guides are smoother than others and



NEW ADMIRAL ORIZZONTE

Very strong and reliable surf casting rod able to face heavy sea conditions with no problem. The Admiral Orizzonte is made of high resistance carbon and reinforced in the joints with transverse high resistance carbon bands. The big screw reel seat can easily host large surf casting reels, up to 12000 size and even bigger. The tip is hybrid, a solid carbon part that is perfectly connected to the lower

hollow part, strong and yet sensitive. Stainless steel corrosion proof SiC guides.



Code	Length	C. Length	Sections	C.W.	Guide
171-78-420	4.20	145	3	250	MN SiC



NEW OCEANIC DISTANCE SURF

The new Oceanic is the entry level model for the 3 sections surf casting rod from Trabucco. Despite the very affordable price, it has been designed following the same principles of more expensive rods. The blank is made of HRC (High Resistance Compo-

site) reinforced with a carbon yarn and is super strong and reliable. The stainless steel frame SiC guides are corrosion resistant and super smooth.



to use 3 section surf rods. Also featuring Zero Friction Blank, corrosion free SiC guides and hybrid solid carbon tip.



Code	Length	C. Length	Sections	C.W.	Guide
171-75-160	4.20	145	3	160	S-SiC

the line will pass with o friction. It is possible to use braided lines too. The rod is completed with a wide reel seat and hybrid solid carbon tip.



Code	Length	C. Length	Sections	C.W.	Guide
171-77-420	4.20	145	3	200	S-SiC



Code	Length	C. Length	Sections	C.W.	Guide
170-54-600	4.20	145	3	200	S SiC
170-54-650	4.50	157	3	200	S SiC



CASSIOPEA MX2

The Cassiopea MX2 is the natural evolution of the classic and historical English rods, from whom it takes the basic concepts and contents, changing them according to the most modern needs and the latest technological materials.



AERAS HYPERTEK

Very interesting 2 sections surf rod, versatile and performing long distance casting.



NEW CASSIOPEA MX2



Even if the market in this moment is asking for a large quantity of 3 sections surf rods, for sure the most beautiful rods for surf casting are the 2 sections one, the so called bass rods. The Cassiopea MX2 is the natural evolution of the classic and historical English rods, from whom it takes the basic concepts and contents, changing them according to the most modern needs and the latest technological materials. The blank is incredibly

The tip section, a key part to define the action of a 2 section rod, is FH Rip Tip, that means that the building involves glass and carbon fibers mixing in a progressive way from the top to the base of the tip. Casting power, accuracy of the cast and finally sensitivity, all is depending on this special tip. The Cassiopea MX2 is equipped with the finest components such as a Fuji DPS Gold Label reel seat and Fuji Alconite guides. The lower handle on the butt section is made by a shrinking tube and a hard rubber butt knob, a perfect solution to secure the hand during the casting phase. Put in joint.

Code	Length	C. Length	Sections	C.W.	Guide
171-54-160	4.15	145	2	(2-6 oz) 160 g	Fuji MNA
171-54-200	4.15	145	2	(3-7 oz) 200 g	Fuji MNA
171-54-230	4.15	145	2	(4-8 oz) 230 g	Fuji MNA

stiff and high performing, made from high modulus CX-2 Nano Tek LRC carbon. The fast action is absolutely fantastic and you will experience the most incredible casting sensation.



SPECIFICATIONS CASSIOPEA MX2 AND AERAS HYPERTEK:



FUJI DNPS REEL SEAT

On the Cassiopea MX2 range, we selected only the best components and as reel seat we used the ultra reliable Fuji DNPS gold label, entirely built by graphite it offers a great strength, ergonomic and designed to last longer.



BUTT CAP

The butt end cap is a feature that many don't consider. But in fact it helps all the operations during the casts or when fishing and additionally it has the function to protect the butt end. We've designed also special rubber caps also for the inner sections to prevent any damage during the transport.



FH RIP TIP

Both Cassiopea and Aeras series feature the fantastic FH Rip Tip top section. It has a tubular structure, and it's built through a special technology. In the top area, which is destined to detect fish bites, the high modulus carbon is gradually replaced by lower modulus materials, up to become 100% fiberglass to get the required sensitivity.

NEW AERAS HYPERTEK



Very interesting 2 sections surf rod, versatile and performing long distance casting. The Aeras is made of the equal sections joint with a spigot and made of high modulus carbon CX-1 Micro Pitch. The building structure of the blank gives the angler sensation he cannot feel without a 2 sections rod. The special FH Rip Tip, made of a combination of glass and carbon, has the typical bend of an English bass rod. Equipped with SiC Seaguide guides with stainless steel frame. The reel seat is Fuji DNPS Gold Label and can easily harbor big pit reels.

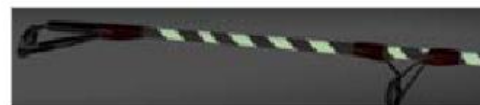

Great visibility during the night, thanks to the glow-in-the-dark tape which wounds the tip.

Code	Length	C. Length	Sections	C.W.	Guide
160-70-100	3.95	200	2	150	Sea Guide Inox SiC
160-70-200	4.15	210	2	150	Sea Guide Inox SiC



SURFCASTING TELESCOPIC

Love and hate. Telescopic surf casting rods don't know half measures. Many anglers just dislike them, but on the other hand, many other will never go fishing without them. We want everybody happy and thanks to our great knowledge and experience that lead us to build the most beautiful 3 sections rods in the world, we think to be able to deliver the best telescopic rods ever. We are so confident in our job that we think that some 3 section's lovers will integrate their own rod range with some of our telescopic! Also for telescopic we invested money, time and attention, we casted thousands and thousands of times, to make our tele-rods the best you can buy.





CASSANDRA MN

It was difficult to do better than the previous Cassandra, very likely the thinner telescopic surf rod in its class on the market. We think we have succeeded, thanks to the use of the fantastic CX-2 Nano Carbon, a material whose molecules are very tightly linked, allowing you to have less resin in the blank and a more fast response during the cast. The tip is short, without any sliding guide, high performance during the casting action but also sensitive during the fishing action. The butt section is completed with a nice aluminium and rubber cap. The salt water resistant equip-

Code	Length	C. Length	Sections	C.W.	Guide
170-88-100	4.20	157	7	100	Sea Guide SiC
170-88-130	4.20	157	7	130	Sea Guide SiC
170-88-150	4.20	157	7	150	Sea Guide SiC

ment includes double legs MN Seaguide guides, non-slip grip and screw reel seat.



Built in CX-2 Nano Carbon.



Aluminium and rubber butt cap.

FAST REACTION BLANK
XTRA CASTING PERFORMANCE

CROSSED REINFORCED

HIGH PRECISION CONTROL

CX-2 CARBON NANO-TEK



NEW LOCUSTA XT

It's the natural evolution of former Locusta, of which it keeps the reactivity that had achieved the approval from thousands of Italian surfcaster, making them say that it was casting like a three section rod! Thanks to Emiliano Tenerelli and Trabucco team work, now the action range is wider, offering different casting weights to satisfy current demand. Technical features also grow, as now guides are from Sea Guide to improve resistance to saltwater and reel seat is the same ergonomic model which until yesterday was available on Cassandra series only. Good news also on the butt grip front, which has been shaped to provide total control when the rod is pushed forward and the energy must be concentrated to reach the targeted distance. Finally,

Code	Length	C. Length	Sections	C.W.	Guide
171-58-120	4.20	165	6	120	Sea Guide SiC
171-58-125	4.50	165	6	120	Sea Guide SiC
171-58-150	4.20	165	6	150	Sea Guide SiC
171-58-155	4.50	165	6	150	Sea Guide SiC
171-58-200	4.20	165	6	200	Sea Guide SiC
171-58-205	4.50	165	6	200	Sea Guide SiC

an already high grade series which steps up, strengthening the Trabucco image in the most dynamic segment of sea fishing.



Stainless steel frame Sea Guide SiC guides.



Graphite screw reel seat with stainless steel moving hood. Rubber ergonomic butt grip.

FAST REACTION BLANK
XTRA CASTING PERFORMANCE

CX-1 CARBON



NEW NIGHTWISH EXTREME CAST

New series oriented to surfcasting competitions, which takes the DNA from former Nightwish, with addition of some important innovations which give it a new identity. The High Modulus CX-1 carbon has been confirmed for the blank, because it gives the rod the correct reaction to best caster's casting requirements, while the guide's configuration is totally revised. Taking advantage from the excellent quality of Sea Guide frames, the technicians of Trabucco team tested some prototypes with larger diameter's guides, obtaining a better line's flow and consequently longer casting distances. In order to provide the best possible control of the casting operation, they even added the same anatomic butt grip of new Locusta. Brilliant!

Code	Length	C. Length	Sections	C.W.	Guide
171-60-130	4.20	165	5	130	Sea Guide SiC
171-60-160	4.20	165	5	160	Sea Guide SiC
171-60-200	4.20	165	5	200	Sea Guide SiC



Stainless steel frame double leg Sea Guide SiC guides



Special shaped butt grip with rounded rubber cap



AEGEAN PROGRESS SURF

Appealing series including two models and built from high modulus CX-1 Carbon, with remarkable tip action. These rods perform extremely well and can stand the comparison with much more expensive series, especially in tough conditions with strong waves and wind. Guides and reel seat are salt water resistant.

Code	Length	C. Length	Sections	C.W.	Guide
171-33-420	4.20	150	6	130	SiC
171-33-425	4.20	150	6	150	SiC



NEW SEATALISMAN CASTMASTER

FAST REACTION BLANK **SENSI TOUCH** **CROSSED REINFORCED**

Within the vast collection of Trabucco telesurf rods, Sea Talisman is the link between the famous top of the range rods and those destined to the pleasure angler. In fact, this series features some quality specifications, like blank's slimmness and responsiveness, but is offered at surprising prices. Therefore, the anglers who like to face their first competitions have good chances without spending a fortune, also finding brilliant reels in the Trabucco line-up to perfectly match these rods. Well refined in the small details, Sea Talisman rods fit MN guides with a special corrosion proof finish, plus the ergonomic graphite reel seat: everything right to bear saltwater injuries and to last long time.

Code	Length	C. Length	Sections	C.W.	Guide
171-59-150	4.20	153	6	150	MN SiC
171-59-180	4.20	153	6	180	MN SiC
171-59-200	4.20	153	6	200	MN SiC



FAST REACTION BLANK **CX-1** CARBON



Graphite screw reel seat with stainless steel moving hood. 5 sections telescopic blanks made from High Modulus carbon CX-1.



SENSI TOUCH **Zero Friction** **CX-1** CARBON



ADMIRAL MASTER SURF

FAST REACTION BLANK **Zero Friction** **CROSSED REINFORCED**



Nice series of telescopic six sections surf rods with tip action. The overall stiffness of the blank is good and allows good casting performances, all offered at a competitive price. This series is equipped with salt water resistant components and dressed, as always under the Trabucco brand, with a very nice cosmetic.

Code	Length	C. Length	Sections	C.W.	Guide
171-31-420	4.20	148	6	130	SiC
171-31-425	4.20	148	6	150	SiC



Walter Sarret

SURF TACKLE

NEW

Accessories range for surf fishing rig preparation. Each and every item has been designed to increase your fishing experience and to get maximum results from your rigs.

All the accessories has been made in anti corrosion materials and so they can with stand the salt water.



Find out more on page 319

SEA RIG TACKLE

Accessories line for salt water rig preparation, both for boat or surf/beach fishing. Each and every item has been designed to increase your fishing experience and to get maximum results from your rigs.



Find out more on page 320

ADMIRAL MAGNUM SURF

The Admiral Magnum Surf is a series of rods as the market requires: long telescopic (4.20 meters) and with several options about different casting power. The carbon cross reinforced High Modulus Carbon blank features a medium tip action, so it is possible to cast a mile without fatiguing your back and even if you have not a great knowledge of casting techniques. The sensitive tip allows you to fully control your prey and to force it over the wave if you need to do so. These rods are equipped with SiC guides

and Zero Friction Blank, the very same finish that we use on top level rods.

FAST FRICTION BLANK

Zero Friction Blank

CROSS REINFORCED

Code	Length	C. Length	Sections	C.W.	Guide
171-63-120	4.20	142	5	120	SIC
171-63-160	4.20	142	5	160	SIC
171-63-200	4.20	142	5	200	SIC



ANDROMEDA

Andromeda family is a classic example of Trabucco's vocation to follow all traditions, trends and even the slightest variations within each single fishing style. A solid tip version, another with tubular top, a third one with special guide's configuration. Different solutions and performances according to the actual conditions of use on the beaches of Mediterranean and not only.





ANDROMEDA TEKNO SURF



Surf Casting series fully made of High Resistance Carbon reinforced with Carbon tape in all the point that are subjected to higher stress. These rods are specifically designed to get a strong tip action. The short tip section is solid, strong and sensitive at the same time. This solution allows also more accurate casting. The SiC guides can be used with braided lines. Screw reel seat and non slip handle.

Code	Length	C. Length	Sections	C.W.	Guide
171-25-130	4.20	142	6	130	SiC
171-25-150	4.20	142	6	150	SiC
171-25-180	4.20	142	6	180	SiC

ANDROMEDA TEKNO CAST



Surf Casting series fully made from High Resistance carbon with tubular carbon tip to enhance the casting power. The 5 sections blank has a slim diameter in the butt section and it allows an easy casting also to surf casting beginners. More expert anglers will not miss to achieve really long distances with these rods. The blanks are reinforced in all areas subjected to extreme stress during casting. SiC guides.

Code	Length	C. Length	Sections	C.W.	Guide
171-26-130	4.20	142	5	130	SiC
171-26-150	4.20	142	5	150	SiC
171-26-200	4.20	142	5	200	SiC

ANDROMEDA OCEAN MASTER



A powerful telescopic rod, designed for people who like to experience surf casting with strong rods. The tip is strong and stiff, as usually requested by Atlantic ocean anglers, and guides are "Pipe style", with first one foldable. This is the right rod for Spanish, Portuguese and French market. The cosmetic is eye catching and components are all salt water resistant.

Code	Length	C. Length	Sections	C.W.	Guide
171-24-420	4.20	117	4	250	SIC MN



SEARIDER MASTER BEACH



Sensitive rods designed for salt water light fishing, both from the shore and from piers and breakwaters. It can be used from the shore fishing for striped breams when the sea is calm, being able to good distance casting without spoiling the more delicate baits. It can be used from piers and breakwaters using feeders with maggots for all the marine fish that love it, such as sea bass and gilt head bream. The action of the blank allows the use of low diameter hook length.

Code	Length	C. Length	Sections	C.W.	Guide
169-19-360	3.60	121	5	200	S-SiC
169-19-390	3.90	134	5	200	S-SiC



NEW AVALON GALAXY SURF



Good telescopic rods which take life from a nicely balanced mix of carbon and fibreglass to serve pleasure anglers fishing from the beach as well as from the rocks, where the reliability sits on top of their wish list. The pure carbon is employed on joint's cross reinforcements and to create the white painted solid tip, because the positive end of any fishing session depends mostly from the "communication" between fish and angler. The strong double leg guides, wrapped carefully, feature the vital SiC ring to resist from abrasion caused by salt and sand brought in by the line. Those elements are the worst enemy of any guide, and Trabucco team know it well!

Code	Length	C. Length	Sections	C.W.	Guide
170-41-100	4.00	146	5	150	S-SiC
170-41-200	4.20	146	5	150	S-SiC



Double leg guides with SiC ring.



Graphite screw reel seat with metal hoods.

AVALON SURFCASTING



Surf casting rods series developed for people who starts to practise this technique. Blanks are all made from carbon to offer very good performance at a little price. The series is made of two models of 4.00 meters and having casting power of 130 and 150 g. the best actions to face most of the typical fishing situations

on the shores. The telescopic blank is easy to transport and it is really easy to use, allowing longer casts even to inexperienced people.

Code	Length	C. Length	Sections	C.W.	Guide
170-53-230	4.00	132	5	130	S-SiC
170-53-250	4.00	132	5	150	S-SiC





SEARIDER PRO SENSOR



Among the materials available in the industry, High Resistance carbon is one of the most simple ones, but is worldwide used for its properties to bear high stress and for doing it on the basis of long time term. That's why Trabucco technicians trusted it when designed these Sea Rider, as they liked to offer to newcomers or occasional surfers rods which should have been safe also in front of some inevitable misuse. The top section is made from solid carbon to grant sensitivity and strength, while double leg guides have SIC ring. Reel seat comes from Trabucco's top of the range, with upper hood which is integrated in the shape and lower one screw driven for total safety.

Code	Length	C. Length	Sections	C.W.	Guide
169-20-400	4.00	146	5	150	S-SiC
169-20-420	4.20	146	5	150	S-SiC

OCEANIC SURF MASTER



Extremely robust surf casting rods, whose blanks are made from composite carbon reinforced in all the sections subjected to higher stress. The casting powers, 150 and 200 g, make them suitable to rough sea conditions and for rock fishing using live baits. All the guides are double leg and feature a salt water resistant stainless steel frame. The S-SiC guides are braided lines friendly. We added a screw reel seat for improved strength and safety.

Code	Length	C. Length	Sections	C.W.	Guide
170-54-250	4.00	132	4	150	S-SiC
170-54-300	4.00	132	4	200	S-SiC



AVALON PRO SURF 6500



The Avalon Surf is offered to an affordable price and designed for those who want to take their first steps in the surf techniques. It shows an elegant cosmetics with an ultra reliable mechanics.

Extremely lightweight despite the size, Avalon Surf features a graphite body and spool, the AS line roller, super balance system and the power handle ends with a soft ergonomic knob. Available in two colors (Red and Blue) for an elegant combination with Avalon rods.



SPOOLED WITH XP-Line

Find out more on page 181



LIGHT SURF & BEACH LEGERING

Light Surf and Beach Legering are typically Italian fishing styles, born to adapt the original surf casting to the conditions of the Mediterranean sea, where tides are minimal and waves not as powerful as in the ocean. Both funny and highly specialized, they enable to catch big fish, so that reliable tackle is absolutely a must. Nowadays, Trabucco offers to the wide public of fans a complete range of rods, which have been developed and refined in close cooperation with a team of experts. Blanks which can accurately cast at great distance even the lightest lead, with the sensitivity to detect the most shy bites. Actions which are perfect to employ light lines and sophisticated rigs, engineered to maximise the pleasure coming from the direct contact with the fish.



NEW CATTURA MN2 BEACH



The Cattura is so famous among the Beach Legering rods that it does not need any presentation. The Cattura MN2 series is now larger, with the brand new 4..50 m 120 g casting weight model. We received so many requests for a model that could be able to cast farther and still be super sensitive that we decided to design it. The new 4.50m 120 g is the perfect solution for super sensitive fishing at very long distance. We remind you the whole Cattura M2 series feature CX-2 Nano LRC carbon blanks, a material that is almost free of resins and so it becomes more reactive and lighter. All the rods are equipped by 3 solid ultra sensitive carbon put in tips, able to detect bites and to "read"

the bottom roughness like a sonar! The first class components include original Fuji Alconite guides and Fuji Gold reel seats.

Code	Length	C. Length	Sections	C.W.	Guide
170-96-420	4.25	144	3+3	100	Fuji A MN
170-96-450	4.50	155	3+3	100	Fuji A MN
170-96-455	4.50	155	3+3	120	Fuji A MN NEW
170-96-500	5.00	170	3+3	120	Fuji A MN

SPECIFICATIONS:



FUJI ALCONITE GUIDES
The guide assembly made by Fuji Alconite is the very best on the market! The stainless steel frame supported by Alconite stone (hard and perfectly smooth) provides the best slip of the line.



FUJI GOLD REEL SEAT
On the MN range, we selected only the best components and as reel seat we used the ultra reliable Fuji Dnps gold label, entirely built by graphite it offers a great strength, ergonomic and designed to last longer.



BUTT CAP
The butt end cap is a feature that many don't consider. But in fact it helps all the operations during the casts or when fishing and additionally it has the function to protect the butt end. We've designed also special rubber caps also for the inner sections to prevent any damage during the transport.



SOLID TIPS
Solid Tips Three tips are supplied with the rod:
Green: Super sensitive for pier fishing.
Yellow: Super calibrated for fishing without shock leader.
Red: Tougher action for shock leaders use.



SIRENIA MN



Innovative 3 sections blank designed to provide a rod with single tubular tip showing great sensitivity. The rod is extremely light due to the use of the CX-2 Nano Tek Carbon and its bending curve is progressive and reactive enough to get casting performance very close to stiffer surf casting rods. This is really an outstanding example of good engineering, where Trabucco team put on the table his own fishing experience along with know-how in selecting the best materials and details. Components are at top level and include SiC Sea Guide guides with titanium

corrosion free frame, Fuji Gold reel seat and Trabucco aluminium/rubber butt cap.

Code	Length	C. Length	Sections	C.W.	Guide
170-94-420	4.20	144	3	100	SiC
170-94-450	4.50	157	3	100	SiC
170-94-500	5.00	170	3	100	SiC

SPECIFICATIONS:



TITANIUM GUIDES
The inner stone, made of SiC, is the best you can get in term of smoothness, heat dispersion and abrasion resistance. But the strongest point of the new Titanium guides is undoubtedly the stiffness and the lightness of the frame. Titanium

is also salt water resistant, so this material has incredible properties indeed! A rod equipped with Titanium guides will always have superior performance because the action of the blank will not be influenced by the weight of the guides.



FUJI GOLD REEL SEAT
You cannot avoid to use a Fuji equipment when you want a first quality accessory for your rod. Surf Casting anglers usually mistreat their rods, using them in an aggressive environment and in extremely tough conditions. The Fuji Gold reel seat is the best you can get in terms of longevity and safety, always keeping your reel right into its position without any problem for years and years.

ment and in extremely tough conditions. The Fuji Gold reel seat is the best you can get in terms of longevity and safety, always keeping your reel right into its position without any problem for years and years.



BUTT CAP
The Sirenia is an outstanding rod that is light and robust. That's why we decided to equip it with a rubber Butt Cap. The rubber sort we used is extremely tough, standing against abrasions and salt water, but it is also extremely light. To some people it can seem a worthless detail but, on the contrary, it is icing on the cake. And we love to take care of our products, even in the smallest details.



NEW XANDRIA MN BEACH

3 sections Beach Legering rod equipped with 2 put in sensitive tips made of solid carbon. The new Xandria project has been developed with the supervision of Giuseppe Alesi, famous light surf Italian champion, to achieve a perfectly balanced and light blank, able to cast at distance. The Xandria has a very fast action that is perfect for smooth or just rough sea, when it can still cast at distance with relatively light leads. Equipped with corrosion free SiC guides.



Ergonomic graphite screw reel seat with steel lower hood. Special rubber butt grip with soft, rounded cap.

Code	Length	C. Length	Sections	C.W.	Guide
171-79-420	4.20	144	3+2	100	SiC
171-79-450	4.50	155	3+2	100	SiC



Two interchangeable carbon quiver tip:
stiff / red
yellow / medium



Giuseppe Alesi

NEW FOLGORE BEACH

The Folgore Beach Casting features a very small diameter, super balanced blank. The diameter of the blank of the 4.50 model at the reel seat is just 20mm, and for the 4.20 is as small as 18mm. So the Folgore is the rod you must choose for all the finesse fishing techniques from the beach, with smooth and just rough sea, when it is able to present the baits at a good distance and great accuracy. The blank is made of super high modulus CX-1 carbon and it is strong enough to fight big gilt-head bream. It is equipped with 2 solid carbon put in tips for different casting weights and with stainless steel frame SiC guides. Great value for money.



Two solid carbon interchangeable tips: red (stiff), yellow (medium).

Code	Length	C. Length	Sections	C.W.	Guide
171-76-400	4.00	137	3+2	100	SiC
171-76-420	4.20	144	3+2	100	SiC
171-76-450	4.50	155	3+2	100	SiC





XENOS XOS 6000



The Light Surf technique almost never needs big pit reels, mainly to avoid to compromise the rod balance: light surf rods usually never exceed the 120 g casting power. The Trabucco Xenos XOS 6000 is the perfect reel for this technique thanks to its features: a wide diameter spool that helps to cast longer distances; a medium-low ratio to grant a great cranking power in every situation; an aluminium spool to spool braided lines too. Xenos gears are first quality and designed in Japan, they are supported by 6 stainless steel bearings for perfect smoothness and reliability.

SPECIFICATIONS

- Rotary Flat Oscillation System
- V-Shaped Rotor
- Cold Forged 1 Touch Aluminum Handle
- Front Drag System with Sealed Ptfte Coated Magnum Drag Washers
- Cnc Machine Cut Long Cast Superlight Aluminum Spool



Code	Model	Weight	Gear Ratio	Spool Capacity
038-65-600	6000	598	5.0:1 (98cm)	Ø 0.405mm-230m

NEW XPS LONG CAST FLUO

Xps LongCast Fluo is a high strength line which has been specifically designed as an extreme distance casting line for all sea techniques and which will improve range by around 15% compared with conventional lines. It's super soft, and smooth thanks to an advanced silicon coating which improves abrasion resistance too.

LongCast works equally well when used on either a multiplier or fixed spool reel.



Find out more on page 208

CEPHALONIA MN

A five meters rod is not only useful, we could say indispensable in competitions. Trabucco developed this seven section's rod made from CX-2 Nano-Tek Carbon, whose fantastic blank is able of fully unleashing all the power needed to cast a hundred grams, while remaining very sensitive in the management of the minimal weight of 50 grams. The components are of high standard, such as corrosion proof guides and screw reel seat with stainless steel hoods. The elegant and useful Trabucco rubber butt cap complete what is undoubtedly one of the best competition rods in the market!

Code	Length	C. Length	Sections	C.W.	Guide
170-87-500	5.00	159	7	50-100	SiC



FAST REACTION BLANK
XTRA CASTING PERFORMANCE

CW CROSS WRAPPING

CX-2 CARBON NANO-TEK



ORACLE XR

This telescopic beach legering rod is a really interesting model, which stands up within the vast range of already brilliant rods. Just perfect for light beach fishing, it's made from high grade CX-1 carbon. Casting range is quite high, 120 grams, but the blank is lightweight, easy to use and well balanced, as per the top of the range models. Very good components such as the salt water proof guides, ergonomic graphite reel seat and rubber butt grip are completing this good rod.

Code	Length	C. Length	Sections	C.W.	Guide
170-81-420	4.20	151	5	120	SiC



FAST REACTION BLANK
XTRA CASTING PERFORMANCE

Zero
SPINNING RESISTANCE

CX-1 CARBON

NIGHTWISH EXTREME BEACH



FAST REACTION BLANK

Zero
SPINNING RESISTANCE

CX-1 CARBON



Telescopic rod made from high grade CX-1 carbon in 5 sections with tip action, very light blank but still able to cast far from the shore, as requested by modern Beach Legering. Tip section is made from solid carbon and all components are salt water protected, from the graphite reel seat to the SiC guides.

Trabucco team can be really proud of this project.

Code	Length	C. Length	Sections	C.W.	Guide
170-83-420	4.20	143	5	100	SiC





AEGEAN PROGRESS BEACH



Magnificent telescopic rod for Beach Ledgering featuring two solid carbon put in tips. The fast reaction blank has been made from High Modulus CX-1 Carbon and its diameter is very thin, even if it is also very good for long casting action. Max power is 100 g, but, taking advantage from the two tips, you can actually fish from 20 to 100 g without any problem. The Aegean Progress Beach has a high class finishing, with Sensi Touch butt section and Zero Friction Blank painting. Ergonomic graphite reel seat, SiC single leg guides and rubber butt grip with fighting cap are nice additions.



The rod is supplied with two interchangeable tips.

Code	Length	C. Length	Sections	C.W.	Guide
171-65-420	4.20	125	4+2	100	SiC

BAIT INDICATOR PRO SURF



Designed in conjunction with Trabucco Surfcasting Team, this is the latest innovation in the surfcasting bite detection. The device must be applied on the reel line between the first and second guide from the butt, adjusting the weight according to the sea conditions: the heavier the weight, the less sensitive the indicator. Mn Surf Indicator can be used either by day, fitting the specially provided multicolor antenna, or by night, fitting a 4.5mm chemical light.



Find out more on page 318



LOCUSTA TEKNO MORMORA

True fast action Beach Legering blank, able to cast small weights up to 100 grams beyond the 100 meters mark. The CX-1 High Modulus Carbon blank has a tip action that is able to absorb the biggest fish runs, avoiding to break the smallest diameter hooklength. Due to the very light weight, it is the perfect rod for active fishing, that is keeping the rod in hand, slightly trolling the bait over the sandy or muddy bottom to tease fish reaction. The extra sensitive tip allows to detect even the shiest bites. SiC guides.



Code	Length	C. Length	Sections	C.W.	Guide
171-66-420	4.20	123	5	100	SiC

SEATALISMAN BEACH MASTER

Two rod's series for Beach Legering. The casting vocation of the Sea Talisman, whose casting power is max 100 grams, is enhanced by the Zero Friction blank finishing. Available in two versions, 4.00 and 4.20 meters, with the latter very good for competition purposes. The light weight and reliable blank is made from High Modulus CX-1 Carbon, one of the finest carbon fibres in the market nowadays. The non slip handle is covered by the special Sensi Touch varnishing. SiC guides.



Code	Length	C. Length	Sections	C.W.	Guide
171-62-400	4.00	145	5	100	SiC
171-62-420	4.20	159	5	100	SiC



ADMIRAL MASTER BEACH

Lightweight but powerful, the Admiral Master Beach is made from crossed reinforced carbon for extra reliability. The blank is telescopic in 4 sections, with 2 interchangeable tip sections with different casting power and action, max casting weight 100g. The two tips are essential in all those situations when instead to change your rod it is more easy, and less expensive, just to change the tip in order to adapt your technique to the changed conditions. The lighter tip can also be used in combination with feeder and maggots. This rod is extremely eclectic and versatile, and should never miss in the bag of the passionate beach angler.



Code	Length	C. Length	Sections	C.W.	Guide
171-64-400	4.00	121	4+2	100	SiC

ANDROMEDA BEACH MORMORA

Very light Beach Legering rod, with an impressive value for money. The blank is made of 5 sections of reinforced High Modulus Radial Carbon, and develops a progressive action during the casting, being able to cast in distance even very light leads. As it is to understand from the name, this rods has been designed for mormora (striped bream) fishing from the beach, and it can be used as well for other elusive salt water fish, like the gilt head bream. All the guides are double leg S-SiC.



Code	Length	C. Length	Sections	C.W.	Guide
170-37-400	4.00	142	5	100	SiC



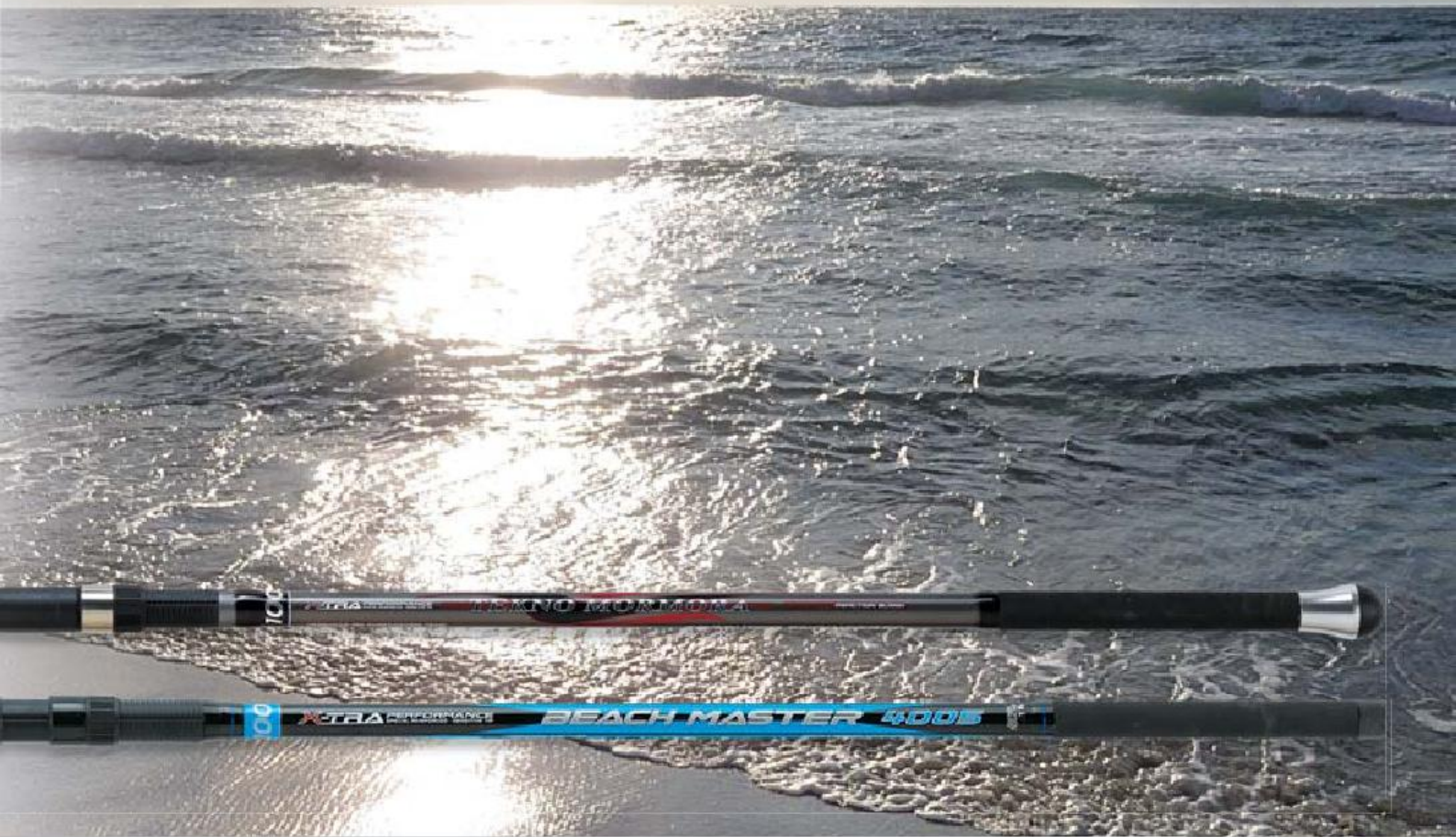

FINGER PROTECTOR



Our Finger Protector is a small but really important accessory who can't miss in the tackle box of any beach caster. Even when casting at extreme distance with heavy lead your finger will be safe, no more injury on your finger. The sensitivity will not be effected as we have used a very soft fabric, and the soft neoprene cuff can fit to any size of wrist.

Emiliano Tenerelli

Find out more on page 319

MAX PLUS PHANTOM

NEW

A few hours within waves, which carry sand and debris and which continuously rub it against the bottom, for the main line are the most severe quality test. But no problem for the Phantom of new Trabucco Max Plus range, which is well protected against abrasion, therefore presenting itself as the ideal one for light surf and beach legering. The crystal clear look is a real plus in the particularly clean waters, while the sensible softness helps a lot while tightening any sort of knots, as their volume results smaller.



150m / 300m / 1000m

Find out more on page 216



TELEBOAT RODS

From tackle point of view, boat fishing is a mix of tradition and evolution, with a wide background and, at the same time, a strong potential for wide growth in the whole Mediterranean Sea. Rods must be first of all reliable, then adapted to local needs, then nicely priced, and all these are fields in which the Trabucco engineering is naturally

succeeding, thanks to an advanced technology and thanks to the attention about the finest details in term of action and components. Great results are waiting for you: just go out with your boat and be sure that everything will be easier with these fantastic rods.

ASTORE SEA POWER



Three telescopic boat rods for light drifting with some great properties: extremely thin talons, amazingly sensitive and with a perfect action. They are so a nice mix of technology, innovation and experience, supported by a CX-2 Nano Carbon Tek material. The blank is thus really powerful but always balanced and light weight. The blanks are built in 6 sections plus 2 put in tips, one in solid carbon and one in solid fibreglass, both coming with guides. The fibreglass

tip has been chosen for pelagic fishes such as: bonito, mackerel and little tunny. The carbon tip is more indicated for bottom fishing with weights from 30 to 200 g for other kind of

fish: grouper, snapper, conger and sea bream. Equipped with SiC stainless steel double leg guides. The three sections above butt are adjustable to allow the user adapt the rod's length to fishing conditions.

Code	Length	C. Length	Sections	C.W.	Guide
162-20-100	5.00	143	6+2	100	SiC
162-20-200	5.00	143	6+2	200	SiC
162-20-300	5.00	143	6+2	300	SiC



Saverio Rosa

VANADIA XT POWER



With this telescopic series, Trabucco engineers managed to design a medium-heavy bolentino rod with slim profile blanks offering a stunning power at the same time. Vanadia XT Power is a rod which offers plenty of stiffness, a quality tool destined to the demanding angler who likes to quickly lift the strongest fish from the sea bottom, avoiding that they find some rocks or snags to cut the line. Vanadia XT Power is supplied with two interchangeable solid fibreglass tips which provide the required sensitivity, while the power body leaves no time to the fish to produce any fast run. Guide's configuration is double leg guides on butt and section above, then single legs to follow rod's action. All have SiC ring to allow braided line's use.

Supplied with 2 interchangeable tips.

Code	Length	C. Length	Sections	C.W.	Guide
162-22-400	4.00	149	6+2	160	SiC
162-22-500	5.00	151	7+2	160	SiC





Saverio Rosa



Fuji LS stainless steel reel seat. Two interchangeable tips: one made from solid carbon, the other in solid fibreglass, both carefully wrapped with guides.



VANADIA MASTER SEA

SENSI TOUCH 2 FLEX XTIP CX-1 CARBON MULTI LENGTH SYSTEM

Telescopic rod series made from CX-1 carbon, perfect to face the toughest fights with difficult fish. The action is more parabolic compared to Haws Albacore series to reduce the stress to hooklinks which, consequently, can be finer and of course more efficient. The structure is well reinforced in the key areas to optimize power, strength and lightness. The series is made of two rods of 4 and 5 metres; both fit an adjustable length device, which allows the rod to be used at one metre shorter. Each rod is supplied with two interchangeable solid fibreglass tips to offer a different grade of sensitivity, double leg guides featuring stainless steel frame; butt handle coated with a special paint to provide fantastic grip.



Two different power interchangeable tips.

Code	Length	C. Length	Sections	C.W.	Guide
162-47-400	3.00/4.00	130	4+2	300	SiC
162-47-500	4.00/5.00	130	5+2	300	SiC

VANADIA POWER ROCK

SENSI TOUCH TTIP CX2 CARBON NANO-TEK MULTI LENGTH SYSTEM

Telescopic rod dedicated to rock fishing, boat fishing and livebait bolentino. The full CX Nano Carbon blank provides to this rod a perfect balance, perfectly combined to the extreme power. This allows you to lift and land even the bigger fish and to face extreme fighting without any problem. All components are quite strong and saltwater proof, from double leg SIC guides to the plate reel seat with rubber support. The telescopic top section is made from solid carbon and painted in fluo orange for bite detection. Length is adjustable, thanks to the rubber device on section above butt.



Code	Length	C. Length	Sections	C.W.	Guide
162-48-450	3.50/4.50	148	6	200	SiC
162-48-550	4.50/5.50	153	7	200	SiC



ATTRACTIVE BOAT MASTER



Power and control: two words summarize the features of this perfect instrument for the bolentino fishing. A maximum casting weight of 300 grams in a four meters rod, built in four sections with two interchangeable solid tips. Originally designed for a medium heavy bottom fishing at good depth, this rod takes advantage from the total length of four meters to be also excellent for light drifting, of course using large diameter lines to handle fights in total safety. The blank is made from CX-1 carbon and has a cross reinforcing carbon braid that makes it a secure and perfect partner in any fishing situation. Fitted with SIC stainless steel frame guides.



Supplied with 2 interchangeable tips.

Code	Length	C. Length	Sections	C.W.	Guide
162-46-400	4.00	140	4+2	300	SIC



HAWS

HAWS ALBACORE

Power, rigidity and lightness are the main characteristics of this rod, which is without doubt the best on the market in this category. A rod built without any compromise made from CX-1 carbon, strengthened by high modulus carbon yarn wrapping. The handle is made by a rubber shrink tube process for perfect control during the casting and the fight.

The section above butt fits a rubber device to adjust length at one metre shorter. Three interchangeable solid tips allow to adapt rod's sensitivity to fishing conditions. A recommended sea rod for Bonito, Sea Bass and Mullet.

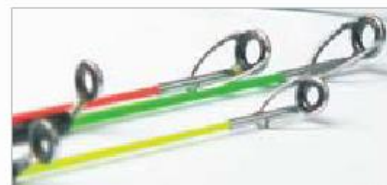

Code	Length	C. Length	Sections	C.W.	Guide
162-41-500	4.00/5.00	142	5+3	5-150	SIC
162-41-600	5.00/6.00	152	6+3	5-150	SIC



SEATALISMAN TEKNO BOAT

This is a perfect combination between a bottom fishing boat rod and a light drifting rod. Action is medium heavy and can be used for fishing snappers and groupers. With these species of fish it is key to be able to counter fight the initial run in order to avoid the breaking the line on bottom rocks. The whole blank is so active during the fight, with a sensitive tip that detects the bites and powerful lower sections that will tire the fish. The starting guide is double leg, while all the other are single leg, to have a better action and lighter weight. The Sea Talisman features two different interchangeable tips, one is made from solid glass while the other is made from solid carbon; the components resistant to corrosion, with graphite reel seat and stainless steel frame SiC guides.

MULTI LENGTH SYSTEM SENSITIVE TOUCH 2 FLEX XTIP CX-1 CARBON



Code	Length	C. Length	Sections	C.W.	Guide
162-61-400	4.00	130	5+2	150	SiC



rod fully bent, then netted an albacore or a snapper while they were just waiting for an ordinary fish, whose expected weight should have been a few hundred grams?

HAWS RED SNAPPER

2 FLEX XTIP CROSSED REINFORCED CX-1 CARBON



Developed in two different lengths, these rods show strength and stiffness to easily handle 200 grams weight. Entirely made from High Resistance carbon, are supplied with two interchangeable sensitive solid tips (1 fiberglass + 1 carbon) for use with different weights. Thanks to short closed length, these rods are easy to carry and to store on the boat. Fitted

with double leg SiC stainless steel guides and a strong screw reel seat.

Code	Length	C. Length	Sections	C.W.	Guide
162-42-350	3.50	119	6+2	200	SiC
162-42-400	4.00	121	7+2	200	SiC



ATTRACTIVE ADRIATICA

Beautiful rod for boat and light drifting. The CX-1 high modulus carbon blank is stiff

and progressive, allowing to manage every situation of fight, even when using low diameter lines with a big fish pulling on the other side. It can be used and actually enjoyed while fishing with the rod always in the hand, thanks to the super balanced and light weight blank. All gui-



des are double leg SiC and the rod's length is adjustable, allowing two length for better fishing action. It features two interchangeable tips of different action.

MEDEA TELEBOAT



This rod feature a blank made from High Resistance Cross Carbon, which make them extremely strong and lightweight, offering an unrivalled progressive action and sensitivity. Medea Teleboat has been made to provide

the maximum control of the fish while fighting. Incredible power in the butt to manage fish even when they are bigger than expected!

SOLARIS

SOLARIS PRO BOAT

Beautiful rod for boat fishing, dedicated to those who look for a value rod that can be used with different techniques. It features a full high modulus CX-1 carbon blank, reinforced by a double wrapping of high resistance carbon to withstand the most severe shocks. Available in sizes of 3 and 3,60 metres, it excels in both bottom and midwater fishing, where you can enjoy its action fighting with mackerel, horse mackerel and chub mackerel. Obviously, this wide range of use, which means that it is possible to fish with leads ranging from 10 to even 200 grams, can be obtained not only through fanatical designing attention, but also through

Code	Length	C. Length	Sections	C.W.	Guide
162-59-300	3.00	112	4+2	200	SiC
162-59-360	3.60	118	5+2	200	SiC



the use of two different action and power fibreglass tips that are provided upon purchase. The handle is non-slip and guides are SiC with double leg. Tips are one legged guided.



SOLARIS SPECIAL PALAMITA



Developed in cooperation with Adriatic sea experts to get the best light drifting rod. You will be impressed by this rod that will allow you to use thinner lines than other rods, thanks to the perfect curve of the high modulus CX-1 carbon blank, which is fully reinforced to grant high resistan-

ce to shocks. Guides have been chosen and positioned according to the

most advanced competition rods: first guide only is double leg. The fibreglass solid tip allows a super sensitivity and great reliability in tough conditions.

Code	Length	C. Length	Sections	C.W.	Guide
162-28-400	4.00	135	6	10-80	SiC



MULTI LENGTH SYSTEM

SENSI TOUCH

2 FLEX XTIP

CROSSED REINFORCED

high precision control

CX-1 CARBON



Supplied with 2 interchangeable tips.

Code	Length	C. Length	Sections	C.W.	Guide
162-30-400	4.00	120	6+2	10-100	SiC
162-30-500	5.00	120	7+2	10-100	SiC

SENSI TOUCH TIP

CROSSED REINFORCED

S.H.M.R. CARBON



Code	Length	C. Length	Sections	C.W.	Guide
162-56-400	4.00	130	5	200	SiC

NEOX

NEW

2000 / 3000 / 4000 / 6000



- Hollow bail with anti twist line roller
- Micro-adjustable drag with oversized washers
- Long Life stainless steel ball bearings
- Infinite anti-reverse
- Power Fight aluminium handle



Find out more on page 157

Saverio Rosa





Saverio Rosa

AEGEAN TELEBOAT

CROSS WINDING SENSi TOUCH 2 FLEX 2XTIP CX-1 CARBON



Supplied with 2 fiberglass tips.

An high grade rod offered at reasonable price, developed for medium-heavy bolentino with 250 grams casting power. With a powerful but progressive action, this rod is particularly suitable for bottom fishing at depths of up to 60 meters. A rod built without any compromise, made from CX-1 carbon and strengthened with the carbon Cross Winding to provide power, balance and sensitivity, everything associated with an exceptional lightweight. The rod is supplied with two tips showing different power, and features salt water proof guides plus non-slip handle.

Code	Length	C. Length	Sections	C.W.	Guide
162-53-320	3.20	115	5+2	250	SiC

NEW DEYLAN MAX DEEP

SENSi TOUCH 2 FLEX 2XTIP CX-1 CARBON MICRO-PITCH



Ergonomic graphite reel seat. Double legs guides with protective O-rings.

The Deylan Max Deep is a telescopic rod with an extremely stiff blank, made from CX1 low resin content carbon, which is perfect for boat fishing in deep water (70-100 m). The whole structure of the blank is able to manage heavy lead, while still keeping high sensitivity. This rod is equipped with 2 fiberglass put in tips (Light and Medium) for use with different weights and making possible to use it for fishing in shallow water too. Double leg stainless steel frame SiC guides and ergonomic graphite reel seat with aluminium hood.



Code	Length	C. Length	Sections	C.W.	Guide
162-62-300	3.00	110	4+2	250	SiC
162-62-340	3.40	110	5+2	250	SiC

NEW DEYLAN SEA POWER

SENSi TOUCH TIPS CX-1 CARBON MICRO-PITCH



Super nice action and greatly handy, the Deylan Sea Power is a telescopic rod for boat deep sea fishing. It can deal with leads up to 400 g and fight good sized preys. The super high modulus CX-1 carbon is very reliable and stiff enough to provide a perfect sensitivity, while the bite detection job is perfectly done by the telescopic solid glass tip. The Trabucco team use this rod for deep sea fishing with live bait or dead natural bait. The double leg SiC guides allow the use of braided lines. Ergonomic graphite reel seat with aluminium hood.



Telescopic solid fiberglass tip.

Code	Length	C. Length	Sections	C.W.	Guide
162-63-300	3.00	115	5	400	SiC

SCUBA BOAT SPECIALIST



Series of stiff and powerful boat rods, very fast when striking into the fish. The telescopic multicolour tip is made from solid fibreglass, super sensitive and able to hinder strong runs in deep waters. It is possible to use these rods with high diameter lines when targeting specimen on wrecks. The high modulus carbon

blank is equipped with SiC double leg guides. You can be sure that a Scuba Boat Specialist will make you able to win the fight with premium fish, without any risk.

Code	Length	C. Length	Sect.	C.W.	Guide
160-19-240	2.40	105	4	120	S-SiC
160-19-280	2.80	105	4	120	S-SiC
160-19-320	3.20	105	5	120	S-SiC

SCUBA TELEBOAT



Series of telescopic rods dedicated to the classic bottom fishing from the boat. They distinguish themselves by a reinforced carbon rigid blank: the stiffness allows easy transmission of vibrations to the hand of anglers who may, in combination with the movements of the multicolor sensitive glass fibre tip, easily identify even the most shy bite of the most wary fish. The blank, thanks to its peculiar architecture of

the sections is able to handle a range of leads from a few up to 150 grams. Double legged SiC guides.

Code	Length	C. Length	Sect.	C.W.	Guide
160-18-210	2.10	96	3	150	SiC
160-18-240	2.40	101	4	150	SiC
160-18-270	2.70	107	4	150	SiC

SEARIDER TELEBOAT



These rods feature a blank made from High Resistance carbon, which makes them extremely strong and lightweight, keeping an unrivalled progressive action and sensitivity. All of these rods have been made to offer the maximum control of the fish while fighting. Incredible power in the butt

to manage fish even when they are bigger than expected!



Code	Length	C. Length	Sect.	C.W.	Guide
160-16-180	1.80	100	3	200	SiC
160-16-210	2.10	100	3	200	SiC
160-16-240	2.40	106	4	200	SiC
160-16-270	2.70	106	4	200	SiC

NEW MAX PLUS SUPER SEA

Sea fishing is tough life for the reel's line, because saltwater and sun light, often particularly strong, aren't keen at all with the polymers which all lines are made from, actually shortening their life length beyond what the other enemies already do: friction through rod's guides, contact with sand and rocks, stress due to heavy leads, damages caused by fish fins. With his new Super Sea, belonging to Max Plus range, Trabucco gives a neat solution to all those problems, at the same time even keeping extraordinary levels of smoothness and softness.

Find out more on page 217



SONIC

The endless list of different coast shapes and natural environments offer fantastic chances to the boat angler, but also causes the need of a vast range of dedicated rods, as tackle should be adapted to depth and sea conditions. For such reason Trabucco continuously develops wide and complete families of rods like Sonic.

NEW SONIC XS TEKNO

The composite fiber blank of the Sonic XS Tekno is well balanced and shows the perfect action to fish for small and medium pelagic, such as mackerel, scad, bogue etc. But the blank is strong enough to fight with bigger predators as bonito and skipjack. The SiC guides feature a corrosion free stainless steel frame.



Code	Length	C. Length	Sections	C.W.	Guide
168-39-180	1,80	92	3	10-100 g	S-SiC
168-39-210	2,10	92	4	10-100 g	S-SiC
168-39-240	2,40	102	4	10-100 g	S-SiC



SONIC XS BOAT



High resistance composite blank rods engineered in short section to be easily stored onboard. Strong blank but still sensitive thanks to the solid fibreglass tip. S-SiC guides can be safely used in combination with braided lines.

Code	Length	C. Length	Sections	C.W.	Guide
168-42-165	1.65	82	3	120	S-SiC
168-42-195	1.95	85	3	120	S-SiC
168-42-225	2.25	85	4	120	S-SiC

SONIC BOLENTINO

The perfect rod for those who start fishing from the boat: versatile and with a really interesting price. The Powerfibre blank is reliable and will absorb most, if not all, the mistakes a beginner can do, while the sensitive tip will make him sure to catch a huge number of species. Braided proof S-SiC guides.

Code	Length	C. Length	Sections	C.W.	Guide
168-43-210	2.10	98	3	120	S-SiC
168-43-240	2.40	102	4	120	S-SiC
168-43-280	2.80	105	4	120	S-SiC



SONIC DEEP MASTER

High resistance composite blank for deep sea fishing. Strong body with sensitive solid fibreglass tip. It will not a surprise if the Sonic Deep Master will help you to catch very big fish from the deep under your boat.

Code	Length	C. Length	Sections	C.W.	Guide
168-40-150	1.50	100	4	150	S-SiC
168-40-180	1.80	100	5	150	S-SiC
168-40-210	2.10	100	5	150	S-SiC

SONIC POWER BOAT

Super powerful telescopic boat rod for fishing on rocky bottoms or wrecks. The Powerfibre blank is strong enough to take away from their homes big congers and fish with the same behaviour. Powerful but still sensitive thanks to the thick solid fibreglass tip.

Code	Length	C. Length	Sections	C.W.	Guide
168-44-240	2.40	100	4	200	S-SiC
168-44-270	2.70	105	5	200	S-SiC



TELE TIP **POWER FIBRE** **HRC**
HIGH RESISTANCE COMPOSITE



Ergonomic graphite screw reel seat with steel moving hood. Telescopic tip, made from solid fibreglass. Butt cap directly screwed into butt section's wall.



SENSI TOUCH **TELE TIP** **POWER FIBRE** **HRC**
HIGH RESISTANCE COMPOSITE



TELE TIP **POWER FIBRE** **HRC**
HIGH RESISTANCE COMPOSITE



SENSI TOUCH **TELE TIP** **POWER FIBRE** **HRC**
HIGH RESISTANCE COMPOSITE



TRITON



TELEBOAT & DEEP SEA

TELE TIP **POWER FIBRE**

Definitely boat fishing is one of the most popular style of fishing, and it is typically done using medium length rods, light but still rigid enough to be able to fight fish that are often of a very interesting sizes. The Triton rods have been created to meet this need about easy to use, effective and affordable rods. The blank is made from Composite Power Fibre and can be used with up to 150 grams lead for the Deep Sea and 200 grams for the Teleboat, both being able to fight and pull big fish from the bottom of the sea, while the top nylon multicolor tip is surprisingly very sensitive and strong at the same time. Triton are equipped with double leg S-SIC guides and non-slip grip butt section.



Code	Length	C. Length	Sect.	C.W.	Guide
160-36-210	2.10	100	3	150	S-SIC
160-36-240	2.40	100	4	150	S-SIC
160-36-270	2.70	100	4	150	S-SIC
160-36-300	3.00	100	5	150	S-SIC



Code	Length	C. Length	Sect.	C.W.	Guide
160-38-210	2.10	101	4	200	S-SIC
160-38-240	2.40	101	4	200	S-SIC
160-38-270	2.70	105	4	200	S-SIC



VEKTOR

Bolentino is surely one of the most antique boat fishing style, well known all over the Mediterranean sea since the stone age, when it was done holding the line over the fore finger to detect the bite. Nowadays, the sport has moved forward with rod and reel, but the vast range of fish species which can be caught is still the same, including sea bream, cod, conger eels in case of bottom fishing, then mackerel, bonitos and blue fish when fishing midwater. The ideal rod? A Vektor by Trabucco, of course!

VEKTOR BOLENTINO



Wide family of rods designed for light, medium and heavy boat fishing. We paid a lot of attention to create these models, in order to get a stiff and reliable blank and a supersensitive action, using a fibreglass tip. The rods are equipped with braided friendly S-SiC guides with stainless steel frame, extremely resistant to salt water.

Code	Length	C. Length	Sections	C.W.	Guide
168-45-150	1.50	75	3	80	S-SiC
168-45-180	1.80	90	3	80	S-SiC
168-45-210	2.10	90	4	80	S-SiC
168-46-150	1.50	75	3	100	S-SiC
168-46-180	1.80	90	3	100	S-SiC
168-46-210	2.10	90	4	100	S-SiC
168-47-150	1.50	75	3	150	S-SiC
168-47-180	1.80	90	3	150	S-SiC
168-47-210	2.10	90	4	150	S-SiC



VEKTOR SARAGO



Complete series of rods for inshore boat fishing with crossing reinforced blank made of powerfibre. Virtually unbreakable, these rods can stand epic fight and efforts. S-SiC guides are saltwater protected and can be used both with monos or braided lines. The high visibility fibreglass tip is ultra sensitive.

Code	Length	C. Length	Sections	C.W.	Guide
168-34-180	1.80	74	4	120	S-SiC
168-34-210	2.10	90	4	120	S-SiC
168-34-240	2.40	90	5	120	S-SiC

NEW Vektor DORADA



This the true classic telescopic boat rod for Mediterranean Sea fishing. Light weight, sturdy and really sensitive, this rod delivers hours and hours of pure fishing fun and still be able to fight against pretty big fish. The butt handle is covered by soft EVA and include a strong screw reel seat. The telescopic tip is made from solid fibreglass to provide sensitivity and strength at the same time.



Code	Length	C. Length	Sections	C.W.	Guide
168-37-180	1.80	63	5	50-150 g	S-SiC
168-37-210	2.10	69	5	50-150 g	S-SiC





NEW TACKLE BOX SYSTEM

Finally everything finds its own place on the boat, thanks to the fantastic Rapture tackle box! Made from stiff plastic material, which is quite strong and resistant to any temperature, this new product allows storing all bits and pieces we need for a fishing session on the boat, which find their safe place in a myriad of adaptable compartments within the three clear drawers with different depth. They are accessible from the front tilt cover, which can become a convenient counter while preparing the rigs. Snelled hooks, ready rigs and sabiki rigs have their own space, with a dedicated shell cover for easy access. All angles are rounded to avoid snagging the line. The sturdy handle folds completely and disappears in the dedicated recess.



Find out more on page 315



CORSARO SPECIALE SGOMBRO



Powerfibre blank new series, powerful and balanced, designed for fishing between surface and bottom targeting mackerels and horse mackerels from the boat. The Corsaro is so sensitive to allow to detect the more tender bite, thanks to the high visibility super sensitive fibreglass tip. It can be used with a wide range of weights, virtually from 10 to 100 gr. S-Sic salt water resistant guides can be used with braided lines.



Code	Length	C. Length	Sect.	C.W.	Guide
168-32-210	2.10	90	3	100	S-SIC
168-32-240	2.40	90	4	100	S-SIC
168-32-270	2.70	100	4	100	S-SIC

NEW CORSARO DEEP SEA



Super strong telescopic boat rod built to last. The extremely stiff blank, made with Powerfibre is able to fight even with big fish and force it out of heavy cover, such as rocks or wrecks. The solid fibreglass tip is sensitive enough to allow you to feel every single bite. All components are salt water resistant.



Code	Length	C. Length	Sect.	C.W.	Guide
168-31-150	1.50	80	3	50-150	S-SIC
168-31-180	1.80	80	3	50-150	S-SIC
168-31-210	2.10	80	4	50-150	S-SIC
168-31-240	2.40	87	4	50-150	S-SIC



BOAT RODS

The rods you'll find in these page are the results of hard engineering work, development and hundreds of hours spent fishing with them. Boat fishing can put under enormous stress a rod and that's why we used just the best materials, reliable and tested again, to be sure that the rods you're going to purchase will never let you down and will last longer.



HERAKLION BOAT POWER

A rod made with the latest generation CX-2 Nano-Tek Carbon further reinforced with Cross Winding System. The blank is ultra-tapered for maximum progress when loaded, while the spigots joints are designed to ensure maximum strength and follow perfectly the rod blank action. All the rods have two fiberglass tips with different power, but are both able to cope with the declared rod weight power, original Fuji salt water proof guides, non-slip handle and stainless steel reel seat Fuji LS. A higher-level tool dedicated to the true experts in the bolentino.



Original Fuji salt water proof guides, stainless steel reel seat Fuji LS.



VANADIA PRO BOAT

A beautiful deep fishing rod medium depth, divided into two sections marked taper, made entirely from high modulus carbon CX-1: an extremely powerful and responsive material. The joint system is very reliable, progressive joint processing eliminates the problem of blocking sections and safeguards the keeping of disconnection. Very stiff and well balanced is characterized by high sensitivity of the two tips provided and for the excellent progress of the blank. Top-level components: "essential" reel seat, Sea Guide Boat rings for maximum performance when using braided lines.



HERAKLION EXTREME DEEP

A super powerful rod made in CX-2 Nano-Tek Carbon. The blank is the perfect synthesis of power and reliability, characterized by extremely progressive action to compensate the powerful counterattack of the big fish that will go to undermine. Heavy duty components, SiC guides (silicon carbide) to allow the use of braided lines. Reel seat is of the type

H-DPS (suitable for electric reels) and is fitted with gimbal cap and first choice EVA handle.

SUPER PROGRESSIVE JOINT

CX-1
CARBON
MICRO-PITCH

Code	Length	C. Length	Sections	C.W.	Guide
161-34-270	2.70	140	2	1000	Boat SiC





Saverio Rosa



Supplied with 2 fiberglass tips.

Code	Length	C. Length	Sections	C.W.	Guide
161-32-300	3.00	175	2+2	300	Fuji
161-32-500	3.00	175	2+2	500	Fuji



Supplied with two high sensitive tips.

Code	Length	C. Length	Sections	C.W.	Guide
161-31-300	3.00	140	2+2	250	Boat SIC





FULGEA DEEP POWER



Boat fishing rods series offered with three interchangeable tips of 100g, 200g, and 300g, all made from solid fibreglass and designed for medium depth fishing. Blank in full CX-1 S.H.R. Carbon, extremely lightweight but strong. Thanks to the Ultra-Conic butt section design it's possible to store the solid tips inside the butt, for a safe and easy transport. The butt section design also helps the overall balance and the rod feel extremely lightweight.

Fulgea Deep Power is also fitted with an ergonomic screw reel seat, saltwater proof components and SiC guides, allowing also the use of braided lines. Available in a range of lengths and actions to cover all needs.



Code	Length	C. Length	Sections	C.W.	Guide
161-27-305	3.00	134	2+3	Max 400	SiC
161-27-335	3.30	149	2+3	Max 400	SiC



EPICA XTREME



Trabucco designed this rod for all the no-limits fishing lovers, a powerful and reliable tool with two spigot jointed sections. It can be used to fish at any depth and is able to face every fish dwelling down there. Perfect for fishing on deep reefs and wrecks, where big congers, groupers and rocklings grow at bigger sizes. It can be used in combination with electric reels as well. SiC salt water protected guides have been chosen for this rod, since heavy fishing is usually combined with braided lines.

Code	Length	C. Length	Sections	C.W.	Guide
161-41-240	2.40	124	2	Max 400	SiC
161-41-270	2.70	140	2	Max 400	SiC

RUSHWAVE XP BOAT



N.F.C. (Nano Fiber Carbon) blank for this allround high performance boat rod showing a beautiful, progressive curve and a significant power reserve in the lower part of the blank. It can be used with great satisfaction both as a trolling rods, 12-20 lbs class, and as a medium/deep sea bottom rod, thanks to the sensitive tip and general light weight. The long tip is directly inserted into the butt section. The prime grade EVA ergonomic handle is equipped with an aluminium reel seat and gimbal. The lowered frame SiC guides allow a safe use of braided lines.

Code	Length	C. Length	Sections	C.W.	Guide
167-48-210	210	170	1+1	300	SiC

SEARIDER BOLENTINO



Series of 2 sections versatile boat rods: true allround models that will fit most of the fishing techniques you can use from your boat. The powerful progressive action blank is just perfect and we are offering two casting weight categories in 4 length. Despite the blank's power, the rod is really sensitive, using a fibreglass tip expertly joined to the rest of the rod. The handle is extremely comfortable and is equipped with an EVA Split handle. The S-SiC guides have a stainless steel frame for salt water use.

Code	Length	C. Length	Sections	C.W.	Guide
161-08-180	1.80	100	2	150	S-SiC
161-08-210	2.10	110	2	150	S-SiC
161-08-240	2.40	130	2	150	S-SiC
161-08-270	2.70	140	2	150	S-SiC
161-09-180	1.80	100	2	200	S-SiC
161-09-210	2.10	110	2	200	S-SiC
161-09-240	2.40	130	2	200	S-SiC
161-09-270	2.70	140	2	200	S-SiC

SEARIDER MAX DEEP



Two sections boat rod, made from Power-fibre and able to stand heavy loads and to properly fish even in deepest waters. The tip is strong and reliable, but still sensitive enough to detect bites down in depth. Despite the powerful blank, the Searider Max deep

is balanced and will not tire angler's arm. S-SiC guides can be safely used in combination with braided lines.

Code	Length	C. Length	Sections	C.W.	Guide
161-18-210	2.10	110	2	200	S-SiC
161-18-240	2.40	130	2	200	S-SiC
161-18-270	2.70	140	2	200	S-SiC

TRITON TEKNO SEA



This is a special series of one piece boat rods built from reinforced Power Fibre. Due to the specific building process, Trabucco succeeded to design a rod that even in 1.20-1.50m delivers the right action and is able to manage at best lures up to 200 g. The Triton Tekno Sea are true salt water rods and are equipped with corrosion free S-SiC braided friendly guides. They are versatile and reliable, and can be used in a number of situations, from classic bottom fishing for different sea bream species to mid water fishing with Sabiki.



Code	Length	C. Length	Sections	C.W.	Guide
165-82-100	1.20	120	1	150	S-SiC
165-82-200	1.50	150	1	150	S-SiC
165-82-300	1.20	120	1	200	S-SiC
165-82-400	1.50	150	1	200	S-SiC

HISASHI HIGH CARBON STEEL HOOKS

Within the worldwide industry of hi-carbon steel hooks, Black Nickel finish is one of the most exciting innovations. Born in Japan to provide hooks destined to saltwater fishing an efficient protection against abrasion and aggressive agents, has been promptly adopted for Hisashi by Trabucco range,

which takes advantage of its capacity to extend point's life.



- Super sharp needle point
- Japan technology



Find out more on page 232

SQUID-EGING & SABIKI

Always at the fore front in new techniques and to help you to improve your catches, here you'll find our latest development about the Eging, Karei and Sabiki fishing.



NEW KAZUMA MASTER SQUID



New family of extremely light and easy to use squid rods for boat fishing. The blank is equipped by a large number of corrosion free guides that helps to transmit vibrations and improve sensitivity. The super sensitive tip can detect with great precision the squid bites. In evidence the 3 pieces configuration which makes these rods so easy to transport and store, plus the butt grip, which is flattened for easy hold within armpit when jigging.

Code	Length	C. Length	Sections	C.W.	Guides
160-84-180	1.80	73	3	100	S-SiC
160-84-210	2.10	86	3	100	S-SiC



KAZUMA MASTER ISO



Based on a parabolic action equipped with many small corrosion free S-SiC guides, these rods are the perfect solution for catching lots of squid. The super slim HVE fibre blank has been specifically designed to manage the typical runs of squids without harming their delicate tentacles.

Code	Length	C. Length	Sections	C.W.	Guides
160-83-180	1.80	100	2	150	S-SiC
160-83-210	2.10	110	2	150	S-SiC
160-83-240	2.40	130	2	150	S-SiC
160-83-270	2.70	140	2	150	S-SiC

The strong graphite reel seat with steel hoods. The butt grip is flattened and carries Kazuma laser engraved logo.



TRITON SQUID STICK

These rods offer a wide casting power range, making them suitable for all the squid fishing techniques. The new Triton Squid are long between 1.65 and 1.80m and have been designed for squid fishing. The HRC blank makes them really comfortable, having a very small butt section diameter. They can be used both with small lures, such as Tatak, and traditional and heavier squid jigs. The super sensitive tip will make the detection of bites far easier.

Code	Length	C. Length	Sections	C.W.	Guides
165-80-100	1.65	111	1+1	10-80	S-SiC
165-80-200	1.80	131	1+1	10-80	S-SiC
165-80-300	1.65	111	1+1	20-100	S-SiC
165-80-400	1.80	131	1+1	20-100	S-SiC



KAZUMA

A new range of eging rods designed for squids and sepias from the boat, featuring extremely light and sensitive blanks.



KAZUMA SPECIAL SQUID

HVE
HIGH VOLUME EPOXY FIBER

Specially developed for Squid fishing, this rod is somehow softer than the Kazuma Master Iso, and is able to manage lures up to 100g. All components are 100% salt water protected, while the blank has been made from High Volume Epoxy Fiber, an high density material which makes it practically unbreakable.

Code	Length	C. Length	Sections	C.W.	Guides
160-90-165	1.65	87	2	100	SiC
160-90-180	1.80	93	2	100	SiC
160-90-210	2.10	110	2	100	SiC

KAZUMA SABIKI

HVE
HIGH VOLUME EPOXY FIBER

Made from full S.H.R. Carbon, the special blank of this rod is extremely strong and fast, but the tip is soft and sensitive, able to detect even the most delicate bite. KAZUMA SABIKI features heavy duty wrapping on guides and salt water proof materials, SiC guides and first choice EVA handle for maximum grip and comfort during the most important fight.

Code	Length	C. Length	Sections	C.W.	Guides
161-07-250	2.50	130	2	100	SiC



NEW SEARIDER MAX SQUID

Squid fishing from the boat is one of the most amusing fishing techniques...and it can provide an excellent food for dinner! The Searider Max Squid is perfect to fish in any condition, even with strong stream, and it can be used with weights up to 150 g. The super sensitive tip can always do the job.

Code	Length	C. Length	Sections	C.W.	Guides
161-19-160	1.60	95	2	150	S-SiC
161-19-180	1.80	100	2	150	S-SiC
161-19-200	2.00	110	2	150	S-SiC

POWER
FIBER



TROLLING

When you are boating on the sea and trolling for big predators you cannot make any compromise, otherwise you risk to miss the fish of your life. Our new trolling rods are born to avoid such serious drawback. Our top of the range families are Windrose Titanium, Windrose Pro Fighter and T-Game, and we believe they will become your best allies in the magic moment when the fish of your life will attack your lure.



Saverio Rosa

NEW T-GAME

XTREME ACTION E-GLASS BLANK

Amongst the Trabucco trolling rods range, the T-game is for sure the most "american" one, both for the components and cosmetic and for the action and consequent class test. The blank is powerful and designed for challenging fishing to fast and pugnacious fish. The 1+1 rods are available in 6' and 6'6" length, all equipped with SeaGuide SiC guides, stainless steel frame. The anodized aluminium reel seat is a reliable model from Pacific Bay, and carries double screw for total safety. The gimbal is made of anodized alluminium too, and is protected by a removable rubber cap.



Offset handle and fore grip are made from EVA. Pacific Bay reel seat.



Sea Guide guides with stainless steel frame and SiC ring.



Slick butt ending with gimbal.

Code	Length	C. Length	Sect.	Power	Guides
167-22-100	6' (1.83)	144	2	12/20	SiC x 8
167-22-200	6' (1.83)	144	2	20/30	SiC x 8
167-22-300	6'6" (1.98)	160	2	8/12	SiC x 9
167-22-400	6'6" (1.98)	160	2	12/20	SiC x 9
167-22-500	6'6" (1.98)	160	2	20/30	SiC x 9

SEALION OB



8+2
SS SHIELDED BALL BEARING

Sealion OB is a reliable series of trolling reels developed for all those sea anglers who refuse to accept any compromise on quality of their own tackle.

Find out more on page 191

WINDROSE

The trolling rods Wind Rose Pro-Fighter series are made for those experts who demand a concentration of technology and expertise to their equipments.

WINDROSE TITANIUM

XTREME ACTION **NFC**
NANO FIBER CARBON

A trolling rods series, dedicated to the hi-tech trolling world, following the requirements of the new saltwater fishing techniques. The superb parabolic action with the ultra fine blank helps to boat the fish in every situation. Built entirely by Nano Carbon Fiber with a Magic Stick technology which ensures sensitivity and durability, the WINDROSE TITANIUM is extremely light and strong; the special SiC guide

assembly helps it to be a very innovative rod. A series of rods of the highest quality multi-purpose properties that make them suitable for a different fishing style as: the downrigger, live bait and guardian triggering. Aluminium reel seat and removable butt represents unrivalled value for money.

CARATTERISTICHE TECNICHE:



The aluminium gimbal butt, the offset slick butt and quality aluminium ALPS reel seat further enrich this rod, which is surely destined to offer great performances.

All rods are fitted with Sea Guide SiC double wrapped guides, perfectly suitable for braided line use.



Code	Length	C. Length	Sections	Power	Guides
167-26-120	1.95	1.64	1+1	8-12lb	SiC x 8
167-26-200	1.95	1.64	1+1	12-20lb	SiC x 8
167-26-300	1.95	1.64	1+1	20-30lb	SiC x 8
167-26-400	2.10	1.79	1+1	12-20lb	SiC x 8
167-26-500	2.10	1.79	1+1	20-30lb	SiC x 8

WINDROSE PRO FIGHTER

XTREME ACTION



The Wind Rose Pro-Fighter series are made for those experts who demand a concentration of technology and expertise to their equipments. This series of perfect war instruments is presented to the angler in five versions to have the right rod for every situation. Built thanks to an innovative formula of composite material, the PRO FIGHTER Series combines progressive parabolic action, power and lightness. All five models are fitted with SiC guides, so they can be used with braided lines. The series is offered with special guide assembly designed by our experts to increase the already high reserve of power that distinguishes these rods. The aluminium gimbal cup enriches the product for great performance.

Two 6 feet PRO FIGHTER are dedicated to those who want a high performance stand-up. Perfect for fishing with the downrigger (sunk), the pro-fighter 6-foot turn out amazingly handy, and, at the same time, secure and powerful in dealing with the most challenging fights with big amberjack, snapper and grouper. Three 7 feet extremely light and sensitive are specially designed for lead guard fishing style. With their low weight and ergonomic grips, these rods can also be used for fishing with rod in the hand.



Code	Length	C. Length	Sections	Power	Guides
167-27-120	1.80	1.49	1+1	12-20lb	SiC x 7
167-27-130	1.80	1.49	1+1	20-30lb	SiC x 7
167-27-212	2.10	1.64	1+1	8-12lb	SiC x 9
167-27-220	2.10	1.64	1+1	12-20lb	SiC x 9
167-27-230	2.10	1.64	1+1	20-30lb	SiC x 9



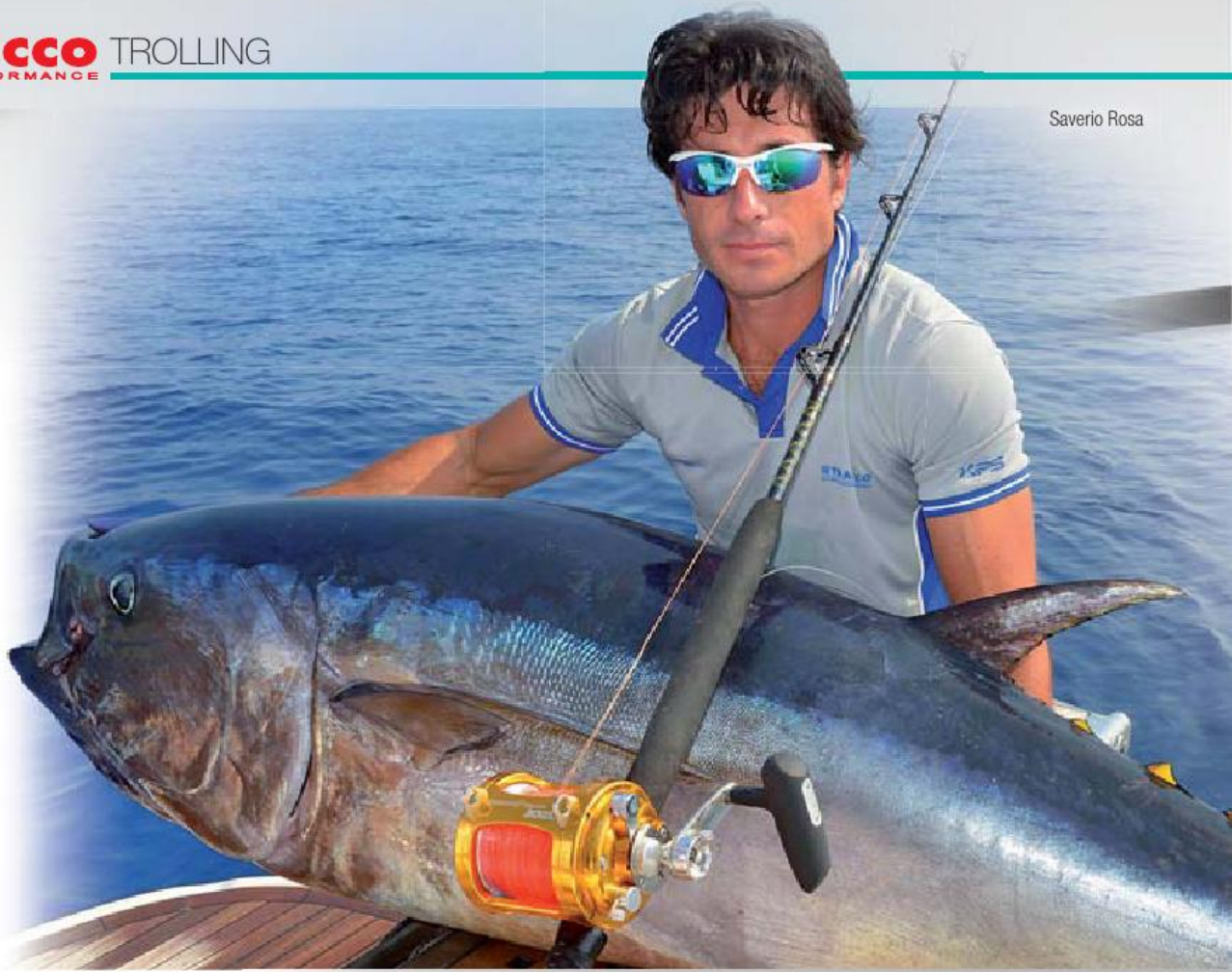

BIG GAME

XTREME ACTION



The Trabucco team of engineers designed this rod for heavy trolling. Blank is made from solid E-Glass, the best solution when you come to true fighting rods, with a fantastic parabolic action able to face with big pelagic predators. The range is wide, 3 models to cover all needs, and all models are equipped with roller guides. The Big game rods are suitable both for fast surface trolling and bluefin tuna drifting. Every roller is fixed to the blank with under wrapping to preserve it from breakage risk even during maximum

efforts. These rods feature aluminium reel seat, gimbal and slick butt handle.

Code	Length	C. Length	Sect.	Power	Guides
167-24-050	1.65	165	1	20/50lb	TRG X6
167-24-080	1.65	165	1	30/80lb	TRG X6
167-24-100	1.65	165	1	50/100lb	TRG X6



SEAWOLF GOLD

Trabucco is the official distributor of the trolling and vertical jigging Maxel reels on Italian market.



Total reliability and strength are the two main targets which have driven the development and production of these reels, along with unique design, precision engineering and totally saltwater proof materials. Each single component has been created to give the best performance, being able to deal with the fastest runs of big sea fish.



Find out more at page 190

RUSHWAVE



RUSHWAVE STRIKER

XTRME ACTION **NFC**
NANO FIBER CARBON

A 2,10 meters rod dedicated to the trolling angler that likes to have onboard a high specification rod with medium progressive action and with an excellent power reserve. Designed by our experts for down rigger trolling with livebait, this rod is perfect for trolling with mullet, cuttlefish, squid or horse mackerel. It is equipped with an aluminium gimbal resistant to corrosion for durability and better fighting comfort. Despite the slim blank, the Rushwave is able to safely manage big fish like amberjack, grey snapper and

groupers, thanks to the Nano Fiber Carbon construction and double leg low profile SiC guides.



Code	Length	C. Length	Sections	Power	Guides
167-44-210	2.10	115	2	12-20lb	SiC x 9

RUSHWAVE POWER STICK

XTRME ACTION

CARATTERISTICHE TECNICHE:



Usually light weight and power are specifications which can't live together in the same rod. But the new Rush Wave Power Stick, built from hollow E-Glass, succeeds to wonderfully combine them. The lighter models are just perfect for live bait trolling, using small diameter braided lines. This combination will allow to fish for snappers on rocky habitats. The 50 lbs version features a starting and top roller, to minimize line stress during strong fights with big fish. SiC guides are the correct complement and are suitable for braided lines. Every guide or roller is also under wrapped to protect the blank when it's extremely bent. Aluminium gimbal butt.



Code	Length	C. Length	Sections	Power	Guides
167-46-012	1.80	145	1+1	12lb	SiC x 7
167-46-020	1.80	145	1+1	20lb	SiC x 7
167-46-030	1.80	145	1+1	30lb	SiC x 7
167-46-050	1.80	145	1+1	50lb	SiC+TRG x 7



ARUBA TROLLING



Owning a Travel trolling rod which has a total length of 215 cm with a one section rod action has always been the dream of every fisherman. Finally, thanks to careful design of the Trabucco's engineers, everything is now possible. With NFC technology (Nano Carbon Fiber), it has been possible to obtain a 5 sections rod with spigot joints which has a parabolic and progressive action subject of such power that rivals the more famous one-piece currently available in the market. Offering 20-30 lbs test curve, is extremely versatile for a trolling technique, ranging from lead guard, down rigger and live bait surface trolling. Comfort and technology for a rod that can not miss in any traveller's luggage. Supplied with a stiff cordura tube for safe transportation.



Code	Length	C. Length	Sections	Power	Guides
167-31-100	2.15	52	6	20-30lb	Sic x 10

SKIPJACK



Skipjack has been designed to satisfy the highly-demanding anglers who look for a stand-up rod with the sensitivity of a standard long trolling model. With the size slightly longer than normal stand-ups and their special blank construction, these rods perfectly combine the best of both worlds. Sensitive tip, length around 170 cm and powerful back bone are the winning details of this multi-purpose rod series. The 6-12, 12-20 and 20-30 lbs rods, structured with hollow blank and carrying SIC guides, are suggested for live bait surface trolling to catch bluefish and snappers.

MERIDIAN FIGHTER STAND UP



The Trabucco Meridian series is made of composite super durable and reliable E-Glass, finished according to the method of superimposed layers to get an action equivalent to that of a much higher priced rod. It is therefore a very funny rods which leaves space to the fight with the fish, while maintaining an exceptional reserve of power in the lower part of the blank. The series includes 6 actions to cover at their best different fishing conditions, from mackerel to bonito, from dolphin fish to his majesty the bluefin tuna.

The first two rods of the series, 12-16lb and 16-20lb, have been fitted with HD salt water resistant S-SIC guides. The next two actions 20-30 and 30-50 lbs fit a TRG HD roller on top for better management of large diameter's nylon and also features a reinforced safety reel seat. Finally the 50-80 lbs, designed for bluefin tuna fishing, carries two TRG HD rollers (the first and the last) to cover the points of greatest friction, and a reinforced safety reel seat. The price will surprise you.

XTREME ACTION **NFC**
NANO FIBER CARBON

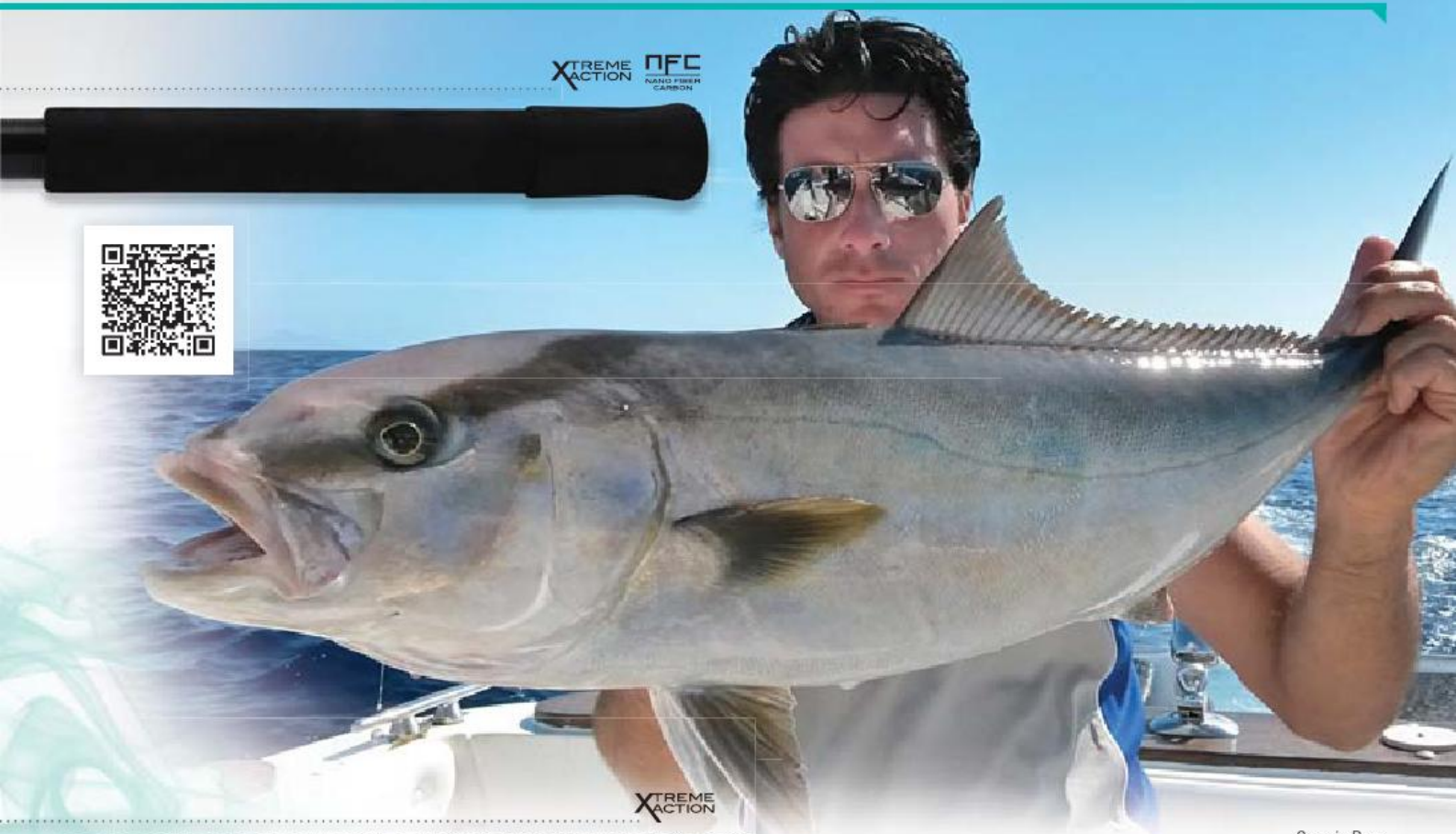

XTREME ACTION

Saverio Rosa



The 30-50 lbs rod has a solid blank and full rollers to face long and tough fighting with giant tuna.

Code	Length	C. Length	Sections	Power	Guides
167-39-012	1.65	165	1	6/12lb	SiC x 7
167-39-120	1.65	165	1	12/20lb	SiC x 7
167-39-130	1.65	165	1	20/30lb	SiC x 7
167-39-150	1.65	165	1	30/50lb	TRG x 5

XTREME ACTION **E-GLASS**
BLANK



Code	Length	C. Length	Sections	Power	Guides
167-41-012	1.65	165	1	8/12lb	SiC x 8
167-41-016	1.65	165	1	12/16lb	SiC x 8
167-41-020	1.65	165	1	16/20lb	SiC x 8
167-41-030	1.65	165	1	20/30lb	SiC+TRG x 8
167-41-050	1.65	165	1	30/50lb	SiC+TRG x 7
167-41-080	1.65	165	1	50/80lb	SiC+TRG x 7

MERIDIAN GT

3+1
SS SHIELDED
BALL BEARING



- Graphite body is salt water resistant
- Side plates are reinforced by a stainless steel ring, to strengthen the whole chassis.
- The smooth drag has a Max Drag of 20 lbs and can be set up very carefully.

Specially designed for trolling in the Mediterranean sea, which has a higher salinity ratio compared to the oceans, this multiplier is fully protected from saltwater corrosion and fits stainless steel ball bearings with double side shield. Offering a powerful star drag system plus fighting handle knob, it has no levelwind and it's compatible with braided lines.

Scopri di più a pag. 193



Saverio Rosa

NEW TSUNAMI TROLLING

XTREME ACTION

Stand-up series of rods with fast action. The family is made of 2 models of 6'6 and 2 of 7', very good for trolling with live bait close to the bottom. The ergonomic handle allows to apply all the cranking power to the rod and reel complex, exploiting all the force of the angler. The reels seat and the gimbal are made from extra stiff graphite. The reliable and light weight blank is just perfect for Mediterranean Sea trolling.



Thanks to the special frame shape, guides and top guide are amazingly strong. Double wrappings.



Strong reel seat made from graphite and steel, fitted upside down for extreme strength.

Code	Length	C. Length	Sections	Power	Guides
167-38-130	6'6" (1.98)	165	1+1	12/30	S-SiC x 8
167-38-140	6'6" (1.98)	165	1+1	15/40	S-SiC x 8
167-38-230	7' (2.10)	175	1+1	12/30	S-SiC x 8
167-38-240	7' (2.10)	175	1+1	15/40	S-SiC x 8

NEW TRIDENT TROLLING

XTREME ACTION



Gimbal butt with tailor made rubber cap.

Small family of two 1+1 rods with an extremely amusing action, thank to a blank that allows a sporting and sensitive fight with the fish. The tip of this rod, made from solid fiberglass, matches perfectly with the rest of the blank, and this is the secret of the nice combination between sensitivity and strength of the whole rod. The Trident rod is the one that everybody would like to have to practice inshore trolling for bonito and other predators. Reel seat and gimbal made from hard graphite. Heavy duty stainless steel SiC guides can be used with braided lines, and are fixed by double wrapping.

Code	Length	C. Length	Sections	Power	Guides
167-34-112	6' (1.83)	150	1+1	6/12	S-SiC x 8
167-34-120	6' (1.83)	150	1+1	12/20	S-SiC x 8
167-34-130	6' (1.83)	150	1+1	20/30	S-SiC x 8

NEPTUNE

NEPTUNE TROLLING

XTRME ACTION

New series dedicated to small and medium coastal trolling. This rod has a very amusing parabolic action, able to satisfy those anglers who like to have more contact with the prey and then derive more satisfaction.



On the other hand such an action allows to face fights with greater security and because of the perfect curve of the blank it is possible to fight fish even larger than the power of the blank would let you imagine. Despite the affordable price, the Neptune Trolling maintain high quality standards, such as the aluminium gimbal and braided-proof guides with under wrappings. Such details are unmatched in rods with similar price range!

Code	Length	C. Length	Sections	Power	Guides
167-33-112	1.80	180	1	6/12lb	S-SiC x 7
167-33-120	1.80	180	1	12/20lb	S-SiC x 7
167-33-130	1.80	180	1	20/30lb	S-SiC x 7

NEPTUNE MARINER

XTRME ACTION E-GLASS BLANK

Series of hybrid rods, suitable both for heavy bottom fishing and trolling, and able to face epic fights with really big fish. To highlight this double use, Trabucco printed on blank both trolling power and casting weight. The 180 cm blank is built in one piece and each guide has been wrapped and under wrapped

for increased safety. Neptune Marine rods feature DPS reel seat and braided-proof guides.



Code	Length	C. Length	Sections	Power	Guides
167-36-020	1.80	180	1	12/20lb	S-SiC x 6
167-36-030	1.80	180	1	20/30lb	S-SiC x 6

NEPTUNE SR

- All the gears are salt water treated and perform a 3.8:1 gear ratio, the correct compromise between speed and power.
- Both sizes feature level wind for an easy use and perfect line lay.
- Graphite body is light weight and corrosion resistant.

Very simple and easy to use, reliable and durable. In a few words the complete description of these good multipliers by Trabucco. The gear ratio, which is relatively low, enables the reel to develop high retrieving power, while the levelwind assists the newcomer and the occasional user. Perfect to match the Neptune trolling rods, these reels are particularly elegant and offer a total protection against saltwater.



Find more at page 193



HOBBY

When fishing is pure pleasure, what counts is to get fun without investing a fortune. So one of these reliable rods is more than enough: just

add a Trabucco reel, some good advice from the retailer and... go fishing!

NEW ACCORD BOLO



A bolognese rod to be stored in the car's booth, ready to face any event, including the injuries the children will reserve it. The Accord is a simple and reliable rod, which just needs one

of those pre-spoiled Auris or Regent Trabucco reel to make everybody happy.

Code	Length	C. Length	Sections	Guides
163-74-300	3.00	115	3	S-SiC
163-74-400	4.00	115	4	S-SiC
163-74-500	5.00	115	5	S-SiC

Code	Length	C. Length	Sections	Guides
163-73-300	3.00	115	3	-
163-73-400	4.00	115	4	-
163-73-500	5.00	115	5	-
163-73-600	6.00	115	6	-

EXPANDER BOLO



Telescopic rods with small closed length, made in Powerfibre. Strong and reliable, these cheap tools are ideal for to get started in the fascinating world of fishing in fresh and salt waters.

Code	Length	C. Length	Sections	Guides
163-72-300	3.00	115	3	S-SiC
163-72-400	4.00	115	4	S-SiC
163-72-500	5.00	115	5	S-SiC
163-72-600	6.00	115	6	S-SiC

DEMON CARP TELE



Three different sizes for this telescopic rod series. Extremely strong thanks to the Powerfibre construction, they can be used with big sized elastic. These rods are made for all the people who love margin fishing in carp fisheries, available in size 1.80, 2.40 and 3.00m.

Codice	Lunghezza	Ingombro	Sezioni
163-31-180	1.80	67	3
163-31-240	2.40	67	4
163-31-300	3.00	67	5

DEMON CARP MARGIN POLE



Series of short margin pole designed for heavily stocked carp fisheries. The blank is extremely strong and totally reliable thanks to the full Power Glass construction, this allows big sized elastics to be used to fight even the toughest fish.

Code	Length	C. Length	Sections
163-33-300	3.00	120	3
163-33-400	4.00	120	4

DEMON FEEDER



HRC
HIGH RESISTANCE COMPOSITE

The Demon Series has been designed for feeder fishing in lake, canal or river. The super resistant blank is made of HRC, a light weight and reliable composite material. Every model is equipped with two tips, both with the same action but having different power. The rods features S-SiC guides, really useful to disperse heat during prolonged fights.

Code	Model	Length	C. Length	Sct	Action	C.W.	Guides
163-25-330	Carp	3.30	116	3+2	MH	90	S-SiC
163-25-360	Carp	3.60	126	3+2	MH	90	S-SiC
163-26-360	Power	3.60	126	3+2	H	120	S-SiC
163-26-390	Power	3.90	136	3+2	H	120	S-SiC
163-27-360	River	3.60	126	3+2	HH	150	S-SiC
163-27-390	River	3.90	136	3+2	HH	150	S-SiC

NEW POWER TELE



A comprehensive range of telescopic rods destined to bottom fishing with leads ranging from 120 to 200 grams weight, both in fresh and saltwater. Made from Powerfibre to grant strength and durability, they fit metal frame guides and screw reel seat with steel hoods. Yellow, green and orange colour help to identify their casting weight. The closed length is quite short to ease the transport.

Code	Model	Length	C. Length	C.W.	Sect.	Guides
165-70-120	Green Power	3.60	110	120	4	S-SiC
165-70-125	Green Power	3.90	110	120	4	S-SiC
165-70-160	Yellow Power	3.60	110	150	4	S-SiC
165-70-165	Yellow Power	3.90	110	150	4	S-SiC
165-70-200	Orange Power	3.60	110	200	4	S-SiC
165-70-205	Orange Power	3.9	110	200	4	S-SiC

REVENGE WRC



Series of telescopic rods extremely durable and reliable, made of Powerfibre, powerful but lightweight material. They are equipped with S-SiC guides and sliding guides, plus shock absorber reel seat.

Code	Model	Length	C. Length	Sections	Guides
165-40-300	Seabass 120	3.00	107	4	S-SiC
165-40-350	Seabass 120	3.50	107	4	S-SiC
165-41-300	Seabream 150	3.00	107	4	S-SiC
165-41-350	Seabream 150	3.50	107	4	S-SiC

Code	Model	Length	C. Length	Sections	Guides
165-42-300	Saragus 200	3.00	107	4	S-SiC
165-42-350	Saragus 200	3.50	107	4	S-SiC
165-43-300	Carp 150	3.00	107	4	S-SiC
165-43-350	Carp 150	3.50	107	4	S-SiC

REVENGE WRC SPIN



Very light but actually unbreakables, these 2-section rods are able to satisfy the newbies of predator fishing with very good actions. The PW (Power) versions are much more powerful and dedicated to salt water and silure fishing. The S-SiC guides allow the use of braided lines.

Code	Model	Length	C. Length	Sections	Guides
163-43-240	2.40	126	2	80	S-SiC
163-43-270	2.70	141	2	80	S-SiC

Code	Length	C. Length	Sections	C.W.	Guides
163-42-210	2.10	111	2	30	S-SiC
163-42-215	2.10	111	2	45	S-SiC
163-42-240	2.40	126	2	30	S-SiC
163-42-243	2.40	126	2	45	S-SiC
163-42-245	2.40	126	2	60	S-SiC
163-42-270	2.70	141	2	30	S-SiC
163-42-273	2.70	141	2	45	S-SiC
163-42-275	2.70	141	2	60	S-SiC

HRC
HIGH RESISTANCE COMPOSITE

TRABUCCO REELS: TECHNOLOGY AND DESIGN

The new Trabucco reel's collection include some real jewels from mechanical point of view, with metal bodies highlighting the hi range models on performance side, plus some interesting innovations which are destined to draw the attention. As always, we have spent our best energies to care about design, because we believe that fishing tackle shouldn't just have an utility, but should also be nice. After all, we are Italians, and would like the world to notice it!



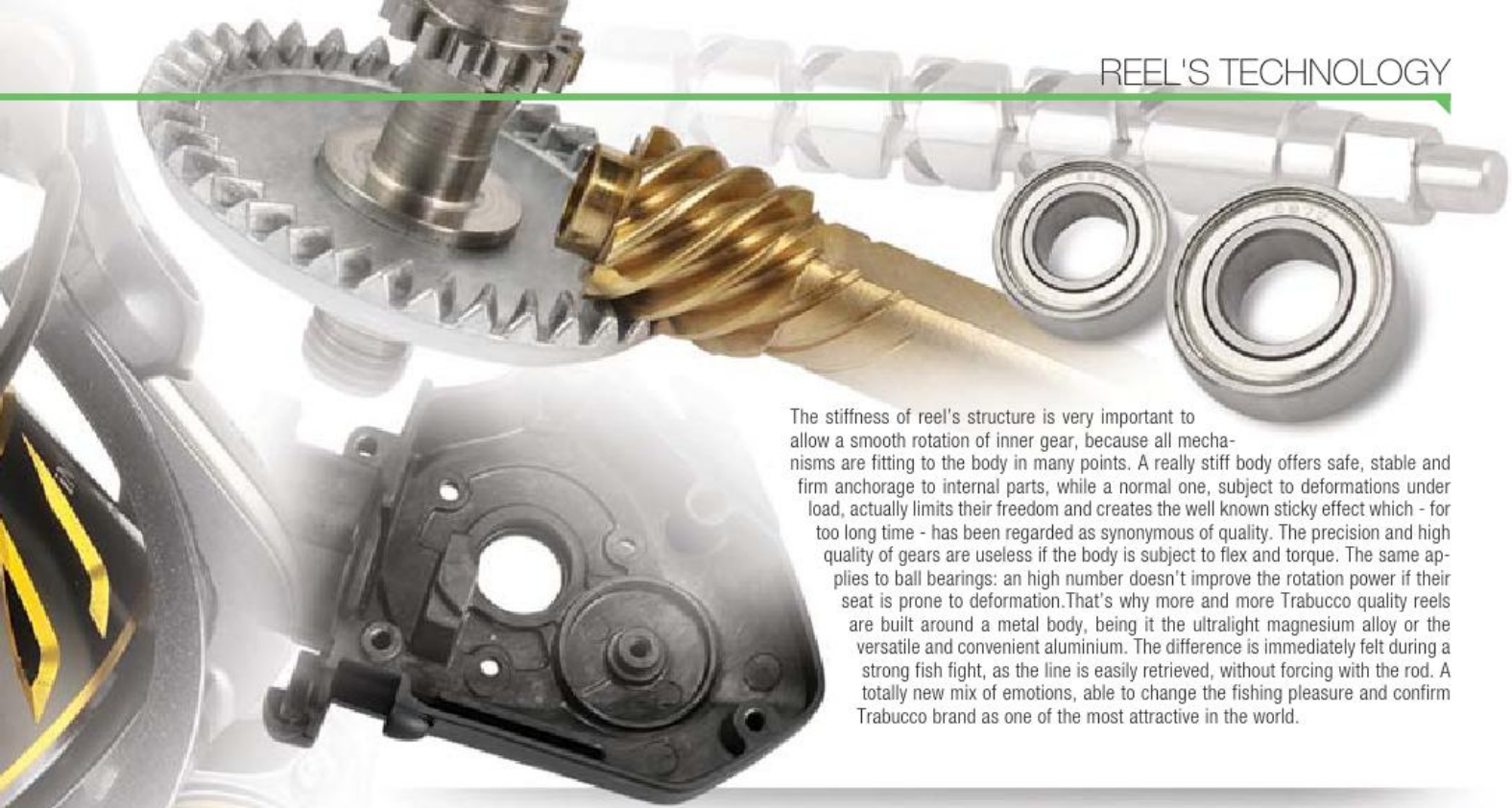

The stiffness of reel's structure is very important to allow a smooth rotation of inner gear, because all mechanisms are fitting to the body in many points. A really stiff body offers safe, stable and firm anchorage to internal parts, while a normal one, subject to deformations under load, actually limits their freedom and creates the well known sticky effect which - for too long time - has been regarded as synonymous of quality. The precision and high quality of gears are useless if the body is subject to flex and torque. The same applies to ball bearings: an high number doesn't improve the rotation power if their seat is prone to deformation. That's why more and more Trabucco quality reels are built around a metal body, being it the ultralight magnesium alloy or the versatile and convenient aluminium. The difference is immediately felt during a strong fish fight, as the line is easily retrieved, without forcing with the rod. A totally new mix of emotions, able to change the fishing pleasure and confirm Trabucco brand as one of the most attractive in the world.

THE BODY



Body and rotor fully made of premium quality metal alloys, built to withstand the most challenging situations and to last in time. This technology belongs to top range reels only.



With a specific gravity 20% lower than aluminium and an even higher stiffness, the Magnesium alloy is definitely the most advanced material to produce reel's bodies. Great fashion, but also great performances.



Innovative technology that allowed us to produce fully Carbon Body and rotor, the top you can get in terms of lightness and still able to grant a great resistance to mechanical stress. As per the Metal Body this technology has been used for top range reel only.



Hybrid Body means a body made of aluminium and graphite. The aluminium has the task to withstand the mechanical stress, while the graphite helps to keep the weight as light as possible. Hybrid Body reels can grant you to fish safely and with light equipment.



Innovative material added of uni directional Carbon micro fibres. This technology is the ideal combination between light weight and stiffness. It is naturally corrosion free and we use this material for high performance reels only.



It is the more common material used in the fishing tackle industry for reel building: light weight and reliable. It is anyway a very important step to add an appropriate structural development to get outstanding performance from it. Only a few companies can do it properly.

THE GEARS



GEAR RATIO. The Gear Ratio defines the number of rotor's turns for each complete revolution of the handle, therefore the number of turns of mainline that are wrapped in a spool at each turn of the handle. Higher is the first number, faster the reel will turn and consequently greater is the amount of lines recovered for each complete revolution of the handle. We recommend fast reels for long-casting fishing techniques where you need to cast and retrieve more often, while slower models come into play when you need high recovery power.

LONG LIFE GEAR

We have to talk about raw materials and in particular metals, because these are at the heart of all the gears. Durability and performance of derive mainly from the quality of the materials involved in the construction of pinions, gears and bearings... for these mechanical parts Trabucco uses only the best quality materials such as bronze and steel... we don't use other materials because only these can provide the reliability standard and resistance that our customers deserve.



BALL BEARING SYSTEM. A well designed mechanic uses only high quality ball bearings to improve the gears motion. The BBS indication on each product, provides the number of the bearings used on the reel. The first figure is the quantity of the ball bearings used, whilst the second is the number of the roller bearing. The roller bearing is one-way only, and it's positioned on the central pinion to force the rotation and prevents the reels from the even the smallest back turn, also known as the "One way clutch". The ball bearings reduce friction of moving parts and the more there are, the better the mechanics work.

PG (PRECISION GEAR)

Are the basis of the mechanical function of our reels. The fluidity and smoothness of rotation that Precision Gears provide is responsible for the speed and above all of the power of the reel. The rotors and the gears of our reels featuring the PG technology are designed using the latest 3D software, thus to guarantee the perfect assembly of every single part to improve efficiency and reduce friction.

After so many years from the date we started to sell our first models, we are still engaged into design and development like it was the very first day. The many innovations that you will find in the new models are the result of assiduous research done on the main characteristics that must have a perfect reel. Our aim is to offer you products that stand out from the crowd for their reliability and performance.

LINE MANAGEMENT SYSTEM

WORM SHAFT GEAR WSG

WORM SHAFT GEAR. The worm gear is a double groove engraved into a pinion. In this way the traction is carried with uniformity, reducing friction and giving a smoother retrieve. The Worm Shaft Gear is also reducing line tension, responsible of the oscillations of the spool and so the line winding is perfect.

SOS SLOW OSCILLATION SYSTEM

SLOW OSCILLATION SYSTEM. It is the most evolved line laying system. During the retrieve action the SOS slow down the spool oscillation movement in regard to rotor speed, allowing a more accurate and compact line lay. Looking carefully at the spool you will notice a different speed going from bottom to top and vice versa. This technology, applied on top range reels, always grant a perfect line lay and avoid line wigs when castings.

CW CROSS WINDER

CROSS WINDER. To those fishermen who do not have a complete experience of the art of fishing, which use either mono or braided lines, we recommend to buy a reel with the "cross winder" line spooling system, instead of a reel with the most performing WSG. The spooling is very tidy with Cross Winder, provides good casting distances and reduces the possibility of tangles. The "X" spooling in fact compact lines and allows a best spooling even with lower tensioned mainline.

AS ROLLER ANTITWIST SYSTEM

ANTITWIST SYSTEM. Traditional line rollers force tension on to the line at every turn of the handle and this can cause line tangles. All our reels nowadays are fitted with the new Anti twist line roller together with WSG and SOS systems to avoid this problem and also extending the life of even the lightest of the monofilaments.

POWERBAIL

TUBULAR BAIL. In several models, we introduced a aluminum tubular bail that is larger than traditional ones. Although larger, these new bails are lighter and more durable than traditional. Due to their special shape and the innovative conical joint, they drive automatically monofilament inside the line roller even when the nylon is not perfectly under tension.

ROTOR STOP SYSTEM

Even in the highest quality reels sometimes during the cast the bail arm can accidentally close. With this new locking system, fitted onto the rotor, this risk has been almost completely eliminated. The angler is advised by an audible click that the bail arm is locked correctly.

VIBRATION DAMPER

AVS ANTI VIBRO SYSTEM

ANTI VIBRO SYSTEM. We asked our designers the challenge to minimize or even cancel the vibrations emitted by reels during the recovery phase. Thanks to the new 3D software, they have been able to design well balanced rotors (Super Balance System) but for top range reels we wanted something more. We focused on the stabilization of the gears and the subsequent cancellation of the games that swing the spool. The result is excellent, the pinion holds the spool firmly on its axis and this does not oscillate even when drag is in traction. We are particularly pleased with the results ... You just have to try.

SBS Super Balance System

SUPER BALANCE SYSTEM. This new technology is obtained just using the latest computers 3D softwares, which allows the designing and later the construction of perfectly balanced rotors without the addition of external weights. The resulting balance reduces any vibrations of the reel during the recovery. All our reels are designed using these softwares and deeply tested before the production, and you'll find at least the SBS system across the whole range.

ANTIREVERSE SYSTEM

ONE WAY CLUTCH

ONE WAY CLUTCH (INFINITE ANTI-REVERSE). Anti-reverse system in use in most of our reels. Thanks to a lever usually located above or below reel body you can plug or unplug the operation of the one-way roller bearing that holds the main shaft and provides an excellent infinite anti-reverse performance, with our One-Way Clutch system you'll find absolutely zero free-play on the handle.

MULTI STOP SYSTEM

MULTI STOP SYSTEM (ANTI-REVERSE). On reel that's not possible to fit the infinite antireverse and therefore is not used the one-way roller bearing, we have designed an effective alternative system to block the rotor motion. The Multi Stop System slows down the rotor sequentially in several key points when rotates in the opposite direction to that of the line winding.

SEA FISHING TECHNOLOGIES

SWR SALT WATER RESISTANT

SWR (SALT WATER RESISTANCE). A construction technology applied to the reels dedicated to saltwater fishing and who affects all the metal parts (making them unassailable by salt, UV and temperature), all the seals (to prevent the sea water comes into contact with the mechanics, with special O-ring were sealed all possible splits), and even the mechanical parts (suitably enhanced depending on the type of prey that you want to capture and type of technique fishing must be adopted).

DRAG SYSTEM

MICROMETRIC DRAG

The drag is a device whose operation depends from the friction generated by mechanical rubbing between the brake washers that make up the brake system. The drag power is determined by the number of the washers, their diameter and the material they are made. Its power is directly proportional to the number of washers and their diameter. The most used washers on our range are made PTFE coated (felt discs in PTFE based oil bath), while the more expensive reels feature carbon cloth washers, that provides even higher performance. The drag quality is primarily determined by its smoothness, drag must operate smoothly even under high pressure. Another point is the micro adjusting, which means that to each click of the knob must be corresponding into a micro increase or decrease of the power. The Trabucco reels stand out because of the high drag power and the excellent progression of the drag.

FAST PLAY DRAG

Brand new drag system featuring a dual-presetting mode that incorporates in one single device all the free runner drag facilities. It acts directly into the spool, allowing to have a more direct, progressive and fine tuning drag system. The free spool setting is regulated by the inner knob, while to switch to the combat drag is enough to half turning the main drag knob.

FREE RUNNER

When this device entered carp fishing with such force it revolutionised the sport to such an extent it became essential. It is now also much favoured in other freshwater and saltwater applications. The free runner lever situated on the back of the body allows the angler to switch from the pre-tensioned drag for fish playing to the "free" position, and back again easily. On our reels all the Free Runner reels features oversized washers to always guarantee a good control and smoothness.

MAX DRAG (DRAG BRAKING POWER)

Only in the Top Range reels, the most expensive and mainly dedicated to the sea fishing, which shows the MAX DRAG power. Carefully measured and expressed in kgs, the real drag power is calculated during the traction with disks fully engaged. Warning, drag must operate during the calculation of the Max Drag, if the disks are blocked the Max Drag increases, but the drag is not working properly and the measurement is invalid. For Trabucco Max Drag means real drag braking power.

LINE'S MANAGEMENT



V-SPOOL DESIGN. The V-Spool Design spools reduce the friction between the line and the lip during the cast, reducing the number and the diameter of the coming out coils and thus reducing dramatically the risks of tangles when using braided lines. The lower friction make your casts longer and more accurate too, improving your fishing experience and extending the life of your spooled line.



CNC MACHINE CUT ALUMINIUM SPOOL. Top range reels feature spools tooled "bleed" from one piece of solid aluminum. The CNC machine lathe ensures a complete perfection of shape, the maximum smoothness of the line during casting, exceptional tensile strength, pressure and any other force exerted. CNC aluminum spool are extremely lightweight but yet offer the highest structural resistance to impact and abrasion.



SUPERLIGHT SPOOLS. On medium range reels, just to contain the final cost, we preferred to fit graphite spool instead of the metal. The graphite is a rugged and lightweight material, it is often used for the construction of the reels bodies and thanks for his technical / structural well-suited features is perfect for the construction of the spools. The reels have been equipped with a graphite spool are marked on the box with Superlight logo.



SPARE SPOOLS. Trabucco gives you the chance to duplicate and even triplicate the spools of the reel you have purchased. Many of our models have one or more spare spools in order to give the buyer the opportunity to load lines of different diameters, or braided or nylon. By doing so you can fish with a single reel in many ways or with different techniques. The number shown in the logo indicates the number of spare spools the reel comes with.



SWT (SALT WATER TREATED). The SWT (Salt Water Treated) is a recent manufacturing process, less efficient if compared to the SWR but still allowing using the reel in salt water for a long time without any corrosion risk. Under strong loads and in tough conditions, typical of salt water game, the SWT does not add any weight to the whole reel. This new manufacturing process is using special hi tech varnishes and it used on all the parts sensible to salt, making them even harder. In a nut shell this procedure will not only make your reel salt water resistant but just more resistant to all solicitations.

INVICTUS

ENJOY THE POWER OF TECHNOLOGY

Advanced metal alloys and high modulus carbon: only handle's knob is made from traditional material! But high grade materials can do little if there isn't the right technology to draw the best from them, and in this case plenty of it has been employed. Just a couple of handle turns, with a fighting beast at the other end of your line, will let you feel the extreme power which is hidden inside your Invictus.



The spool's lip is remarkably thin and "V" shaped to minimize line friction during the cast and to increase distances and accuracy (V Spool Design).



The line roller is designed to avoid line torque at each handle's turn, so that line will flow smoothly and last longer (Anti Twist System).



The ultra-thin grooves we can see through a lens prove that the spool has actually been machined from a solid piece of aluminium for higher strength.



NEW INVICTUS

The Invictus reel is just the last in time of this state of the art projects and is featuring many technological innovations. The hybrid structure is made of aluminium and graphite to maximize the benefits from both materials: the body is made of aluminium, so really really stiff. For this reason all the gears are working in the perfect position and will do it for years. The rotor, made of carbon, is suffering less solicitations and so it is made of lighter material. The rotor is equipped with a thick hollow bail arm, super strong and impossible to deform. The reel comes with two aluminium spools, both machined from a single aluminium piece. One of the two has been designed for monofilament and it is high capacity, while the other, designed for braided lines, is shallower and features a rubber band to prevent the braided

sliding. The lip of both spools is built with an angle, giving birth to the V-Spool Design, a solution that allows the line to come out easier and increasing casting distance. Drags are made of stainless steel and carbon discs and are sealed, to prevent dirty and salt to enter between the discs. The handle too is machined from a single piece of aluminium. 9+1 stainless steel double shielded bearings make this reel really smooth. The Invictus has a ratio of 5.2:1 and it is suitable for bolo and waggler fishing in sizes 2500 and 4000, while it is perfect for spinning and feeder fishing in sizes 4000 and 5000. The gears have been designed to bear thousands and thousands of casts and retrieves.

FEATURES

- Super stiff aluminium body
- Aluminium side cover
- Ultralight carbon rotor
- Aluminium hollow bail
- Anti-twist Titanium line roller
- Main deep aluminium spool (on twin BB)
- Spare match aluminium spool, featuring a rubber band to avoid braided lines slipping under extreme tension
- Sealed drag to avoid water, salt and dust getting inside



- Stainless steel main shaft
- Infinite anti-reverse
- Stainless steel double shielded ball bearings
- CNC handle, machine cut from a single piece of solid aluminium



The high capacity spool has parallel grooves in the throat, which are intended to give a correct start to line's spooling. That's why the spool's label must always be removed!



The spare spool has a reduced capacity to ease thin line's loading. The central rubber band is there to avoid braided line's slipping under extreme pulls.



All ball bearings are sealed on both sides to keep grease inside and avoid water, sand and salt getting in and possibly affecting their rotation.



On each side of the body there are two steel plates, which are destined to raise stiffness along handle axis. The positive effect is easily felt during a fish fight.



The reel's structure is an hi-tech "full metal", as both body and side cover are made from aluminium to offer the best possible stiffness and durability.

On right, the Invictus rotor is made from high modulus carbon, the stiffest and lightest among the materials which can bear enormous load and stress. Its essential design is not only a fantastic fashion detail, but plays an important role on balance and rotation smoothness points of view. As a matter of fact, its lightness pushes back the reel's barycentre, while reducing the energy needed to cause the rotation. The computer drew it asymmetric in order to counterbalance the bail's weight, thus optimizing the rotation's smoothness of the whole reel.



Code	Model	Weight	Gear Ratio	Spool Capacity	Max Drag	Extra Sp.	B.B.
033-98-250	2500	275	5.2:1 (76 cm)	Ø 0.26 mm - 200 m	7.3 kg	1	9+1
033-98-400	4000	310	5.2:1 (84 cm)	Ø 0.28 mm - 260 m	10 kg	1	9+1
033-98-500	5000	330	5.2:1 (88 cm)	Ø 0.31 mm - 250 m	10 kg	1	9+1
033-98-251	Alum. Spare Spool 2500 - Deep			Ø 0.26 mm - 200 m			
033-98-252	Alum. Spare Spool 2500 - Match			Ø 0.20 mm - 100 m			
033-98-401	Alum. Spare Spool 4000 - Deep			Ø 0.28 mm - 260 m			
033-98-402	Alum. Spare Spool 4000 - Match			Ø 0.20 mm - 150 m			
033-98-501	Alum. Spare Spool 5000 - Deep			Ø 0.31 mm - 250 m			
033-98-502	Alum. Spare Spool 5000 - Match			Ø 0.26 mm - 130 m			

MANIAC



NEW MANIAC FD

All anglers intensely love their hobby and often their friends tell them they're like maniacs. Very likely they are right, and that's why we designed the Maniac reel, that is a reel that won't miss to make an impression for the incredible combination of sturdiness and smoothness. The whole reel is made from strong aluminium to make it a master piece of strength. The body, the side cover and the rotor, everything is made from aluminium. And so are the tubular bail arm, the spool and the handle. Both the spool and the handle are CNC machine cut from a single piece of pure aluminium. The drag system is not weaker and it is really smooth, featuring alternate stainless steel and carbon washers. The spool features a bent lip, the so called V-Spool Design, to help the line to come out easier. The central part of the spool is covered with a rubber band to prevent the braided lines sliding under strong traction. The 9+1 bearings are made from stainless steel and double shielded. Available in 3 sizes, the Maniac is a reel that will make a difference, especially when you need a strong cranking power. We think Maniac is the best choice for anglers fishing with feeder in fast flowing rivers, with bombardas for lake trout or beach legering.

FEATURES

- Hi-Tech metal body
- CNC carved aluminium spool (shallow match type)
- Hollow Power Bail with Anti Twist line roller
- Carbon and steel disks drag
- Sealed drag



- Sealed stainless steel ball bearings
- Infinite Anti-reverse

POWERBAIL



Code	Model	Weight	Gear Ratio	Spool Capacity	Max Drag	Extra Sp.	B.B.
034-11-250	2500	280	5.2:1 (76 cm)	Ø 0.205 mm - 120 m	7.3 kg	-	9+1
034-11-400	4000	315	5.2:1 (84 cm)	Ø 0.205 mm - 150 m	10 kg	-	9+1
034-11-500	5000	332	5.2:1 (84 cm)	Ø 0.260 mm - 130 m	10 kg	-	9+1
034-11-251	Alum. Spare Spool 2500			Ø 0.205 mm - 120 m			
034-11-401	Alum. Spare Spool 4000			Ø 0.205 mm - 150 m			
034-11-501	Alum. Spare Spool 5000			Ø 0.260 mm - 130 m			



The Maniac drag box include a set of high technology disks, with same style of big game multipliers. The alternation of steel and carbon elements provides power, smoothness and heat dispersion for safe and comfortable control of the fish run.



The handle operates directly on to the drive gear. This solution is the best one for integral power transmission, because energy generated during retrieve is not dispersed through plays and vibrations. For transport, the handle can be fold down to reduce the volume of the reel.

Maniac is prepared for sea fishing, and for such reason the drag box is sealed by a soft rubber lining which avoids water, sand and salt getting inside. Of course, it's highly recommended to wash the reel under tap water after each fishing session.

XENOS cx

A really nice reel which combines the excellent gearing quality to a sporting, young design. The ultralight body helps reducing weight without missing stiffness, thanks to the advanced engineering of the structure. The rotation's smoothness is coming from 9 stainless steel high precision double shielded ball bearings and the stainless steel one way clutch. The spool is itself an hybrid, aluminium/carbon in this case, and it is really light. The spooling is just perfect, thanks to the S-Curve System that spread homogeneously the line with a slow oscillation. The final hybrid part is the custom handle: stainless steel/carbon with EVA knob. The brilliant Xenos is not an hybrid though: it is 100% quality only.

FEATURES

- Ultra Light CX Carbon Body
- Hybrid aluminium/carbon main spool
- Graphite Extra Sp.
- Double Shielded SS Long Life Ball Bearings
- Instant anti-reverse system
- Titanium Line Roller



- Carbon Cover Drag Knob
- Hybrid Carbon SS Handle
- X-Power Drive
- Eva ergonomic handle knob

POWERBAIL



Code	Model	Weight	Gear Ratio	Spool Capacity	Extra Sp.	B.B.
033-89-400	4000	265	5.0:1 (80 cm)	Ø 0.25 mm - 220 m	1	9+1



NEW AIRMAG



If light weight is nice, then for sure the Airmag is beautiful! Featuring a super light weight magnesium body and a carbon rotor, the Airmag is the candidate to become the perfect reel to match with high end bolo rods and top class match rods. The tubular aluminium bail arm is super light as well. The main spool is made from cold forged aluminium and equipped with a super smooth drag, featuring stainless steel and carbon washers. The newly designed handle is very light and extremely stiff. To stay on light weight concept, even the spare spool is super light, being made from graphite. We also need to highlight the high speed ratio 6.0:1. Speed, light weight and smoothness, these three peculiarities make the Airmag the best reel for competition. The 7+1 bearing are made from stainless steel and double shielded, so you can use your Airmag during your next vacation on the sea!



FEATURES



- Ultralight yet stiff Magnesium alloy body
- Superlight carbon rotor
- Aluminium Longcast main spool
- Graphite spare spool
- Aluminium hollow bail

- Sealed drag with carbon disks
- Sealed stainless steel ball bearings
- Infinite anti-reverse
- Aluminium handle

POWERBAIL



Code	Model	Weight	Gear Ratio	Spool Capacity	Max Drag	Extra Sp.	B.B.
033-97-300	3000	245	6.0:1 (85 cm)	Ø 0.16 mm - 100 m	6.5 kg	1	7+1
033-97-400	4000	250	6.0:1 (94 cm)	Ø 0.20 mm - 100 m	6.5 kg	1	7+1

XPLORE



XPLORE

The design of a new reel model requires long times and when in the end we come to the final product we always feel satisfied. When we finished the Xplore project the satisfaction was really huge because we thought to have achieved a result that far exceeded our initial expectations. The Xplore is just the reel we all fell in love with and we are sure that everybody will test it, then will show the same feeling. The extra stiff graphite body includes a heart made of powerful and reliable stainless steel gears supported by 9+1 premium quality bearings, also them made of stainless steel and double shielded for protection for dirty and water. The aluminium spool features a V shape lip for easier line casting and includes a sealed drag with oversized stainless steel and carbon washers. This solution is perfect for a smoother drag with no initial momentum. The positive screw aluminium handle is adding precision and it is equipped with a non-slip high density EVA knob. Available in sizes from 3000 to 5000. We are sure this model will have a great success cause of its versatility and its undisputed quality.

FEATURES

- Stainless Steel Main Shaft & Main Gear Shaft
- Stainless Steel One Way Clutch
- Double Shielded SS Long Life Ball Bearings
- Aluminium spool with holes
- Twin Ball Bearing Spool
- Micro-Adjusting Front Drag With Stainless Steel And Carbon Textile Drag Washers
- Fully sealed Drag
- Positive-Screw-Lock CNC Handle & Fighting Knob
- Titanium Line Roller
- Aluminium handle directly connected to drive gear



Code	Model	Weight	Gear Ratio	Spool Capacity	Extra Sp.	B.B.
033-85-300	3000	270	5.2:1 (78 cm)	Ø 0.235 mm - 240 m	-	9+1
033-85-400	4000	290	5.2:1 (84 cm)	Ø 0.260 mm - 290 m	-	9+1
033-85-500	5000	300	5.2:1 (88 cm)	Ø 0.285 mm - 290 m	-	9+1
033-85-301	Alum. Spare Spool 3000			Ø 0.235 mm - 240 m		
033-85-401	Alum. Spare Spool 4000			Ø 0.260 mm - 290 m		
033-85-501	Alum. Spare Spool 5000			Ø 0.285 mm - 290 m		

XPLORE MATCH NEW

In 2014 Trabucco presented the Xplore reel and if you are expert and passionate anglers and now you are not using one, that means you are part of a minority or that you missed a super performing reel.

In 2015 Trabucco presents the Match version of the Xplore, designed for competition anglers. The Xplore Match is a reel designed for the competition and features super smooth gears and low capacity spool, designed to be filled with the right quantity of monofilament. It fits bolo, match, trout and light feeder rods. The 2000 size is perfect for light bolo and light match rods and has a capacity of 100 m of 0.20 mm line. The 4000 size is fitting most of the match rods and has a capacity of 120 m of 0.26. Finally the 5000 size is perfect for feeder fishing, with a capacity of 130 m of 0.26 mm. The latter model spool is wider and so it is better for long distance casting. The super smooth gears are supported by 9+1 stainless steel double shielded bearings.

FEATURES

- Extra tough body and rotor
- V-shaped aluminium spool
- Aluminium hollow bail
- Sealed drag
- Double shielded stainless steel ball bearings
- Infinite anti-reverse
- CNC machine cut handle made from a solid piece of aluminium



Code	Model	Weight	Gear Ratio	Spool Capacity	Extra Sp.	B.B.
033-91-250	2500	270	5.2:1 (76 cm)	Ø 0.20 mm - 100 m	-	9+1
033-91-400	4000	290	5.2:1 (84 cm)	Ø 0.26 mm - 120 m	-	9+1
033-91-500	5000	300	5.2:1 (88 cm)	Ø 0.26 mm - 130 m	-	9+1
033-91-251	Alum. Spare Spool 2500			Ø 0.20 mm - 100 m		
033-91-401	Alum. Spare Spool 4000			Ø 0.26 mm - 120 m		
033-91-501	Alum. Spare Spool 5000			Ø 0.26 mm - 130 m		

LANCER HS

Latest generation spinning reel with super compact carbon body, very light but powerful and strong. The CNC machined aluminium long cast spool has a very large diameter to allow longer and more accurate casting. The main shaft is bigger than usual to support the increased turning mass while the titanium coated line roller dissipates more efficiently both the heat and the line twists. The reel is super smooth thanks to the premium quality of the 9 double shielded stainless steel ball bearing and the one way clutch. The drag is micro adjusting at the most precision level thank to the huge diameter drag washers. It is available in 4500 and 5500 sizes.



FEATURES

- Advanced design oversized aluminium spool



- Ultra Light CX Carbon Body
- Double Shielded Stainless Steel Long Life Ball Bearings
- Titanium Line Roller
- Carbon Cover Drag Knob
- Aluminium handle
- Eva ergonomic handle knob

POWERBAIL



Code	Model	Weight	Gear Ratio	Spool Capacity	Extra Sp.	B.B.
033-88-450	4500	295	5.0:1 (86 cm)	Ø 0.18 mm - 150 m	-	9+1
033-88-550	5500	320	5.0:1 (95 cm)	Ø 0.23 mm - 150 m	-	9+1
033-88-451	Alum. Spare Spool 4500			Ø 0.18 mm - 150 m		
033-88-551	Alum. Spare Spool 5500			Ø 0.23 mm - 150 m		



VERTEX



Family of front drag reels fully built in aluminium, with extremely tough and reliable body. This reel can actually stand the toughest fights. Main spool and handle arm are also made from aluminium. This compact reel is really handy and suited for predator fishing, especially with live bait. Its strength points are, besides the full metal body, the power drag and the low gear ratio. Gears are extremely smooth, thanks to seven

stainless steel ball bearings and the one way clutch. An extremely rugged reel with top precision gear.

FEATURES

- Aluminium & graphite Hybrid body
- Aluminium main spool
- Double Shielded SS Long Life Ball Bearings
- Titanium Line Roller
- Carbon Cover Drag Knob
- Infinite anti-reverse
- Aluminium handle



POWERBAIL



Code	Model	Weight	Gear Ratio	Spool Capacity	Extra Sp.	B.B.
033-68-400	4000	290	5.0:1 (72 cm)	Ø 0.25 mm - 200 m	-	7+1
033-68-600	6000	410	4.6:1 (84 cm)	Ø 0.35 mm - 200 m	-	7+1

AIRBLADE



WHEN
LIGHTNESS IS
THE NORM

FEATURES

- Super Light Rotor - Using space-craft materials, the rotor is now lighter and tougher.
- Innovative One Touch Handle - EVA covered balanced handle knob made from ABS shock resistant material.
- No gaps between side covers and no screws on exterior parts.
- Ultra Slim spacecraft metal body, lighter but stronger than graphite. All gears are protected by a single super resistant shell.
- Easy maintenance. Lubricating has never been so easy. Access from back part of the reel.



Code	Model	Weight	Gear Ratio	Spool Capacity	Extra Sp.	B.B.
033-70-200	2000	244	5.1:1 (67c m)	Ø 0.20 mm – 150 m	-	7+1
033-70-300	3000	250	5.1:1 (72 cm)	Ø 0.25 mm – 175 m	-	7+1
033-70-400	4000	260	5.1:1 (83 cm)	Ø 0.30 mm – 125 m	-	7+1
033-70-201	Alum. Spare Spool 2000			Ø 0.20 mm – 150 m		
033-70-301	Alum. Spare Spool 3000			Ø 0.25 mm – 175 m		
033-70-401	Alum. Spare Spool 4000			Ø 0.30 mm – 125 m		

AIRBLADE

Nowadays it is quite hard to show something really new. But we strongly believe the Airblade Pro will be able to amaze, surprise and make many anglers fall in love with it. It is a brand new concept that requested a wide variety of new technologies and knowledge to create it. And each single innovation has been carried to increase your fishing experience. The body is a mono piece of spacecraft metallic alloy 7075 hosting the whole gears ensemble. Sides are part of the main body and so there are no gaps between main body and side plates and consequently no screws on the body of the reel! Therefore, all this is a kind of one-piece ensemble that can be lubricated through a special lower port, the unique way to get in. And what about measurements? The critical point of every reel is the oscillation gear, that specific part that under different commercial names is responsible of the line lay. This is usually the thicker part of every reel on the market.

But the Airblade is only 12 mm thick in that position. Just Incredible! No other words to define that. The whole body is so thin and innovative, and all the gears, rotor, bail arms and everything else is made of the same special space grade metallic alloy, getting 2 results: to have a durable and super light weight reel (only 260 grams on size 4000). Beside this, a reel with so many (actually every) metallic parts can be cosmetized in thousands of ways, just anodizing those parts. The reel is very smooth, using 7 super high quality ball bearing and one way clutch.



The wide success of Air Blade concept has given the start to a revolutionary new model which offers all the advantages of "free runner" system, without the negative aspects due to weight and volume of the gears intended to manage it.



NEW AIRBLADE FS

At first sight, it's a brilliant front drag reel; lightweight, wide spool, ultraslim metal body, smooth rotation, precise bail trip, perfect drag function, one touch folding handle. But an accurate inspection tells you that the spool's skirt must play an unusual role, because it's free from spool's structure and can be manually rotated to engage the free runner mechanism. What does it mean? The free runner system is, practically, a bit loose second drag, which leaves the spool free to turn and give line to the fish, so that it can develop the first run without any risk for the hooklink. The light drag tension is important to avoid backlash, which would be inevitable in case of total spool's freedom. When the user decides to start line retrieve, he must simply push forward the handle by one quarter of turn: in this way, the free runner is automatically disengaged and main drag gets into play, of course at level previously set by the user. A click

sound informs that free runner system is off, and the fun starts! Big fish are of course the main target of this reel: carp, barbel, mullet, seabass and sea bream, which fall to the bait carried by float or feeder rig presented through definitely finer hooklinks, as the line now gets the protection from Trabucco free runner!



The spool's skirt is milled to provide enough grip to user's fingers. A slight clockwise rotation puts main drag off and makes the free running system start, while a click sound confirms that everything is ok.

FEATURES

- Ultraslim body made from spacecraft metal alloy
- No screws on exterior parts
- Superlight rotor made from spacecraft metal alloy
- Aluminium spool
- Titanium Line Roller
- Free Runner system
- Infinite anti-reverse
- Aluminium one touch folding handle



After a few centimetres of handle rotation, the free runner system is automatically disengaged, and main drag system gets into play, of course at level previously set by the user at the start of fishing session.



The free runner system fitted on new Air Blade FD is quite efficient, because it works right in the heart of the reel, exactly on the big roller anti-reverse bearing. No power dispersion means superior smoothness, specially in the vital moment of first fish run!

Code	Model	Weight	Gear Ratio	Spool Capacity	Extra Sp.	B.B.
033-72-400	4000	280	5.1:1 (83 cm)	Ø 0.25 mm - 210 m	-	7+1
033-72-401	Alum. Spare Spool 4000					

SKORPION



Maurizio Fedeli

NEW SKORPION

Strong and accurate: these are two of the main specifications of a Skorpion. The body is made from aluminium and the rotor is made from light weight graphite. Due to this construction, the body is really stiff and all the inner gears will always work perfectly, even under heavy load. The spool is made from cold forged aluminium, while the handle is made from machine cut aluminium. The spooling is perfect due to the Worm Shaft Gear. The Skorpion comes with a second graphite spool having same capacity of the main one. The 7+1 bearings are stainless steel Long Life quality.

FEATURES

- Hybrid body made from aluminium and graphite
- Ultralight aluminium main spool
- Graphite spare spool
- Hollow bail with anti twist line roller
- Micro-adjustable drag with oversized washers
- Long Life stainless steel ball bearings



- Infinite anti-reverse
- Worm shaft system for a perfect line lay
- Power Fight aluminium handle with EVA knob



The infinite anti-reverse system works thanks to this oversized roller's bearing.



A lot of slim holes make the aluminium spool lighter and nice.



Thanks to its special design, the worm shaft is responsible of perfect line lay on reel's spool, with neat angles between each coils. As a consequence, the casting distance is improved, due to easier line flow. This important part is hidden in the Skorpion's body.



Code	Model	Weight	Gear Ratio	Spool Capacity	Extra Sp.	B.B.
034-12-200	2000	290	5.2:1 (72 cm)	Ø 20 mm - 230 m	1	7+1
034-12-400	4000	365	5.2:1 (82 cm)	Ø 20 mm - 285 m	1	7+1

NEW FIRESTAR



Firestar is yet another reel exploiting the same hybrid body technology, taking the advantage of both aluminium and graphite. The foot and the frame of this reel are aluminium made, while all the other parts are graphite made. The tubular bail arm is made of aluminium too. Both the main spool and the handle are made of machined cut aluminium. The drag is one of the strong points of this reel, featuring oversized washers able to disperse heat and to be regulated with great accuracy. A spare graphite spool comes inside the

box. The powerful gears work with remarkable smoothness cause of 5+1 Long Life stainless steel bearings.

FEATURES

- Hybrid body made from aluminium and graphite
- Ultralight aluminium main spool
- Graphite spare spool
- Hollow bail with anti twist line roller
- Micro-adjustable drag with oversized washers



- Long Life stainless steel ball bearings
- Infinite anti-reverse
- Power Fight aluminium handle with EVA knob

POWERBAIL US3 ULTRA SLIM BODY DESIGN AS ROLLER ANTI-TWIST SYSTEM ONE WAY CLUTCH GJV CROSS WINDER

Code	Model	Weight	Gear Ratio	Spool Capacity	Extra Sp.	B.B.
033-95-300	3000	285	5.1:1 (67 cm)	Ø 22 mm - 160 m	1	5+1
033-95-400	4000	330	5.1:1 (74 cm)	Ø 25 mm - 150 m	1	5+1



NEW NEOX

It is not easy to find a family of reels that can be able to fit such a large number of different fishing techniques as the Neox family does. Available in 4 sizes and equipped with top level technical features, this 2015 news from Trabucco will make a name of itself, doesn't matter which fishing technique involved. Hybrid body, that is aluminium made foot and frame, graphite side plates and rotor, to lower the overall weight without affecting the overall stiffness: this is the secret. The aluminium spool has been widely perforated to lower the weight too. A spare graphite spool is available inside the trading box. The aluminium handle is longer than usual, to get extra cranking power. The drag is very smooth and can be calibrated with great accuracy. The smoothness of the gears is supported by 9+1 Long Life stainless steel bearings placed in the higher friction points.

FEATURES

- Hybrid body made from aluminium and graphite
- Ultralight CNC aluminium main spool
- Graphite spare spool
- Hollow bail with anti twist line roller
- Micro-adjustable drag with oversized washers



- Long Life stainless steel ball bearings
- Infinite anti-reverse
- Power Fight aluminium handle

POWERBAIL US3 ULTRA SLIM BODY DESIGN AS ROLLER ANTI-TWIST SYSTEM ONE WAY CLUTCH GJV CROSS WINDER

Code	Model	Weight	Gear Ratio	Spool Capacity	Extra Sp.	B.B.
033-78-200	2000	250	5.1:1 (63 cm)	Ø 20 mm - 195 m	1	9+1
033-78-300	3000	285	5.1:1 (66 cm)	Ø 25 mm - 245 m	1	9+1
033-78-400	4000	300	5.1:1 (72 cm)	Ø 30 mm - 195 m	1	9+1
033-78-600	6000	400	5.1:1 (86 cm)	Ø 50 mm - 155 m	1	9+1

MAGNEX



MAGNEX

Magnex outstands for its innovative and modern design, but just fishing with it you'll understand the real performance of this reel. Entirely designed in Japan with the latest 3D software, it's packed full of the latest technology, all enclosed in a X-Tra Tough body extremely lightweight and strong in the same time to eliminate any vibration. The LLG gears are fitted on 5 S.S Long Life ball bearings, combined with 1 Roller Bearing running the one-way clutch. The V-Shaped rotor is assisted by the IRSS system to prevent accidental bail closure, whilst the the PowerBail helps the overall balance without increasing the weight. The aluminium spool features large holes to reduce again unnecessary weight, and the Advanced Power Drag is completely sealed, running on oversized drag washers and with the addition of a ball bearing to increase the smoothness. As a result the drag is extremely precise, progressive and powerful. A concentrate of cutting edge technology and performance, offered to an affordable price, ideal for both freshwater and saltwater fishing from the bolo, waggler or feeder fishing, to the spinning.

FEATURES

- X-tra tough graphite body
- Cnc Machine Cut Long Cast Superlight Aluminium Spool
- Rotary Flat Oscillation System
- V-Shaped Rotor
- Cold forged One Touch aluminium folding handle
- Front Drag System With Sealed Ptfе Coated Magnun Drag Washers



POWERBAIL **AVS** **AS ROLLER ANTIPIST SYSTEM** **ONEWAY CLUTCH** **G.W. CROSS WINNER**

Code	Model	Weight	Gear Ratio	Spool Capacity	Extra Sp.	B.B.
038-62-100	1000	269	5.1:1 (72 cm)	Ø 0.18 mm - 215 m	-	5+1
038-62-200	2000	279	5.1:1 (78 cm)	Ø 0.18 mm - 240 m	-	5+1
038-62-300	3000	310	5.0:1 (86 cm)	Ø 0.25 mm - 245 m	-	5+1
038-62-400	4000	322	5.0:1 (92 cm)	Ø 0.30 mm - 195 m	-	5+1

KEIRAN



Keiran series was born from a project that included European and Japanese designers to build an original shaped spinning reel with high end performance. It is evident the Keiran is not a cheap reel nor that is a reel for beginners. On the contrary, it is a super technological reel able to really satisfy the most demanding pleasure anglers as well as most qualified match anglers. The ultra compact body is the key to get a super robust and smooth gear. The free running sensation is enhanced by the precision high quality material gears that turn exactly like a Swiss clock. The aluminium spool has been made much more light applying a wise cutting that is not influencing the rotation nor affecting balance in a bad way. Between the excellent features, we want to highlight the extra light but extra tough carbon handle, refined with an EVA knob for extra firm cranking.

FEATURES

- Stainless Steel Main Shaft & Main Gear Shaft
- Hybrid Carbon & Aluminum Spool
- Graphite spare spool
- Double Shielded SS Long Life Ball Bearings
- Hybrid Carbon SS Handle
- Titanium Line Roller



Code	Model	Weight	Gear Ratio	Spool Capacity	Extra Sp.	B.B.
033-77-200	2000	253	5.1:1 (68 cm)	Ø 0.20 mm - 195 m	1	9+1
033-77-300	3000	277	5.1:1 (71 cm)	Ø 0.25 mm - 245 m	1	9+1
033-77-400	4000	293	5.1:1 (77 cm)	Ø 0.30 mm - 195 m	1	9+1

POWERBAIL AS ROLLER ANTI TWIST SYSTEM US3 ULTRA SLIM BODY DESIGN ONE WAY CLUTCH GXV CROSS WINDER

SPARK

Interesting series of front drag reels, compact body, rugged and very smooth. Three sizes available 2000, 3000 and 6000 to match more popular fishing techniques. Main body is graphite, while the spool is made of super light, cold forged aluminium, as well as the handle. Reliable material for a reliable reel. Spark features 7 precision ball bearings and a one way clutch. Very good line lay, thanks to the cross winding system. The spooled line is never stressed, thanks to the anti twist titanium line roller. Oversized discs drag is just perfect, and allows an accurate set up.



FEATURES

- X-tra tough graphite body
- Aluminium main spool
- Graphite spare spool
- Double Shielded SS Long Life Ball Bearings
- Titanium Line Roller



SBS Super Balance System POWERBAIL AS ROLLER ANTI TWIST SYSTEM ONE WAY CLUTCH GXV CROSS WINDER

Code	Model	Weight	Gear Ratio	Spool Capacity	Extra Sp.	B.B.
033-62-200	2000	265	5.0:1 (69 cm)	Ø 0.18 mm - 240 m	1	7+1
033-62-300	3000	270	5.0:1 (71 cm)	Ø 0.20 mm - 240 m	1	7+1
033-62-600	6000	390	5.5:1 (95 cm)	Ø 0.35 mm - 200 m	1	7+1





NEW LEXAN

Entirely made of extra stiff graphite, the Lexan is a reel available in 3 sizes and that can be used in a variety of situations and fishing techniques. Spool and handle are made of machined cut aluminium. The smoothness is very good, thanks to the use of 5+1 Long Life stainless steel bearings. The Lexan is a superior performance reel that is offered at a very convenient price.



FEATURES

- Graphite body
- Ultralight CNC aluminium main spool
- Graphite spare spool
- Hollow bail with anti twist line roller
- Micro-adjustable drag with oversized washers
- Long Life stainless steel ball bearings
- Infinite anti-reverse
- Power Fight CNC aluminium handle



Code	Model	Weight	Gear Ratio	Spool Capacity	Extra Sp.	B.B.
034-13-200	2000	260	5.5:1 (76 cm)	Ø 20 mm - 230 m	1	5+1
034-13-400	4000	315	5.2:1 (81 cm)	Ø 30 mm - 175 m	1	5+1
034-13-600	6000	415	5.2:1 (93 cm)	Ø 45 mm - 140 m	1	5+1

NEW EXXON

If you are searching for a small sized body reel that is still able to face challenging fishing techniques, then the Exxon is for sure the best choice you can do. To get an optimal compromise between light weight and stiffness, we built the Exxon with hardened graphite. The super light main spool is made of cold forged aluminium, while the spare spool is graphite made. Spooling is one of the strong points of this reel, and you can use very thin lines without getting any problem. The machined cut aluminium handle, together with the 5+1 Long Life stainless steel bearings, complete the equipment of this reel that can be used for Bolognese fishing and for light and ultra light spinning.

FEATURES

- Super stiff hi-tech graphite body
- Ultralight aluminium main spool
- Graphite spare spool
- Hollow bail with anti twist line roller
- Micro-adjustable drag with oversized washers
- Double shielded stainless steel ball bearings
- Power Fight aluminium handle



Code	Model	Weight	Gear Ratio	Spool Capacity	Extra Sp.	B.B.
033-94-200	2000	260	5.1:1 (62 cm)	Ø 20 mm - 140 m	1	5+1
033-94-300	3000	295	5.1:1 (64 cm)	Ø 20 mm - 200 m	1	5+1
033-94-400	4000	315	5.1:1 (72 cm)	Ø 25 mm - 150 m	1	5+1

NEW WINDLEX



Aggressive look and high technology in the same reel, this is the Windlex, a reel offering a great value for the money. The super smooth gears are hosted inside a super stiff graphite body and supported by 5+1 Long Life stainless steel bearings. Such a configuration is pretty unusual for this price point. The high quality handle is aluminium machined cut and it is longer than usual, to add cranking power to the already powerful gears. The tubular bail arm is sturdy and stress resistant. A spare graphite spool is available inside the trade box.

FEATURES

- Super stiff hi-tech graphite body
- Longcast CNC aluminium main spool
- Graphite spare spool
- Hollow bail with anti twist line roller
- Micro-adjustable drag with oversized washers



- Long Life stainless steel ball bearings
- Infinite anti-reverse
- Power Fight aluminium handle with Soft Touch knob

US3 ULTRA SLIM BODY DESIGN

POWERBAIL

ONEWAY CLUTCH

AS ROLLER ANTI TWIST SYSTEM

SBS Super Balance System

SOS SLOW OSCILLATION SYSTEM

Code	Model	Weight	Gear Ratio	Spool Capacity	Extra Sp.	B.B.
033-93-200	2000	265	5.1:1 (62 cm)	Ø 20 mm - 140 m	1	5+1
033-93-300	3000	305	5.1:1 (64 cm)	Ø 22 mm - 160 m	1	5+1
033-93-400	4000	335	5.1:1 (72 cm)	Ø 25 mm - 150 m	1	5+1



NEW MITO XTC

The Mito is presented in 4 sizes to satisfy the needs of almost any angler of fresh and salt water. Very good refined and evocative in its striking white and black dress, this model has body and rotor graphite made and a cold forged aluminium spool. The handle is machined cut aluminium. The smoothness is brilliant, thanks to 5+1 Long Life stainless steel high quality bearings. The tubular aluminium bail arm is a quality one, super tough and crush-proof. The main spool, together with the spare graphite one, feature wide super smooth, heat dispersing, drag washers.

FEATURES

- Super stiff hi-tech graphite body
- Ultralight aluminium main spool
- Graphite spare spool
- Hollow bail with anti twist line roller
- Micro-adjustable drag with oversized washers



- Long Life stainless steel ball bearings
- Infinite anti-reverse
- Power Fight aluminium handle with Soft Touch knob

US3 ULTRA SLIM BODY DESIGN

POWERBAIL

SBS Super Balance System

AS ROLLER ANTI TWIST SYSTEM

ONEWAY CLUTCH

SOS SLOW OSCILLATION SYSTEM

Code	Model	Weight	Gear Ratio	Spool Capacity	Extra Sp.	B.B.
033-92-200	2000	250	5.1:1 (63 cm)	Ø 20•195 m	1	5+1
033-92-300	3000	285	5.1:1 (66 cm)	Ø 30•170 m	1	5+1
033-92-400	4000	300	5.1:1 (72 cm)	Ø 35•145 m	1	5+1
033-92-600	6000	405	5.1:1 (85 cm)	Ø 45•195 m	1	5+1

KRONOS XT

From ultralight spinning to bolognese, from waggler to feeder fishing, this nice reel series gets everybody happy with its fantastic quality/price ratio, which gave it a strong popularity and wide diffusion in Italy as well as abroad. In Italy the cosmetic and design are always first elements of evaluation, while in the central Europe the strength and performances are taken into serious consideration, and also on such front the Kronos XT offers the best that money can buy. The Kronos XT features 5 ball bearing + one way clutch. The aluminium spool has a tapered profile, allowing longer casts. The aluminium handle grants great cranking power and extra reliability. The icing on the cake is a superior drag system, really smooth, usually found only on much much more expensive reels.

FEATURES

- Graphite body
- Ultralight aluminium main spool
- Graphite spare spool
- Hollow bail with anti twist line roller
- Micro-adjustable drag with oversized washers
- Long Life stainless steel ball bearings
- Infinite anti-reverse
- Aluminium handle



Code	Model	Weight	Gear Ratio	Spool Capacity	Extra Sp.	B.B.
033-80-200	2000	245	5.1:1 (68 cm)	Ø 0.20 mm - 300 m	1	5+1
033-80-300	3000	284	5.1:1 (71 cm)	Ø 0.25 mm - 265 m	1	5+1
033-80-400	4000	300	5.1:1 (77 cm)	Ø 0.30 mm - 250 m	1	5+1

NEW QOSMIO cx

The Qosmio project is really interesting and it is made of two sizes, a 3000 and a 4000 graphite compact bodies equipped with a cold forged aluminium spool. The wide diameter



of the spool will help to increase the casting distance. Qosmio are made in a very simple but functional way, exploiting powerful smooth gears supported by 3+1 Long Life stainless steel bearings. Despite the good price, the Qosmio is really smooth and offers even a second graphite spool and a cold forged aluminium handle. Not easy to find similar equipment at this price point!

FEATURES



- Super stiff hi-tech graphite body
- Longcast CNC aluminium main spool
- Graphite spare spool
- Traditional bail with anti twist line roller
- Micro-adjustable drag with oversized washers
- Long Life stainless steel ball bearings
- Infinite anti-reverse
- Power Fight aluminium handle with rubber knob



Code	Model	Weight	Gear Ratio	Spool Capacity	Extra Sp.	B.B.
033-96-300	3000	255	5.0:1 (71 cm)	Ø 25 mm - 200 m	1	3+1
033-96-400	4000	255	5.0:1 (71 cm)	Ø 30 mm - 160 m	1	3+1



The aluminium handle is swept to follow rotor shape. This detail positively affects rotation balance - specially at high speed - as the handle's weight is closer to reel's centre of gravity.



Great care has been put in every detail, with stylish holes in spool's skirt and nice windows which make the rotor lighter.



The micro grooves which are visible on the spool through a magnifier lens are the signs left by CNC machine. This proves that it has actually been carved from a solid piece of aluminium to obtain extreme strength.

TRONIK XTR5

This exclusive reel has been designed and engineered by the same team of technicians that created the Airblade and for some aspects it resumes certain concepts. If the first reel featured a completely new shape, the second one, the Tronik, seems to be a brilliant summary of old and new styles. The shape of the body and rotor is futuristic, rich in round bends and empty spaces. These shape is futuristic but it is remembering as well the reels with circular bodies of our grandfathers.

Technically, the body is a single graphite frame including the 5.1:1 gears where a unique aluminium handle is set. The handle is bent around its own axis, being this way more innovative but also stiffer. Like for Airblade, it's possible to fold it just pushing the red button, so reducing the volume of the reel to easily store the rod into the holdall. The spool is a hybrid aluminium and graphite, giving a strong visual impact and a very low weight. Inside the spool, the drag system features extra large washers, up to 30% wider than usual, and it is so really micro adjusting. Bail arms are always a critical point and they have been made in aircraft aluminium. 5 ball bearings support the inner gears. It is appropriate to underline here that cause of the very narrow body, only 16mm without the side covers, it was not possible to put a one way clutch inside. For that purpose, the team of engineers designed an innovative semi-infinite anti reverse system that can work without the one way clutch. This solution is on the other hand very good to increase the cranking power of the reel, because the normally used one way clutch are often responsible of cranking power decrease up to 30%. Once again Trabucco is in the forefront of innovations in fishing tackle!

FEATURES

- Super Light Rotor. Using spacecraft materials the rotor is lighter and tougher.
- Innovative one touch handle, with EVA covered balanced handle knob made from ABS shock resistant material.
- No gap between side covers and no screws on exterior parts.



Code	Model	Weight	Gear Ratio	Spool Capacity	Extra Sp.	B.B.
033-90-400	XTR 5	273	5.1:1(83 cm)	Ø 0.250 mm - 210 m	1	5



LEGACY FD

NEW

Here is the Legacy second edition, a family of reels that confirmed to be able to amaze all the anglers cause of its performance. The amazing look of this reel is just enhancing the great technical value. The gears are super smooth due to the 2+1 stainless steel bearings positioned in the locations suffering the highest friction. Body and balanced rotor are made of light and stiff graphite, to contain the total weight. The stiffness of the graphite is a warranty of a long life of all inner gears. The bail arm is equipped with anti twist line roller, very important for long fishing sessions with no line problems. The main spool is really nice, made of anodized aluminium and corrosion free. The spare spool is super light graphite made. To increase cranking power the Legacy features a cold forged aluminium handle. The great range of models can really satisfy all the needs, from fresh to salt water. From 1000 size, specific for finesse fishing to 6000 for bottom fishing, passing through the 4000 that is a really allround size.

FEATURES

- Graphite body
- Ultralight CNC aluminium spool
- Graphite spare spool
- Traditional bail with anti twist line roller
- Micro-adjustable drag with oversized washers
- Long Life stainless steel ball bearings
- Infinite anti-reverse
- Aluminium handle



Code	Model	Weight	Gear Ratio	Spool Capacity	Extra Sp.	B.B.
034-20-100	1000	240	5.5:1 (72 cm)	Ø 20 mm - 195 m	1	2+1
034-20-200	2000	260	5.5:1 (75 cm)	Ø 20 mm - 230 m	1	2+1
034-20-300	3000	290	5.2:1 (78 cm)	Ø 25 mm - 215 m	1	2+1
034-20-400	4000	310	5.2:1 (84 cm)	Ø 30 mm - 175 m	1	2+1
034-20-500	5000	330	5.2:1 (88 cm)	Ø 35 mm - 195 m	1	2+1
034-20-600	6000	350	5.2:1 (92 cm)	Ø 45 mm - 140 m	1	2+1

REGENT FA



Wide new family of reels that are good to be used in a variety of techniques, both in fresh and salt water. Despite their gear is supported by a single bearing, the movement is really smooth. We achieved this result using self-lubricating Teflon bushes and a Multistop antireverse. The smallest sizes, like the 1000 and 2000, are very good for light and ultra light spinning, while the 3000 and 4000 sizes are widely used with Bolognese and Bombarda rods. The bigger sizes like 5000 and 6000, thanks to the high capacity of their spools, are perfect for live bait and bottom fishing and for many salt water uses. The reels are pre spooled and they are ready to go as soon as they come out of their box.

FEATURES



Code	Model	Weight	Gear Ratio	Spool Capacity	Extra Sp.	B.B.
033-48-100	1000	240	5.5:1 (72 cm)	Ø 0.18 mm - 215 m	-	1
033-48-200	2000	260	5.5:1 (75 cm)	Ø 0.20 mm - 195m	-	1
033-48-300	3000	290	5.2:1 (78 cm)	Ø 0.25 mm - 245m	-	1
033-48-400	4000	310	5.2:1 (84 cm)	Ø 0.30 mm - 195m	-	1
033-48-500	5000	330	5.2:1 (88 cm)	Ø 0.35 mm - 275m	-	1
033-48-600	6000	350	5.2:1 (92 cm)	Ø 0.45 mm - 195m	-	1

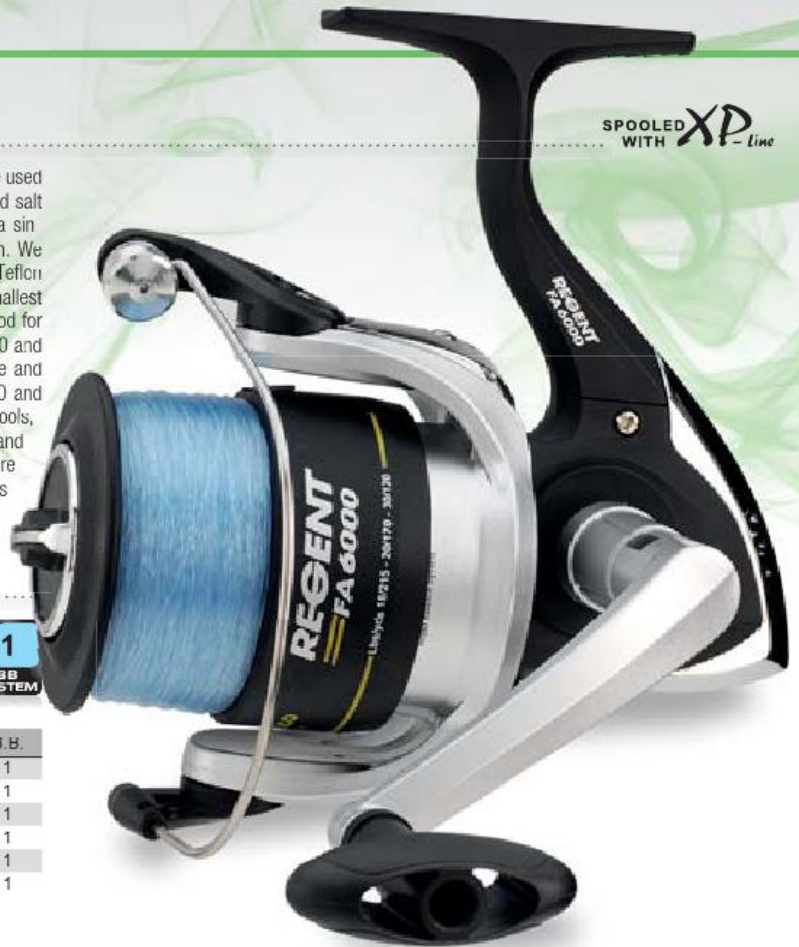

SPOOLED WITH **XP-Line**



AURIS EVO FA



New wide series of reels offering a good solution for style of fishing at a very competitive price. Retrieve is very smooth even if only one ball bearing has been used. This is due to the top quality bushes used instead. Gear ratio has been differentiated, 5.5:1 for smaller sizes, 5.2:1 for bigger, to match the different techniques needs. We improved the handle introducing a new 4 pegs locking system, obtaining a smooth retrieve and preserving gears from use. This series can count on some pre-spooled models as well, available in sizes 3000 and 6000. In this was the anglers has the comfort to buy a ready to go reel and the possibility to see hoe hood these reels spool the line. Not

to mention the possibility to buy at a competitive price both a good reel and a good Trabucco quality line.

FEATURES



Code	Model	Weight	Gear Ratio	Spool Capacity	Extra Sp.	B.B.
033-46-100	1000	240	5.5:1 (72 cm)	Ø 0.18 mm - 215 m	-	1
033-46-200	2000	260	5.5:1 (75 cm)	Ø 0.20 mm - 195 m	-	1
033-46-300	3000	290	5.2:1 (78 cm)	Ø 0.25 mm - 245 m	-	1
033-46-400	4000	310	5.2:1 (84 cm)	Ø 0.30 mm - 195 m	-	1
033-46-500	5000	330	5.2:1 (88 cm)	Ø 0.35 mm - 275 m	-	1
033-46-600	6000	350	5.2:1 (92 cm)	Ø 0.45 mm - 195 m	-	1

Spooled with XP-Line Phantom

033-46-920	2000	260	5.5:1(75cm)	Spooled	-	1
033-46-930	3000	290	5.2:1(78cm)	Spooled	-	1
033-46-960	6000	350	5.2:1(92cm)	Spooled	-	1

SPOOLED WITH **XP-Line**

MITO MICRO FD

Ultra thin shape body, ultralight aluminium spool and strong main gear make this reel the first choice for all the angler who don't accept compromise on quality and reliability. Unrivalled smoothness, and micro-adjustable front drag. Perfect for ultra-light spinning and bolognese. Anti twist line roller will help to preserve the thin monofilament normally used for this discipline.



FEATURES



Code	Model	Weight	Gear Ratio	Spool Capacity	Extra Sp.	B.B.
033-13-100	100	160	5.2:1 (60 cm)	Ø 0.18 mm-165 m	-	4+1

AURIS MICRO



Super light series sold with pre spooled line. The possibility to see this reel already spooled allow the anglers to appreciate the spooling system. Drag is very well calibrated and gear, despite dimensions, is powerful and reliable.

FEATURES



Code	Model	Weight	Gear Ratio	Spool Capacity	Extra Sp.	B.B.
033-44-100	1000	162	5.5:1 (69 cm)	Spooled	-	1



ZEON XT MICRO



This tiny model is designed for ultra-light spinning and is available in one size only. Featuring a stainless steel ball bearing, front micrometric drag, graphite spool, Multistop system and balanced handle with a soft knob. Is perfect for trout fishing, with a light spinning rod and ultra light lures.

FEATURES



Code	Model	Weight	Gear Ratio	Spool Capacity	Extra Sp.	B.B.
031-18-100	100	150	5.5:1 (69 cm)	Ø 0.18 mm - 145 m	-	1

CASTFORCE FEEDER



CASTFORCE FEEDER



Model specially designed for feeder fishing in rivers and large bodies of water. It is a light weight graphite body reel equipped with a long cast machine cut aluminium spool able to spool up to 135 m of 0.35 line. Cranking power is assured by the low ratio 4.9:1 and the quality of the gears and bearings, 6 of the Long Life sort and one way clutch to support the instant anti reverse. The handle too is made of cold forged aluminium to keep the general feeling of power. The Castforce Feeder features a second spare graphite spool, really useful if you use the same reel in very different situations that require different lines spooled. Despite its medium size, this model fights with no problem even against big carp.

ferent situations that require different lines spooled. Despite its medium size, this model fights with no problem even against big carp.

FEATURES



- Graphite body
- Oversized aluminium main spool
- Graphite spare spool
- Line Guard Protector
- Hollow bail with Anti Twist line roller
- Micro-adjustable drag with oversized disks
- Infinite anti-reverse
- Aluminium handle



Code	Model	Weight	Gear Ratio	Spool Capacity	Extra Sp.	B.B.
033-87-500	5000	375	4.9:1 (85cm)	Ø 0.30 mm - 180 m	1	6+1

QOSMIO FEEDER

Feeder fishing is having more and more success all over Europe, both in fresh and salt water. To satisfy the market needs Trabucco is introducing a brand new reel, specifically designed for this high effective and funny technique. The high end quality of the materials used to build the new Qosmio Feeder allow a super smooth and effortless retrieve of the biggest fish. The ratio has been chosen to have enough speed and still enough power. The conical spool allows longer and more accurate casts, preserving the spooled line from stress and granting a longer use and better performance.



FEATURES

- Graphite body
- Oversized aluminium main spool
- Hollow bail with Anti Twist line roller
- Micro-adjustable drag with oversized disks



- Infinite anti-reverse
- Aluminium handle

POWERBAIL

SBS Super Balance System

AS ROLLER ANTI-TWIST SYSTEM

ONEWAY CLUTCH

GXV CROSS WINDER

Code	Model	Weight	Gear Ratio	Spool Capacity	Extra Sp.	B.B.
U33-81-400	4000	300	5.2:1 (85 cm)	Ø 0.25 mm – 250m	-	5+1
U33-81-600	6000	420	5.2:1 (95 cm)	Ø 0.30 mm – 315m	-	5+1



NEW QOSMIO CX FEEDER

The new Trabucco reel for feeder fishing won't certainly go unnoticed. The brand new Qosmio CX Feeder is a 5000 sized reel specifically designed for feeder fishing, considering all the specificities of this technique. The graphite body is compact and light weight, and is equipped with an aluminium spool and handle. We choose to go for an aluminium handle to increase the cranking power, while the spool must be aluminium to allow the use of fine braided lines, as, for instance, the new Trabucco Dyna-Tex Power Silk Feeder Braid. The 5,5:1 gear ratio is fast enough to reduce the retrieving time, very important during the competition, but not enough to go down in cranking power. For all the anglers who prefer to use monofilaments instead of braided, the graphite spare spool will be ok, and they will save some weight too. All the gears are supported by 3+1 Long Life stainless steel bearings.

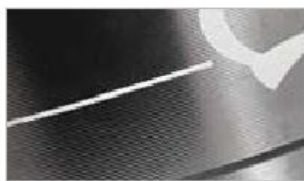

The micro grooves on spool are the signs left by CNC machine. This proves that it has actually been carved from a solid piece of aluminium to obtain extreme resistance.

FEATURES



- Ultra stiff hi-tech graphite body
- CNC aluminium main spool (shallow)
- Graphite extra spool (deep)
- Traditional bail with Anti Twist line roller
- Micro adjustable drag with oversized washers
- Infinite anti-reverse
- Aluminium handle with rubber knob

POWERBAIL

SBS Super Balance System

AS ROLLER ANTI-TWIST SYSTEM

ONEWAY CLUTCH

GXV CROSS WINDER

Code	Model	Weight	Gear Ratio	Spool Capacity	Extra Sp.	B.B.
033-96-550	5500	415	5.5:1 (104 cm)	Ø 20 mm – 200 m	1	3+1



NEW LEGACY RD

Here is the Legacy second edition, a family of reels that confirmed to be able to amaze all the anglers cause of its performance. The amazing look of this reel is just enhancing the great technical value. The gears are super smooth due to the 2+1 stainless steel bearings positioned in the locations suffering the highest friction. Body and balanced rotor are made of light and stiff graphite, to contain the total weight. The stiffness of the graphite is a warranty of a long life of all inner gears. The bail arm is equipped with anti twist line roller, very important for long fishing sessions with no line problems. The main spool is really nice, made of anodized aluminium and corrosion free. The spare spool is super light graphite made. To increase cranking power the Legacy features a cold forged aluminium handle. The great range of models can really satisfy all the needs, from fresh to salt water.

FEATURES



Code	Model	Weight	Gear Ratio	Spool Capacity	Extra Sp.	B.B.
034-21-100	1000	240	5.5:1 (72 cm)	Ø 20 mm – 195 m	1	2+1
034-21-200	2000	260	5.5:1 (75 cm)	Ø 20 mm – 230 m	1	2+1
034-21-300	3000	290	5.2:1 (78 cm)	Ø 25 mm – 215 m	1	2+1
034-21-400	4000	310	5.2:1 (84 cm)	Ø 30 mm – 175 m	1	2+1



AURIS EVO RA

Wide series of reels offering a good solution for style of fishing at a very competitive price. Retrieve is very smooth even if only one ball bearing has been used. This is due to the top quality bushes used instead. Gear ratio has been differentiated, 5.5:1 for smaller sizes, 5.2:1 for bigger, to match the different techniques needs. We improved the handle introducing a new 4 pegs locking system, obtaining a smooth retrieve and preserving gears from use. This series can count on some pre-spooled models as well, available in sizes 2000 and 3000. In this was the anglers has the comfort to buy a ready to go reel and the possibility to see hoe hood these reels spool the line. Not to mention the possibility to buy at a competitive price both a good reel and a good Trabucco quality line.



FEATURES



Code	Model	Weight	Gear Ratio	Spool Capacity	Extra Sp.	B.B.
033-47-100	1000	240	5.5:1 (72 cm)	Ø 0.18 mm - 215 m	-	1
033-47-200	2000	260	5.5:1 (75 cm)	Ø 0.20 mm - 195 m	-	1
033-47-300	3000	290	5.2:1 (78 cm)	Ø 0.25 mm - 245 m	-	1
033-47-400	4000	310	5.2:1 (84 cm)	Ø 0.30 mm - 195 m	-	1

Spooled with XP-Line

033-47-920	2000	260	5.5:1 (75 cm)	Spooled	-	1
033-47-930	3000	290	5.2:1 (75 cm)	Spooled	-	1

SPOOLED WITH **XP-Line**



REGENT RA

SPOOLED WITH **XP-Line**

Wide new family of reels that are good to be used in a variety of techniques, both in fresh and salt water. Despite their gear is supported by a single bearing, the movement is really smooth. We achieved this result using self-lubricating Teflon bushes and a Multistop anti-reverse. The Regent reels are really easy to use and are just perfect to counterbalance very long rods, such as Bolognese and telescopic Match and Bombarda rods as well. The reels are pre spooled and they are ready to go as soon as they come out of their box.

FEATURES



Code	Model	Weight	Gear Ratio	Spool Capacity	Extra Sp.	B.B.
033-49-100	1000	240	5.5:1 (72 cm)	Ø 0.18 mm - 215 m	-	1
033-49-200	2000	260	5.5:1 (75 cm)	Ø 0.20 mm - 195 m	-	1
033-49-300	3000	290	5.2:1 (78 cm)	Ø 0.25 mm - 245 m	-	1
033-49-400	4000	310	5.2:1 (84 cm)	Ø 0.30 mm - 195 m	-	1



MITO MICRO RD



Don't be fooled from the small size of this reel, you can land easily big fish thanks to the micro-adjustable rear drag and to the strength of the main gear. Perfect machine for ultra-light trout fishing in small rivers with small minnow and spinners. Anti twist line roller will

help to preserve the thin monofilament normally used for this discipline.

FEATURES



Code	Model	Weight	Gear Ratio	Spool Capacity	Extra Sp.	B.B.
033-13-200	100	160	5.2:1 (60 cm)	Ø 0.15 mm - 300 m	-	4+1



MARVEL



Gianluigi Sorti

MARVEL CRX

Super smooth reel, whose gears are supported by 9 Long Life Ball Bearing and 1 One Way bearing, equipped with Free Spool System. The drag is the real strong point of Marvel, featuring wider discs and super fine adjusting options. Main spool is made of aluminium, while the second spool is made of graphite. The fighting handle is aluminium machine cut.

FEATURES



Code	Model	Weight	Gear Ratio	Spool Capacity	Extra Sp.	B.B.
033-83-400	4000	392	5.2:1 (82 cm)	Ø 0.30 mm - 200 m	1	9+1
033-83-600	6000	494	5.2:1 (90 cm)	Ø 0.40 mm - 195 m	1	9+1

MARVEL CRS

Super smooth reel, whose gears are supported by 2 Long Life Ball Bearing and 1 One Way bearing, equipped with Free Spool System. The drag is the real strong point of Marvel, featuring wider discs and super fine adjusting options. Main spool is made of aluminium. The fighting handle is aluminium machine cut.

FEATURES



Code	Model	Weight	Gear Ratio	Spool Capacity	Extra Sp.	B.B.
033-82-400	4000	385	5.2:1 (82 cm)	Ø 0.30 mm - 200 m	1	2+1
033-82-600	6000	489	5.2:1 (90 cm)	Ø 0.40 mm - 195 m	1	2+1



Goran Radovic



AURIS BR

SPOOLED WITH **XP-Line**

High quality components encased in a graphite body. Thanks to this features it is extremely lightweight and durable. The Free Runner Trabucco entry level is perfect for those who want to start ledgering or boat fishing session. Quality and warranty for this product are unbeatable in this price range, especially considering a very wide spools that helps keep the line in perfect condition at all times without forming loops. Auris BR is just sold spooled with XP line to allow his spooling features.

FEATURES



Code	Model	Weight	Gear Ratio	Spool Capacity	Extra Sp.	B.B.
033-28-400	4000	320	5.2:1 (82 cm)	Ø 0.30 mm - 180 m	-	1
033-28-500	5000	402	5.2:1 (86 cm)	Ø 0.30 mm - 300 m	-	1
033-28-600	6000	425	5.2:1 (90 cm)	Ø 0.30 mm - 340 m	-	1

AXIS BR



You don't need to pay a fortune for good light weight free runner reel, if it comes from Trabucco, of course. Even if this reel is so light weight, it does not mean it is not strong or reliable enough. On the contrary, this reel is the proof that a good project can exceed market requests. Smooth and well balanced, this reel is good for every fishing style requiring a reliable drag. Axis Br comes already spooled with genuine Trabucco XP-Line Carp 0.35.

ing a reliable drag. Axis Br comes already spooled with genuine Trabucco XP-Line Carp 0.35.

FEATURES

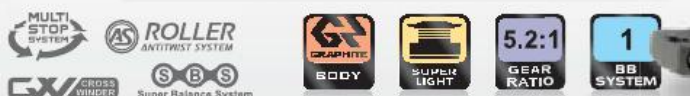

Code	Model	Weight	Gear Ratio	Spool Capacity	Extra Sp.	B.B.
033-29-600	6000	350	5.6:1 (87cm)	Ø 0.40 mm - 160 m	-	1



SPOOLED WITH **XP-Line**

XRIDE



NEW X-RIDE SURF

Not only Trabucco top of the range, but world class reels! X-Ride is a series specially developed for surf casting around a large long cast spool and limited weight to perfectly match nowadays lighter surf rods. The graphite body is particularly thin and elegant, while the spool, made from anodized aluminium, is fitted on to a polymer frame which avoids line slipping down, thus eliminating tangle risks, specially when using fine lines. The aluminium handle is long and swept; gears rotation is assisted by 13 ball bearings, including the large one which drives the infinite anti-reverse. Drag is sealed to avoid salt and sand getting in. Thanks to worm shaft, the line lay is absolutely perfect. The tubular bail is made from aluminium, and is quite strong and light at the same time. The whole reel is protected against corrosion, and ball bearings are double shielded to prevent salt and sand damaging their function. Size 8000 is oriented to light surf, with light weight and a wide, tapered spool (7 cm diameter and 4 cm height), which enables impressive casts even with light leads such as 50 or 75 grams. The new size 10000 is destined to proper surf casting, with a 25% higher spool to obtain a wider angle in lines distribution, which means that friction between line coils is reduced during the cast. Both reels are equipped with cast lock system to avoid incidental closure, so that the bail arm can be closed manually only.

Code	Model	Weight	Gear Ratio	Spool Capacity	Extra Sp.	B.B.
035-06-080	8000	625	4.6:1 (94 cm)	Ø 0.32 mm - 320 m	-	12+1
035-06-100	10000	750	4.5:1 (97 cm)	Ø 0.35 mm - 270 m	-	12+1 NEW
035-06-081	Long Cast Spare Spool 8000					
035-06-101	Long Cast Spare Spool 10000					



The 8000 and 10000 spools differ in length. The 10000 is recommended in case thick lines are spooled, because the coils form a wider angle.



On left, the standard ball bearings are open to get salt within balls. On right, the shielded version from X-Ride series is safe from aggressive agents.



Thanks to its special design, the worm shaft is responsible of perfect line lay on reel's spool. As a consequence, the casting distance is improved, due to easier line flow.

FEATURES

- Hi-Tech graphite body and rotor
- Ultralight aluminium long cast spool
- Hollow bail with titanium Anti Twist line roller
- Double Shielded SS Long Life Ball Bearings
- Saltwater & Dust Proof Drag
- Infinite Antireverse
- Stainless Steel main shaft
- Worm Shaft for a perfect line lay
- Bail arm lock system (manual closure only)
- Machined aluminium handle with rubber knob



LANCER SURF

NEW LANCER SURF

The Lancer Surf is a great surf casting reel made of super stiff, light weight graphite, whose overall weight is only 700 g. The oscillation system spools the line perfectly and it is super slow, lowering the stress to the line. The super slow oscillation system together with the worm shaft gear are the perfect solution for a perfect line lay that is key for long casts. The super tapered spool is designed for long casting as well. The Lancer Surf is not only a reel casting like a cannon, it is a powerful reel too, due to the low 4.3:1 ratio gears and the aluminium fighting handle. The crushproof tubular aluminium bail arm is equipped with a blocking system that prevents casual closing. The closing is just by hand. The new drag is the special Fast Play Drag, so with only one drag turn, the spool goes from totally blocked to totally free. This solution is useful when you need to give line rapidly or when you need to hang on the line the bite detectors. The 6+1 Long Life bearings are stainless steel and salt water proof. A second aluminium spool can be purchased separately at a really affordable price.



Code	Model	Weight	Gear Ratio	Spool Capacity	Extra Sp.	B.B.
035-14-800	8000	700	4.3:1 (92 cm)	Ø 0.30 mm - 260 m	-	6+1
035-14-801	Aluminium Spare Spool					



By just half a turn of drag knob, the drag is completely loose or totally fastened.



Light and strong aluminium tubular bail, with anti-twist line roller.



Thanks to its special design, the worm shaft is responsible of perfect line lay.



Power and smoothness thanks to the multi-disk drag (steel and PTFE coated disks).

FEATURES

- Hi-Tech graphite body and rotor
- Ultralight aluminium Longcast spool
- Hollow bail with titanium Anti Twist line roller
- Stainless steel Long Life Ball Bearings
- Sealed drag, with PTFE coated disks
- Infinite Antireverse
- Worm Shaft for a perfect line lay
- Bail arm lock system (manual closure only)
- Stainless Steel main shaft



POWERBAIL

STAINLESS STEEL COMPONENTS

AVS ANTI-TWIST SYSTEM

ROLLER ANTI-TWIST SYSTEM

ONE WAY CLUTCH

SOS SLOW OSCILLATION SYSTEM

WORM SHAFT GEAR

XENOS



Emiliano Tenerelli

XENOS LDX

Japanese designed high performance reel, made precious by several technical solutions that increase the fishing experience with it. Graphite body is light weight but robust, while the aluminium fighting handle features a large knob that is very comfortable. Long cast cold forged aluminium spool is conical shaped and together with the perfect worm shaft line lay, grants the longer casts possible. Drag system is sealed to preserve

its integrity from salt water and sand, so it can be always ready when needed. Graphite spare spool. Additional aluminium spare spool can be purchased separately at a very competitive price.

FEATURES



- Hi-Tech graphite body and rotor
- Ultralight aluminium easy cast spool
- Graphite extra spool
- Hollow bail with titanium Anti Twist line roller
- Rotary Flat Oscillation System
- Double Shielded SS Long Life Ball Bearings
- Saltwater & Dust Proof Drag
- Infinite Antireverse
- Worm Shaft for a perfect line lay
- Stainless Steel main shaft
- Bail arm lock system (manual closure only)



Hidden in the body's hearth, there is an important part of Xenos LDX. Thanks to its special design, the worm shaft is responsible of perfect line lay on reel's spool. As a consequence, the casting distance is improved, due to easier line flow.



The titanium line roller is linked to bail arm with a tapered sleeve which drives the line to roller, even when tension is very low.



Code	Model	Weight	Gear Ratio	Spool Capacity	Extra Sp.	B.B.
035-10-100	10000	700	3.9:1 (90cm)	Ø 0.30 mm - 385 m	1	5+1
035-10-101	Easy Cast Spare Spool					



On left, the standard ball bearings are open to get salt within balls. On right, the shielded version fitted on Xenos LDX series is safe from aggressive agents.

XENOS SURF POWER

Japanese project, Italian Design. Carefully finished in every detail, the Xenos family is synonymous of reliability and long lasting quality. The proof is the Xenos family producing new models year after year. The new Power Surf it is actually a powerful reel with all a rugged reel should have and nothing more. The graphite body is very stiff, to preserve gears, and the aluminium handle is one touch for best storing. The graphite spool is conical to help line to exit during casting and to get longer distances. 5 stainless steel saltwater proof ball bearings and a one way clutch support the gears. The bail arm is hollow, lighter but way more resistant. Additional spare spools can be eventually purchased at a very competitive price.



One touch is enough to fold the handle arm, thus reducing the reel's volume to easily store the rod into the holdall.

FEATURES



- Graphite body and rotor
- Graphite Longcast spool
- Traditional bail with Anti Twist line roller
- Double Shielded SS Long Life Ball Bearings
- Saltwater & Dust Proof Drag
- Infinite Antireverse
- Rotary Flat Oscillation System
- Stainless Steel main shaft
- Aluminium one touch folding handle

POWERBAIL



Code	Model	Weight	Gear Ratio	Spool Capacity	Extra Sp.	B.B.
035-12-100	10000	630	3.9:1 (90cm)	Ø 0.30 mm - 385 m	1	5+1
035-12-101	Lightweight Graphite Spare Spool					

NEW CASTFORCE PRO SURF

The Castforce Pro Surf is a long casting reel offered at a very nice price but designed and equipped as more expensive models. The cold forged aluminium Long Cast spool features a smart system preventing the line to go under the skirt. Body and rotor are graphite made, the aluminium is machined cut aluminium and finished with a fighting knob. The tubular aluminium bail arm is crushproof. Since many anglers are into competitions, we decided to add a spare graphite spool that can be spooled with a different diameter line, to be used in different weather conditions. The 6+1 Long Life stainless steel bearings are salt water treated.

FEATURES



POWERBAIL



Code	Model	Weight	Gear Ratio	Spool Capacity	Extra Sp.	B.B.
035-09-080	8000	660	4.1:1 (82 cm)	Ø 0.40 mm - 220 m	1	6+1



MAXXIS



NEW MAXXIS HYPER SURF

With a complete saltwater protection and sealed ball bearings, it's well prepared to face the tough life at sea side, its true vocation. But it's not just that: the new series Maxxis Hyper Surf offers a lot more, starting from a perfect volume's ratio which is based on a compact body and large spool, destined to smoothly handle the line with its wide diameter, tapered profile and slim lip. The worm shaft is behind a clean line lay, and the job is done with slower than standard oscillation; the best way to provide a quick, neat and trouble free cast is to regularly wind the line onto the spool, and in this sense Maxxis doesn't fear the comparison to the rest of surf casting reels. The aluminium handle is nicely swept to keep its barycentre as close as possible to body's axis, thus limiting the oscillations during the retrieve. With such list of technical specifications, everybody would expect an high price, but this is surely going to shock the whole beach community.

FEATURES



- X-Tra Tough graphite body
- Longcast aluminium spool
- Longcast aluminium spare spool
- Traditional bail with Anti-Twist line roller
- Sealed stainless steel ball bearings
- Infinite antireverse
- Worm Shaft for a perfect line lay
- Aluminium handle with ergonomic rubber knob



Code	Model	Weight	Gear Ratio	Spool Capacity	Extra Sp.	B.B.
035-15-080	8000	610	4.5:1 (98 cm)	Ø 0.35 mm - 220 m	1	3+1
035-15-100	10000	735	4.5:1 (98 cm)	Ø 0.40 mm - 220 m	1	3+1

MAXXIS PRO SURF

This is a Big "Free Runner" with a fast drag release located on the spool. With this new device the drag and the extra drag features are adjustable independently. The result is a truly micrometric adjustment system that allows you to switch from "free running" to normal use by turning the drag knob by just half a turn. Equipped with four stainless steel ball bearings and sealed by a salt-proof special treatment the Maxxis Pro Surf incorporates an infinite anti-reverse roller bearing. Other features include anti-tangle, flow concept bail mechanism and worm shaft for perfect cross spool winding, fighting ergonomic handle (turned from solid) plus, super hard alloy graphite body, low capacity spool. All these outstanding features make this reel perfect for surf-casting.



FAST PLAY DRAG - Drag system featuring a dual-presetting mode that incorporates in a single device all free runner drag facilities. It acts directly into the spool, allowing to have a more direct, progressive and fine tuning drag system. The free spool setting is regulated by the inner knob, while to switch to combat drag half turning the main drag knob is enough.



On left, the standard ball bearings are open to get salt within balls. On right, the shielded version from Maxxis Pro Surf series is totally safe from aggressive agents.

FEATURES



- Hi-Tech graphite body and rotor
- Aluminium Longcast spool
- Traditional bail with Anti Twist line roller
- Shielded SS Long Life Ball Bearings
- Infinite Antireverse
- Worm Shaft for a perfect line lay
- Machined aluminium handle with oversized knob



Code	Model	Weight	Gear Ratio	Spool Capacity	Extra Sp.	B.B.
032-77-650	8000	578	4.8:1 (98 cm)	Ø 0.25 mm - 260 m	1	5+1
032-77-750	10000	724	4.3:1 (104 cm)	Ø 0.35 mm - 240 m	1	5+1
032-77-651	Maxxis Pro Surf 8000 Spare Spool					
032-77-751	Maxxis Pro Surf 10000 Spare Spool					

HyronCast



NEW HYRONCAST

Compact and powerful, the Hyroncast is for sure one of the most powerful reels you can use from the beach and the boat. The graphite body holds a powerful gear with a quite fast ratio gear of 4.9:1 and a number of features that many beach casters will appreciate, as the worm shaft gear for a perfect line lay and a tapered aluminium spool. A perfect line lay is the best start to get a long cast. A second graphite spool comes into the box. A so powerful gear is supported by a fighting handle, made of machine cut aluminium. All the 6+1 Long Life bearings are stainless steel and salt water protected.



Aluminium Power Bail with specially shaped Anti Twist line roller.



Thanks to its special design, the worm shaft is responsible of perfect line lay on reel's spool, with neat angles between each coils. As a consequence, the casting distance is damatically improved, due to easier line flow.

FEATURES



Code	Model	Weight	Gear Ratio	Spool Capacity	Extra Sp.	B. B.
035-05-550	5500	570	4.9:1 (97 cm)	Ø 0.25 mm - 310 m	1	6+1
035-05-650	6500	550	4.9:1 (97 cm)	Ø 0.30 mm - 390 m	1	6+1
035-05-800	8000	770	4.7:1 (103 cm)	Ø 0.35 mm - 330 m	1	6+1



Giuseppe Alessi

KRONOS

KRONOS PRO SURF



When you need a powerful retrieve and expect reliability without frills, the nit is the time for rugged, plain and efficacious reels, such as the new Kronos Pro Surf. An extra strong graphite body combined with an aluminium forged long cast spool and a powerful drag, featuring oversized discs, able to face whatever difficult situation on the shore. The weight is light, so you can couple this reel even with light surf rods, but still a very good choice cause of the casting skills. Gears are smooth thanks to 6 Long Life ball bearings and one way clutch. The aluminium handle is long and making a good lever when retrieving heavy preys. This reel comes with spare graphite spool.



FEATURES



Code	Model	Weight	Gear Ratio	Spool Capacity	Extra Sp.	B.B.
U33-38-100	8000	755	4.7:1 (100cm)	Ø 0,30mm - 450m	1	6+1



KRONOS SW



The Kronos Surf Casting reels family is now bigger as we introduced two new reels, the SW models, designed for Beach Casting with medium weight leads, around 75-125 g. These two models, 6000 and 8000 size, have a compact body and are light weight, being entirely made of corrosion resistant graphite. Main spool is aluminium, the spare one in polymer. The aluminium handle is very nice and features an high density ergonomic EVA fighting knob. The ratio of 4.9:1 for both models grants a lot of cranking power. Despite the small body the Kronos Surf SW

spools are really wide, being able to be filled with close to 500m of 0.20 (SW 6000) or close to 400m of 0.30 (SW 8000).

FEATURES



Code	Model	Weight	Gear Ratio	Spool Capacity	Extra Sp.	B.B.
033-39-600	6000	551	4.9:1 (92 cm)	Ø 0.20 mm - 490 m	1	6+1
033-39-800	8000	536	4.9:1 (98 cm)	Ø 0.30 mm - 390 m	1	6+1



HORNET xTC

High capacity and super reliable surf casting reel featuring first quality equipment. The wide conical aluminium spool has a capacity of 450 meters of 0.30 and its profile helps to increase the casting distance. The reel has a second graphite spool as well. The spooling is perfect thanks to the Worm Shaft gear and the slow oscillation system SOS. Gears are really smooth thanks to 6 stainless steel salt water resistant ball bearing and the one way bearing.



The line clip is round and is assisted by a spring in order to avoid any line damage.

FEATURES



Code	Model	Weight	Gear Ratio	Spool Capacity	Extra Sp.	B.B.
033-84-990	10000	755	4.7:1 (105 cm)	Ø 0.30 mm - 480 m	1	6+1



ALIOTH SURF

Series of surf casting reels featuring very good performance for a very interesting price point. The body is graphite made, to stay light weight, while the spool and the handle are made of cold forged aluminium to give power. The wide diameter spool is perfect for long casting, together with the perfect line lay given by the worm shaft system. The line is always safe cause it will pass through an anti twist roller guide line. Gears are supported by 4 ball bearing and one way clutch. The drag has oversized discs and it is sealed to protect it against salt water and sand. Two sizes available, 8000 and 10000, to meet different needs throughout Europe.

Code	Model	Weight	Gear Ratio	Spool Capacity	Extra Sp.	B.B.
035-02-080	8000	582	4.8:1 (98 cm)	Ø 0.25 mm - 260 m	-	4+1
035-02-100	10000	693	4.3:1 (104 cm)	Ø 0.35 mm - 240 m	-	4+1

FEATURES



POWERBAIL



NEW ANDROMEDA LONG CAST

Medium priced Surf Casting reel that despite the price offers a wide choice of specs that normally you can find only in more expensive models. We have here a wide ultra light graphite conical spool, absolutely necessary for long casting, and a perfect cross line spooling thanks to the Worm Shaft System. Both these solutions grant you long distance and no problems with your line. The slow oscillation gears help to keep the line healthy for a long long time, so you will not need to change it that often. One Touch foldable handle and 4+1 salt water protected bearing will make all your retrieves really smooth.



FEATURES

Code	Model	Weight	Gear Ratio	Spool Capacity	Extra Sp.	B.B.
033-37-990	10000	720	4.7:1 (100 cm)	Ø 0.45 mm - 300 m	-	4+1



NEW SEARIDER NRG SURF

New series of reels designed for bottom salt water fishing, from the shores, the rocks or piers. The Searider NRG Surf has been initially conceived for surf casting from sandy beaches, but thanks to its versatility and the possibility to choose between 2 sizes, it can be used in more situations. The 8000 is perfect for surf casting and live bait fishing from the rocks, searching for the big bluefish. The 6500 is a very good compromise between light weight and power for Beach Legering technique.

FEATURES

Code	Model	Weight	Gear Ratio	Spool Capacity	Extra Sp.	B.B.
033-34-650	6500	510	4.9:1 (92 cm)	Ø 0.25 mm - 300 m	-	4+1
033-34-800	8000	515	4.9:1 (98 cm)	Ø 0.35 mm - 370 m	-	4+1

OCEANIC SURF

This reel has been designed for anglers that face the Surf Casting technique for the first time. The low price should not mislead you, because the Oceanic Surf features a perfect spooling with crossing line system. We decided to sell this reel pre spooled with Trabucco XP Line, to make you know this very good line too, very good specially for Surf Casting. The graphite conical spool will help you for sure to attain very long casts.

FEATURES



Code	Model	Weight	Gear Ratio	Spool Capacity	Extra Sp.	B.B.
033-43-100	8000	613	4.1:1 (91 cm)	Ø 0.40 mm - 250 m	-	1



Emiliano Tenerelli



AVALON PRO SURF



The Avalon Surf is offered to an affordable price and designed for those who want to take their first steps in the surf techniques. It shows an elegant cosmetics with an ultra reliable mechanics. Fitted with only one ball bearing but definitely well designed and assembled, it delivers a great smoothness and a good retrieve power ideal for the surfcaster. The size 6500 is ideal to be combined with telescopic rods and a gear ratio of 4.1:1 but still delivers a good line covering. Extremely lightweight despite the size, Avalon Surf features a graphite body and spool, the AS line roller, super balance system and the power handle ends with a soft ergonomic knob. Available in two colors (Red and Blue) for an elegant combination with Avalon rods.

FEATURES



Code	Model	Weight	Gear Ratio	Spool Capacity	Extra Sp.	B.B.
U33-42-100	6500	620	4.1:1 (82 cm)	Ø 0.40 mm - 200 m	-	1
U33-42-200	6500	620	4.1:1 (82 cm)	Ø 0.40 mm - 200 m	-	1

EXCEED

Top saltwater game spinning reel. Exceed series is designed for extreme fishing, as tropical popping, deep speed jigging and heavy spinning, from the boat and from the shore as well.

Reels born not to accept any compromise, a perfect combination of cutting edge technology and performance.



EXCEEDING YOUR EXPECTATIONS!

EMOTION

Salt water spinning, from the boat targeting blue tuna hunting in schools, or other noble and pugnacious species is absolutely a serious affair, not leaving any chance to improvisation or last minute equipment. It is key to use reels casting at greater distance, able to face longer than 1 meter fishes, made of powerful muscles, light enough not tire the casting anglers even after several hours of fishing. And it is key as well to know you can count on them in very instant of the fight, you can count on every single screw! And it is essential the drag can stand such a fight, being able to turn the head of the prey in the right direction when the moment is come, even if the line is whizzing through the guides and the rod blank is creaking. Who tried this perfectly knows what we mean. And knows this strong emotion can become obsession and reason of life. And finally knows he needs an Exceed reel!



POWERBAIL **STAINLESS STEEL COMPONENTS**

**Ai-Si
Cu-Mg**
ALUMINIUM
BODY

SWR
SALT WATER
RESISTANT

10+1 SS
SHIELDED
BEARINGS

30Kg
MAX
DRAG

FULL METAL BODY

The whole body of an Extreme reel is made of metallic alloy and aluminium, extremely resistant but lightweight materials, only 855 gr for the big 10000, a real winch for legendary trophy fishes.

The whole oversized precision gears are made of rugged premium quality materials as well and are absolutely reliable: stainless steel drive gear, manganese/bronze alloy oscillation gear, stainless steel pinion and main axis. Positive Screw Lock handle, directly self locking into main gear. 4 mm solid aluminium bail arm. Bronze alloy drag knob and clicker. Nothing is left to chance.

The main image shows a fisherman in a dark jacket and cap, holding a large, fresh blue fish (likely a tuna) vertically. The fish's mouth is open, showing its teeth. To the right, a silver and blue fishing reel is prominently displayed. The reel has 'EXCEED 8000 SPIN' and 'SWR' branding. Below the reel, there are several technical specifications in a grid format:

METAL BODY	SWR SALTWATER RESISTANT
6+1 SS SHIELDED BEARINGS	20Kg MAX DRAG

Below the specifications, there are two inset images: one showing a close-up of the reel's handle and another showing a close-up of the reel's internal components, including the bearings and the drag system.

DRAG & MAX DRAG

Exceed spool is a masterpiece of engineering: made of combination of aluminium and carbon to reduce total weight without compromising the overall strength. It is supported by two big stainless steel shielded bearings positioned on the main axis. The powerful drag is made of alternate carbon and stainless steel discs insuring a Max Drag of 30 Kg for all sizes (20 Kg on Salt Water Spin series), strong enough to stop, if you can!, the violent escape of big predators, such as a big GT or a Dogtooth Tuna, searching for shelter between some submerged sharp reef to cut the leader. Despite such a power it is possible to set it with great accuracy, throughout the whole scale. Capacity of the spool of each model has been designed carefully for that model only.



DESTINATION SALT WATER

Evidently designed for salt water use, Exceed reels feature sealed body and drag, 10 shielded stainless steel bearings, one of them made of metaformaldehyde supporting the titanium line roller. It is for sure the bearing the more exposed to water and to heat generated by friction and so needed an extraordinary care to choose the right material. Body features a special lubrication port designed to lubricate gears. All metal parts have been treated against salt water and all aluminium parts have been anodized to prevent corrosion. The anti reverse is permanent for safety reasons and it is supported by a one way stainless steel roller and a recovery stainless steel anti reverse pawl. 4.1:1 gear ratio gives the correct fighting power to fight against the strongest salt water predators, such as bluefin tuna and big GT. Exceed is the perfect reel for the heaviest spinning in Mediterranean Sea, deep vertical jigging and popping into tropical oceans. Dedicated to fanatics searching for strong excitement!

EXCEED SW



Since years the Exceed SW has been taken as example of the best reel in its category for heavy fishing from the boat. It has become so popular you can even find some models that tries to imitate it! All these imitations usually fail their attempt because always lacking of something, that is essentially the quality. And despite a lower quality they are even more expensive, without any technical motivation. All this could be enough to feel proud of ourselves, to have believed since the beginning to the possibility to build a superior quality reel at a price that can be defined reasonable and that everybody can buy. After a so long time from his first launch on the market, the Exceed SW continues to find the favour of anglers and the glory of numerous fishing reports thanks to its great strength, reliability and endurance. It has been used fishing with heavy metal jigs, and so it went under strong and continuous stress; it has been used for Bluefin tuna spinning, and it never gave any signal of failure; finally it has been taken to vacation in the tropical seas, where suffered the worst treatment you can imagine, for days and days. Not a single one of these experiences ever harmed it, or just dip into its "skin" (by the way it's "skin", or to better say its body, is made of a noble alloy made of Aluminum, Silica, Copper and Magnesium). If you don't like compromises forget the rest and just fish with an Exceed SW!

FEATURES



- Stainless Steel Drive gears, Pinion gear & Oscillation-Pinion gear
- Max drag 30 Kg (66lb)
- Gear box lubrication port / hole
- Al-Si-Cu-Mg Aluminium alloy body / rotor / bail arm assembly
- Manganese bronze alloy oscillation gear
- Non reversible LARGE one-way bearing (permanent one-way)
- Stainless steel backup anti reverse pawl
- Positive-Screw-lock CNC handle & knob
- Twin Ball bearing spool (for high speed drag runs)
- Stainless steel and carbon textile drag washers, fine adjustment from full release to full lock with super smooth all the way
- Fully sealed Body & Drag (100% water proof reel)
- No rust Polyester (Metatormaldehyde) Bearing line level pulley
- Titanium Line roller
- Solid 4mm bail wire
- All Stainless steel alloy for all other metal components
- 10+1 S. S. shielded bearings
- Gear ratio 4.1:1



STAINLESS STEEL COMPONENTS

POWERBAIL

Code	Model	Weight	Gear Ratio	Spool Capacity	Max Drag	B.B.
032-67-700	7000	763	4.1:1 (88 cm)	40 lb - 300 m	30kg	10+1 SS
032-67-800	8000	845	4.1:1 (95 cm)	50 lb - 490 m	30kg	10+1 SS
032-67-990	10000	855	4.1:1 (101 cm)	50 lb - 570 m	30kg	10+1 SS

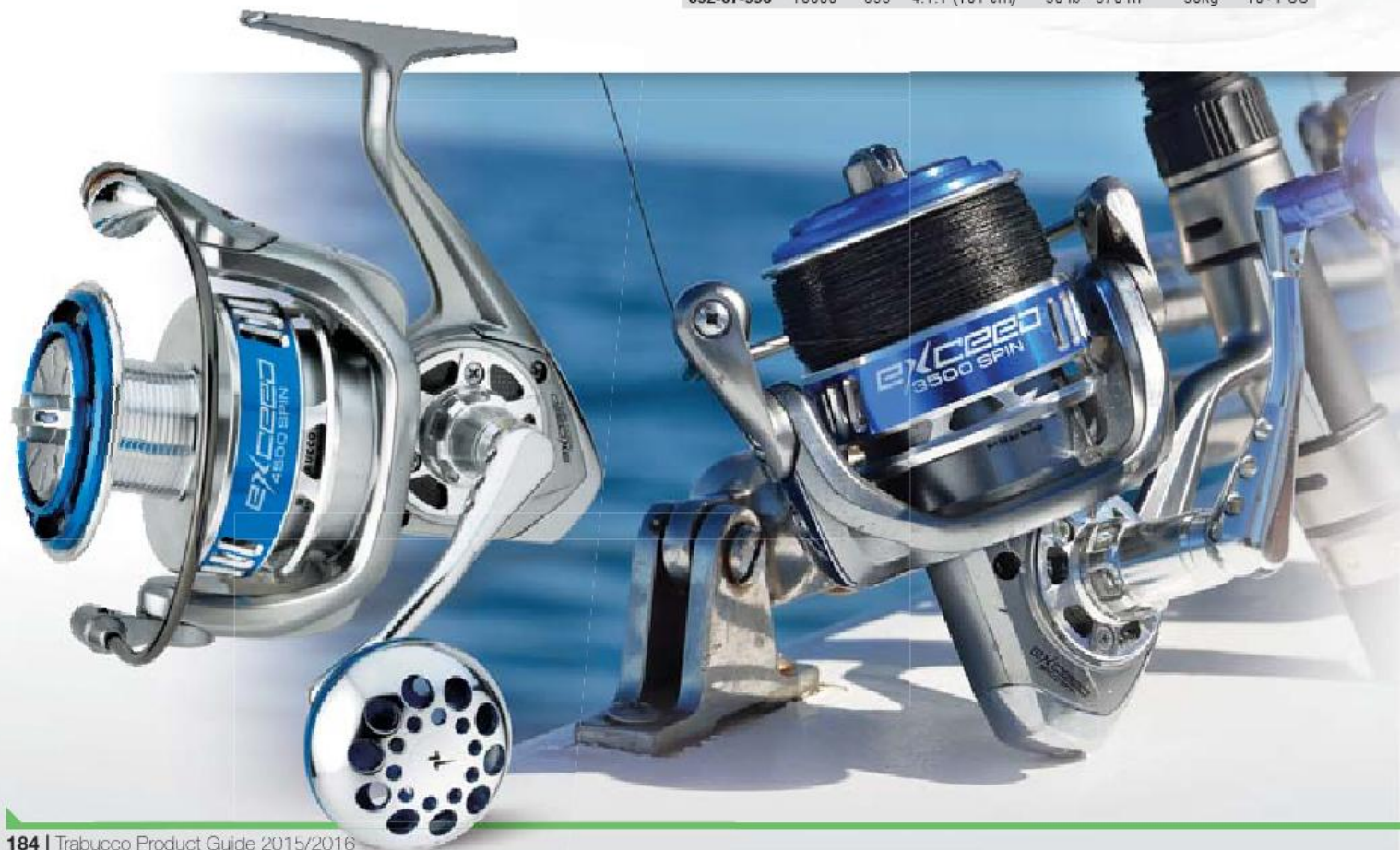

NEW EXCEED SW-H

Three years already passed since the launch of the very first Exceed reel, and still it is one of the most requested. And it could not be otherwise since this reel is offering incredible performance and at an incredible price. In this 3 years some thing changed and also the fishing tackle world have seen major changes. Actually, more and more, people are fishing the bluefin tuna casting medium sized metal jigs. And people started to ask for specific reels for this sporting technique. The new Exceed SW 5500 H has been designed to satisfy the needs of this peupe, featuring a 4.9:1 high speed ratio to allow a perfect retrieve of the metal jigs and a smaller, but not weaker body. Body and rotor are made of the same alloy (Al-Si-Cu-Mg) and sealed with a rubber o-ring. The 10+1 bearings are reinforced, double shielded and stainless steel. The Max Drag is 20 Kg. The new designed handle is a great addition: it is made of stainless steel and designed to be absolutely strong and reliable. The Exceed 5500 SW H is also a light weight reel, only 520g, cause it must be used for long times, but also as powerful as a tuna reel must be.

FEATURES



- Stainless Steel Drive gears, Pinion gear & Oscillation-Pinion gear
- Max drag 20 Kg (44lb)
- Gear box lubrication port / hole
- Al-Si-Cu-Mg Aluminium alloy body / rotor / bail arm assembly
- Manganese bronze alloy oscillation gear
- Non reversible large one-way bearing (permanent one-way)
- Stainless steel backup anti reverse pawl
- Positive-Screw-lock CNC handle & knob
- Twin Ball bearing spool (for high speed drag runs)
- Titanium Line roller
- Solid 4mm bail wire
- Stainless steel and carbon textile drag washers, fine adjustment from full release to full lock with super smooth all the way
- Fully sealed Body & Drag (100% water proof reel)
- No rust Polyester (Metaformaldehyde) Bearing line level pulley
- All Stainless steel alloy for all other metal components
- 10+1 Stainless steel shielded bearings
- Gear ratio 4.1:1

Code	Model	Weight	Gear Ratio	Spool Capacity	Max Drag	B.B.
032-67-500	5500H	520	4.9:1 (87 cm)	Ø 0.33 mm -200 m	20 kg	10+1 SS



STAINLESS STEEL COMPONENTS
POWERBAIL

PE LINE CAPACITIES

- PE #3 - 280m
- PE #4 - 200m
- PE #5 - 160m

EXCEED SPIN

Strong excitement and epic battles with huge fish as well, are not at all exclusive to tropical boat fishing. Fishing from the shore, and often absolutely from the shore, that big fish, the dream of our life just escapes! Cause of a sharp rock or cause of a malicious wave... And that happens just because people is not equipped in the correct way... cause a normal equipment simply cannot stand a dream of a fish! That's why the Exceed Spin was born. Rugged aluminium body, light weight but as tough as iron, less than 500 gr for a 4000 size and still able to spool up to 220 meters of 0.40 line. Anti reverse is permanent with a recovery stainless steel anti reverse pawl to prevent accidents. The fighting handle is fully made of forged aluminium, including the beautiful knob. Drag is absolutely one of a kind and never seen before on reels of the same category of Exceed Salt Water Spin, featuring a 20 Kg Max Drag. An absurd specification for some people but an absolute need for other, ambitious, people.

Premium specs also for the stainless steel gears, the bronze pinion salt water protected and the titanium line roller. Line lay is perfect preventing digging for braided lines and so avoiding dangerous situation when fighting with a big fish. Bailarm is hollow, strong, reliable and lighter than conventional bailarms. Every single part is functional to extreme predators fishing.

Code	Model	Weight	Gear Ratio	Spool Capacity	Max Drag	B.B.
032-68-350	3500	348	5.2:1 (85cm)	Ø 0.30 mm - 210 m	12 kg	6+1 SS
032-68-400	4000	480	5.5:1 (105cm)	Ø 0.40 mm - 220 m	20 kg	6+1 SS
032-68-450	4500	480	5.5:1 (105cm)	Ø 0.40 mm - 280 m	20 kg	6+1 SS
032-68-500	5000	596	4.2:1 (91cm)	Ø 0.50 mm - 260 m	20 kg	6+1 SS
032-68-600	6000	596	4.2:1 (91cm)	Ø 0.50 mm - 350 m	20 kg	6+1 SS

FEATURES

- Stainless Steel Oversized Main Shaft
- Stainless Steel Core Drive Gears with non-rust brass Pinion Gear
- Heavy Duty non-rust Alloy Oscillation Gear
- All Stainless Steel Alloy for all other metal components
- 6+1 Stainless Steel Shielded Ball Bearings
- Max Power Drag 20kg (44lb) - 12Kg for 3500 size
- Aluminum Alloy Body / Rotor & Bail Arm Assembly and Bail Holder
- Non reversible large one-way bearing
- Stainless steel backup anti reverse pawl
- Positive-Screw-lock CNC handle & knob
- Stainless steel and carbon textile drag washers, fine adjustment from full release to full lock with super smooth all the way
- Fully sealed Drag (100% Water & Dust Proof drag washers)
- Solid Power Bail 3.3mm wire
- No rust Metaformaldehyde Bearing line level pulley
- AS Titanium Line roller (Anti-Twist)
- Twin Ball bearing spool



STAINLESS STEEL COMPONENTS

POWERBAIL

X-PLORE SW-H



NEW X-PLORE SW-H

The original design that led us to the production of the very good Xplore reels has been taken to the max using powerful materials to create a new super reel, the new Xplore SW. This strong, powerful reels features a small sized, light weight body entirely made of aluminium. Actually both body and rotor has been made of reinforced aluminium alloy, so the gears can be protected inside this kind of ultra resistant shield. The wide diameter spools, made of aluminium, has been equipped with a titanium lip, to decrease the friction of the line. Also the power handle is made of aluminium, and finished with a fighting knob. The 7+1 bearings are stainless steel, double shielded and salt water proof, so nothing can get in. Two different version of this reel are available: a size 6000, just 470 g and a ratio of 5.9:1, just perfect for salt water spinning, both from the boat and from the shore; a size 7000, 490g, gear ratio 4.9:1 that is intended for light drifting, jigging and bottom fishing.

FEATURES

-
-
-
-
-
-
-
-
-
-
-
-

Code	Model	Weight	Gear Ratio	Spool Capacity	Max Drag	B.B.
033-99-600	6000H	470	5.9:1 (100 cm)	Ø 0.35 mm - 330 m	20 kg	7+1
033-99-700	7000H	490	4.9:1 (95 cm)	Ø 0.40 mm - 330 m	20 kg	7+1
033-99-601	Spare Spool 6000H					
033-99-701	Spare Spool 7000H					



On left, the standard ball bearings are open to get water and salt within balls. On right, the shielded version is totally safe from aggressive agents.



The holes on spool's skirt play the double role to make it lighter and definitely nice.



The upper lip of the spool is remarkably thin and "V" shaped to limit the line friction as much as possible, allowing to get longer casting distances (V Spool Design).



The drag system is sealed and include steel and carbon disks.

SWAT xs

The Trabucco team is developing since years a sophisticated project that gave birth to reels of absolute value such as the Exceed SW and the Exceed Spin. Of course many project has been carried at the same time and after the birth of the first two (the Exceed families), the third one is ready to go now. It is the aggressive Swat XS, a front drag spinning reel for strong emotions, rugged and tough, as in the same tradition that the Exceeds, but also easy to use and really enjoyable. We bet so many people will fall in love of this "gentle war machine"! We are not presenting an allround reel family, good always and everywhere, but a true cranking machine that inside a relatively small and light weight body hides a powerful gears heart. Swat XS gears actually originate from Exceed gears and so they are super reliable in extreme conditions, from medium to big inshore (and fresh water too!) fish to offshore monsters. When using a Swat you must never surrender your wildest dreams!!!

FEATURES



STAINLESS STEEL COMPONENTS

POWERBAIL

GX CROSS WINDER

AS ROLLER ANTI-TWIST SYSTEM

Code	Model	Weight	Gear Ratio	Spool Capacity	Max Drag	B.B.
032-51-350	3500	345	5.2:1 (85cm)	Ø 0.30 mm - 340 m	12 kg	6+1
032-51-400	4000	490	5.5:1 (105cm)	Ø 0.40 mm - 220 m	15 kg	6+1
032-51-500	5000	480	5.5:1 (105cm)	Ø 0.40 mm - 280 m	15 kg	6+1
032-51-600	6000	629	4.2:1 (91cm)	Ø 0.50 mm - 260 m	17 kg	6+1
032-51-700	7000	607	4.2:1 (91cm)	Ø 0.50 mm - 350 m	17 kg	6+1
032-51-351	Spare Spool 3500					
032-51-401	Spare Spool 4000					
032-51-501	Spare Spool 5000					
032-51-601	Spare Spool 6000					
032-51-701	Spare Spool 7000					

NITRO PG

Boat fishing reel, specifically designed for light drifting and speed jigging. Super tough thanks to the full metal body, carefully protecting inner gears. Smooth retrieve through 5 double shielded stainless steel bearings and the one way clutch. Key feature is the powerful drag, with a 15 kilos test, able to face big and fast salt water predators. Rotor, spool and handle made of cold forged aluminium.



Enormous cranking power with no play nor vibrations, thanks to the handle directly connected to drive gear.



Drag system is based on steel and carbon disks to develop huge power and disperse heat at the same time.

FEATURES



ONE WAY CLUTCH

POWERBAIL

AVS

GX CROSS WINDER

AS ROLLER ANTI-TWIST SYSTEM

Code	Model	Weight	Gear Ratio	Spool Capacity	Bob.Extra	B.B.
032-72-700	7000	600	5.0:1 (100cm)	Ø 0.50 mm - 240 m	-	5+1



AIR BLADE POWER SW



NEW AIRBLADE POWER SW

Trabucco team is investing more and more into new technologies and design that can add value to his reels, to increase their quality and make the fishing experience of his customers just great. The new Airblade Power SW is just the last of the many steps already taken by this company, and it is a project that leads the Airblade family straight to salt water fishing. It is an heavy duty and bigger version that is witnessing the good quality of the original project. The whole reel is made of aluminium and it is sealed with a rubber o-ring to prevent to water to enter the body. To maximize this effect, there are no screws on the body of the reel, making it even more powerful. All the Long Life bearing are stainless steel and salt water proof: they will last forever. To increase the cranking power the aluminium handle is featuring a fighting knob. Available into 2 sizes, the Airblade is going to become one of the more interesting news for 2015 for salt water predator spinning.

FEATURES

 METAL BODY	 SUPER LIGHT ALL	 7Kg MAX DRAG	 STAINLESS STEEL COMPONENTS	 AS ROLLER ANTITRUST SYSTEM
 4.9:1 GEAR RATIO	 7+1SS SHIELDED BEARINGS	 SWR SALT WATER RESISTANT	 CW CROSS WINDER POWER BAIL	 AVS ANTITRUST SYSTEM
			 ONE WAY CLUTCH	 US3 ULTRA SLIM BODY DESIGN

Code	Model	Weight	Gear Ratio	Spool Capacity	Max Drag	B.B.
033-71-500	5000	480	4.9:1 (81 cm)	Ø 0.35 mm - 245 m	7 kg	7+1
033-71-600	6000	490	4.9:1 (89 cm)	Ø 0.40 mm - 240 m	7 kg	7+1
033-71-501				Spare Spool 5000		
033-71-601				Spare Spool 6000		



The handle folds instantaneously, thanks to the one touch button.



The metal rotor has been drawn by computer to reduce weight and improve balance as well.



Body profile is ultraslim and has no external screws.

MAXXIS



MAXXIS PG

To complete the Maxxis range we've introduced the Maxxis PG 8000, featuring X-Tra Tough alloy body and designed to heavy duty specialities, such as the deep vertical jigging or the heavy spinning. All the seven Long Life SS ball bearings are sealed and give total reliability and smoothness to this high level reel, whilst the Roller Bearing run the one-way clutch, but here you'll not find the anti-reverse lever as in most of the proper saltwater reels. To protect the gears, the body is fully sealed to prevent any water come in and it's completely built with aluminium alloy as well as the rotor, the side plates and the bail arm assembly. Digital designed stainless and bronze alloy gears. The max drag power is 20Kg and again it is completely sealed from water, salt and any other debris, thanks to the o-ring positioned on the knob and through a closure disk to protect the washers. The drag works on stainless steel and carbon textile drag washers, with a fine adjustment from full release to full lock with super smooth motion all the way. The body is thin and flattened, while the rotor features a hybrid skirt made of carbon cloths, with the CNC machine cut aluminium handle fitted with an "custom" made oversized handle knob. The 4.4:1 gear ratio, is perfect for the deep vertical jigging, heavy duty spinning or popping to target the big saltwater predators. Everything is built to handle the heaviest of braided lines and control large, strong-pulling predators.

FEATURES



Enormous cranking power with no play nor vibrations, thanks to the handle directly connected to drive gear.



Main shaft is made from stainless steel to provide strength and durability.

Code	Model	Weight	Gear Ratio	Spool Capacity	Bob.Extra	B.B.
032-79-800	8000	776	4.4:1(96 cm)	18 lb - 350 m	-	7+1

MAXXIS SW GAME

Compact design, strong and reliable range of reels designed for saltwater fishing. The X-Tra Tough Body and rotor are made from a special blend of graphite, stronger and lighter than regular materials. To increase the torque resistance under maximum load, the bail arms are built by solid aluminium, so that line roller works in optimum conditions. The high performance drag system is completely sealed and based on PTFE washers to guarantee high smoothness and progression from minimum to the highest setting. All ball bearings are sealed, while gears and metal parts are Saltwater Proof, and the body has been sealed for additional protection. The aluminium Powerbail is hollow and made by one piece only, so lighter and stronger than any other on the market. The gear ratio of 4.8:1 is perfect for the light to medium jigging, kabura fishing and medium spinning, while the aluminium CNC handle is strong and lightweight and ends with a "custom" Eva Knob, ergonomic and able to guarantee optimal grip in all conditions.



The drag system is sealed to avoid water and salt intrusion.



The Powerbail include a tapered link to Anti Twist line roller, which is Titanium coated.

FEATURES



Code	Model	Weight	Gear Ratio	Spool Capacity	Bob.Extra	B.B.
032-78-550	5500	530	4.8:1 (84 cm)	14 lb - 190 m	-	7+1
032-78-650	6500	552	4.8:1 (90 cm)	14 lb - 220 m	-	7+1
032-78-800	8000	579	4.8:1 (94 cm)	17 lb - 235 m	-	7+1

SEAWOLF

4 SHIELDED
SS BALL
BEARINGS

The gold anodized dress is a traditional classic in the multiplier trolling reel's market, while the Maxel structure and engineering are the most advanced the industry can now offer to the keen anglers who look for the best only. Total reliability and strength are the two main targets which have driven the development and production of these reels, along with unique design, precision engineering and totally saltwater proof materials. Each single component has been created to get the best performance, starting from one-piece frame, machined from solid 6061-T6 tempered aluminium, well known in the aerospace and naval industry for the torque resistance property, up to consider stainless steel gearsings, aluminium spool and sealed ball bearings. SeaWolf reels are available in the range of 20-50 lbs, all featuring double speed and an extremely powerful and progressive drag, based on carbon disks to deal with the fastest runs of big sea fish.



The exclusive ergonomic 1-Bar handle is able to provide maximum cranking power with minimal effort. T-Bar actually makes the most of hand, wrist and forearm. Construction material has been chosen not to burn hands even if sun exposed during Summertime.



FEATURES

- 6061-T6 machined one piece aluminum frame
- Cold forged aluminum spool and side plates
- Precision-machined stainless steel gears
- Carbon-based contaminant-resistant drag materia
- 4 shielded stainless steel ball bearings
- Extremely tight tolerance to prevent line eating
- Heavy duty stainless steel ratcheting clicker design
- Heavy duty stainless steel drive and spool shafts
- CNC aluminum anodized reel foot
- Main shaft bearing stabilizer prevents excessive side pressure on spool bearings
- New power T-Bar handle for increased comfort and torque
- Stainless steel rod clamp and harness lugs
- Serialized identification

Code	Model	Gear Ratio	Spool Capacity	Max Strike Drag	Max Full Drag	B.B.
030-00-020	SW20	4.3:1 / 1.7:1	20 lb / 690 yds	12.2 kg	14.2 kg	4
030-00-025	SW30W	4.3:1 / 1.7:1	30 lb / 700 yds	12.4 kg	14.5 kg	4
030-00-030	SW30WL	4.3:1 / 1.7:1	50 lb / 570 yds	12.4 kg	14.5 kg	4
030-00-050	SW50W	3.6:1 / 1.3:1	50 lb / 850 yds	16.6 kg	21.6 kg	4



MACHINED RIGID FRAME. Aircraft grade aluminum construction incorporating Maxel rigid machine technology. All Maxel reels feature a strong, rigid, one-piece fully machined aluminum frame. These monolithic bar-stock frames not only keep the moving parts in precise alignment, but also maintain exacting control tolerances under heavy loading while fighting big fish.



HIGH-TECH COLD FORGED SPOOLS. Thanks to Maxel expertise and the latest cold forging technology applied during productions stages, the super strong, cold forged aluminum spool and side plates stand up to line pressure and hard fighting stresses.



ANTI CORROSION STAINLESS STEEL BEARINGS.

Maxel use top quality shielded stainless steel ball bearings assure corrosion resistance and smooth operation on line release and recovery.

MAXEL
ENGINEERED EXCELLENCE

TROLLING & JIGGING

Trabucco is the official distributor of the trolling and vertical jigging Maxel multiplier reels on the Italian market.

A reliable range of products which has been developed for those who will never accept any compromise on quality.



SEALION OB

An Hi-Tech multiplier designed for trolling and specifically with braided lines. This is the right model to fish with the downrigger and with the drift lead; in fact, it features an increased capacity spool, granting the possibility to spool enough meters of the big diameter braided required. It is evident that for other specifications we did not change the good specs that made the Sea Wolf and the Sea Lion the best multipliers to be used on a boat. So also the Sea Lion OB features a machined 6061-T6 aluminium frame. This one piece frame is the best warranty you can have about the solidity and the reliability of the reel. All the gears are made from stainless steel, the only material that can last for countless years in an aggressive and salty environment. The spool and the side covers are made of cold forged aluminium, to keep them light weight but still very strong. The lever drag and the handle have ergonomic shape and are easy to access, because when you are fighting a big fish everything must be just handy. If you summarize what a Maxel OB is giving you: light weight, ergonomic design, 100% salt water proof, stainless steel and carbon drag washers, eight double shielded stainless steel bearings and much more, you will understand why we are giving 5 years warranty. Because a Maxel reel is made for fishing and it will do it well for a long, long time.



8+2
SS SHIELDED BALL BEARING



Code	Model	Gear Ratio	Spool Capacity	Max Strike Drag	Max Full Drag	B.B.
030-01-206	06LH	4.5 : 1	310 m - 20 lb	5 kg	6 kg	8+2
030-01-209	09RH	4.5 : 1	410 m - 20 lb	8 kg	10 kg	8+2
030-01-211	11RH	4.5 : 1	545 m - 20 lb	9 kg	11 kg	8+2



CARBON DRAG SYSTEM. Maxel unique Carbon Drag system delivers wide range and smooth operation at all settings. The contaminant resistant carbon surfaces are treated with a precise amount of specially formulated MAXEL drag grease that resists water absorption and maintains powerful drag settings. Constant, steady friction and excellent heat displacement are assured through the drag surface design.



ERGO POWER KNOB. Maxel ergonomically shaped power knob provides maximum power with minimum fatigue for the game angler. The power knob takes full advantage of the natural dynamics of the human hand, wrist and forearm to help sustain power and endurance for the game angler.



SEALION

8+2
SS SHIELDED
BALL BEARING

Incorporating Maxel's precision engineering technology, designed with optimum mechanism and added features, the SeaLion series will give anglers more confidence and power during overhead jigging and live baiting. The SeaLion reels are made from 6061-T6 tempered aluminum with ported cross bars for weight reduction, and wider spool for larger line capacity. The upgraded carbon drag system is capable of outrageous drag pressures, plus the improved pre-set knob and lever drag control mechanism, allowing the SeaLion reels more precise and consistent drag setting. Also with fulcrum clicker design, it stops drag lever backing off while jigging. The SeaLion series features 2 sizes 8Lb e 10Lb available only with two speed retrieve and with right or truly left handle version to choose from.

2-SPEED GEARING. Maxel 2-Speed system consists of two sets of stainless steel main and pinion gears, allowing anglers the option of a high-speed ratio or a power ratio for maximum torque. Maxel shifting system is designed to operate in a simple and reliable way, just push the shift button and handle in for low gear, offering you the power to fight big game fish; push button and pull handle out so as to switch back to high speed ratio for quick line recovery.



PRE-SET & DRAG LEVER. Maxel pre-set knob and drag lever are designed user-friendly for precise and constant drag settings from FREE (no drag pressure), to STRIKE (where you fight the fish), until FULL (provides extra drag pressure when you need it). Turn the pre-set knob clockwise for more drag pressure, counter-clockwise for less drag pressure.



FEATURES

- 6061-T6 machined one piece aluminum frame
- Cold forged aluminum spool and side plates
- Precision-machined stainless steel gears
- Contaminant-resistant carbon drag material with special grease
- With fulcrum clicker design to stop drag lever backing off
- Oversized shielded stainless steel ball bearings for better support and strength
- Slim frame and narrow spool increased 10% more line capacity
- Newly designed balance handle to minimize the jigging vibration
- Excellent free spool
- Serialized identification

EXCELLENT FREE SPOOL

SMOOTH AND POWERFUL DRAG

CDS CARBON DRAG SYSTEM

HEAVY-DUTY AND PRECISION GEARS

ANTI-CORROSION STAINLESS STEEL BEARINGS

Ergonomically POWERFUL KNOB

Code	Model	Gear Ratio	Spool Capacity	Max Strike Drag	Max Full Drag	B.B.
030-01-008	SL08LH	4.5:1 / 2.1:1	20 lb / 330 yds	7.0 kg	8.5 kg	8+2
030-01-010	SL10LH	4.5:1 / 2.1:1	20 lb / 495 yds	8.0 kg	10.0 kg	8+2
030-01-108	SL08RH	4.5:1 / 2.1:1	20 lb / 330 yds	7.0 kg	8.5 kg	8+2
030-01-110	SL10RH	4.5:1 / 2.1:1	20 lb / 495 yds	8.0 kg	10.0 kg	8+2



MERIDIAN GT

3+1
SS SHIELDED
BALL BEARING

Meridian trolling reels are the perfect complement for Meridian Fighter Stand Up rods, and are a good and versatile option for Mediterranean trolling. Graphite body is salt water resistant and side plates are reinforced by a stainless steel ring, to strengthen the whole chassis. Handle and spool are anodized aluminium. So the reel can be spooled with braided line. The smooth drag has a Max Drag of 20 lbs and can be set up very carefully. 3+1 stainless steel shielded bearings. Fighting handle with power knob.

Code	Model	Weight	Gear Ratio	Spool Capacity	Best Drag	B.B.
030-50-300	330	470	4.1:1	Ø 0.45 mm - 320 m	20 lb	3+1

NEPTUNE SR

3 SHIELDED
SS BALL
BEARINGS

Family of easy to use, long lasting and reliable conventional reels. Two models, 15/30 and 20/40 sharing the bigger part of specs, with the exception of the Max Drag, being 20 lbs for the smaller size, and 30 lbs for the bigger one. All the gears are salt water treated and perform a 3.8:1 gear ratio, the correct compromise between speed and power. The spool, and the handle too, is made from anodized aluminium, so it can be used with braided lines. Both sizes feature level wind for an easy use and perfect line lay. Graphite body is light weight and corrosion resistant. 3 stainless steel shielded bearings.

Code	Model	Weight	Gear Ratio	Spool Capacity	Best Drag	B.B.
030-55-200	15 / 30	485	3.8:1	Ø 0.45 mm - 200 m	20 lb	3
030-55-300	20 / 40	520	3.8:1	Ø 0.45 mm - 260 m	30 lb	3



LINES & BRAIDED

First of all, the contact with bait or lure, then link to the fish. Not a mere accessory, but a vital piece of tackle, which deserves the best attentions. Line and fishing are actually inseparable.

DYNA TEX

PE braided lines with great strength per diameter, thanks to the high number of strands the profile is rounder, avoiding the line digging in the spool.



Series of monofilaments super resistant to shocks and knots, always reliable and top quality. A timeless classic of Italian fishing style.



Diamond

A true hi spec competition line. Quality and performance always consistent. It is just the best way to build super strong and totally invisible hook length.

MAXPLUS

A new range, specialized in the most common fresh and saltwater uses. Total reliability and a plus: the side cover which include the hole to hang each spool in the shop.

XPS

Hi-Tech monofilaments of the latest generation, each series is dedicated to a specific fishing techniques and it is essential due to its unique structure



Super soft and abrasion resistant monofilaments, the best for spooling your reels. Specific lines available for Match, Surf Casting, Predator, Feeder and, generally, for all the techniques that need long casting performance.

SUPER ELITE

The highest quality monofilament in the world. You will never find on the market any other monofilament with such a high strength test.

XP-Line

Reliable monofilaments family with specific polymers for each fishing technique. The parallel winding grants a great care of the product and an always consistent quality.

TPS TRABUCCO PARALLEL SPOOLING



Just after extrusion process, which converts the raw material into the final product commonly known as fishing line, the monofilament must already face some enemies, which tend to affect its integrity and degrade its quality. Ultra-violet rays get it older, decreasing its linear strength; the humidity is a critical factor, as it

shouldn't be too low, nor too high, because it has some influence on flexibility of the product and on its stretch properties. All elements which count a lot in term of specification's stability during the line's life, important details to whom Trabucco production pays a lot of care and attention. But there is a factor that, more than the others, can actually cast a dark shadow on to line's performances, and such point is the spooling process. When the monofilament gets from the big spools to commercial, small ones, the machines involved in the operation can induce abnormal tension and torque, up to "loading" the line with a stress that will be given us back when we will wind it on to the reel's spool or when we will use it to build up a rig or an hooklink. The solution used by Trabucco to overcome this problem on high end lines is the parallel spooling, a special process which cannot be applied on the whole range due to longer time process that, in the end, causes cost's increase. A very special machine lays every coil parallel to the previous one under high precision and minimal tension, without inducing any torsion and generating the fantastic effect which everybody can see through a magnifying glass. Excess of accuracy? Maniacal care? Nothing wrong, because only in this way the line will come off the spool with unchanged specifications, the best precondition to get the optimum from it, with less tendency to tangle and with a smooth flow through rod's guides.

SYMBOLS Diameter Breaking Strength Kg Breaking Strength Lb



Gábor Nagy

SPIN

DYNA TEX

Dyna-Tex is a super abrasion resistant braided multifibre line that can be used for spinning, vertical jigging, long range casting or for fishing with every other technique. It is practically non-elastic and incredibly soft to allow long casting. Dyna-Tex colour is moss green with a twist of yarns resistant to abrasion and twisting. When used as a shock leader it can be connected to the main line with a Mahin knot. For attaching a swivel we recommend the use of the Palomar knot and Eyed hooks can be fitted with the "knotless knot". The 80lbs version is targeted at big catfish fishing.



Code	Ø	⚖	🐟	
054-40-120/10	0.12	8.16	18.00	150m
054-40-140/10	0.14	9.07	20.00	
054-40-160/10	0.16	9.98	22.00	
054-40-180/10	0.18	11.34	25.00	
054-40-200/10	0.20	13.61	30.00	
054-40-240/10	0.24	18.14	40.00	300m
054-41-160/5	0.16	9.98	22.00	
054-41-180/5	0.18	11.34	25.00	
054-41-200/5	0.20	13.61	30.00	
054-41-240/5	0.24	18.14	40.00	
054-41-450/5	0.45	36.29	80.00	

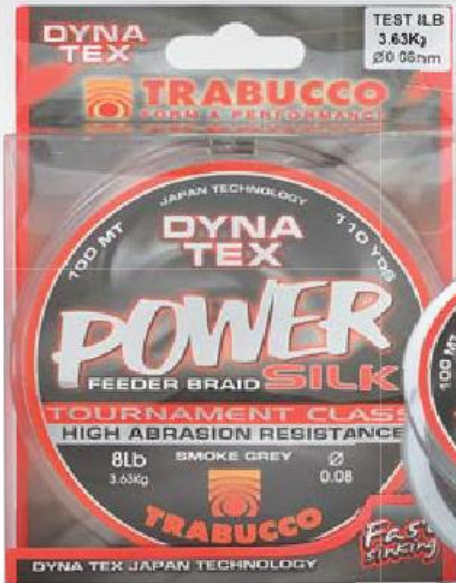

NEW POWER SILK FEEDER BRAID **DYNA TEX**

Specially developed for feeder fishing, this braided line is a combination of super strong Dyna Tex fibers and other heavier ones, which make this line sink perfectly and lay on the bottom. Such behaviour is well appreciated in feeder fishing, as it drops those line bows for ever. Therefore, the strike is neat, powerful and hook setting is very accurate: up to yesterday, just a nice dream. The available diameters allow to face all possible fishing conditions with a very high abrasion resistance and a round cross section. A shock leader twice long as the rod itself is highly recommended, maybe made from XPS Match Reel.

Code	∅	⚖	🐟	100m
054-39-008/10	0.08	3.60	8.00	
054-39-010/10	0.10	4.50	10.00	
054-39-013/10	0.13	5.40	12.00	

POWER SILK

DYNA TEX

Brand new Dyna-Tex braided line, very tightened weaving to achieve a rounder profile. External surface has been treated to achieve a silk like finishing, very comfortable and enjoyable during fishing sessions, when the braided passes through the guides of the rod with minimized friction. Breaking strength printed on label are reported to plain knot. More technical fishing knots will easily achieve higher breaking strength. Spool delivered in thick plastic box for better storage.

Code	∅	⚖	🐟	100m
054-37-080/10	0.08	3.63	8.00	
054-37-100/10	0.10	4.54	10.00	
054-37-120/10	0.12	5.45	12.00	
054-37-140/10	0.14	6.81	15.00	
054-37-160/10	0.16	9.08	20.00	
054-37-200/10	0.20	13.62	30.00	



FUSION BRAID

DYNA TEX

Made using the latest Japanese technology, Dyna-Tex Fusion Braid is produced with high tension procedure which allows to obtain more compact fibers that can be better spooled on the reel, drastically reducing the possibility of tangles. The special coating provides exceptional abrasion resistance and a much smoother surface than the classical braided lines. This protects the guides, ensuring durability of the line and extreme casting performance. The total absence of elasticity allows you to immediately set the hooks even when fishing at extreme distance. Available in smoke grey from diameter 0,10 to 0,30 in a classy spool of 100m.



Code	∅	⚖	🐟	100m
054-43-100/10	0.10	5.44	12	
054-43-120/10	0.12	6.80	15	
054-43-150/10	0.15	8.16	18	
054-43-180/10	0.18	9.07	20	
054-43-200/10	0.20	11.34	25	
054-43-250/10	0.25	13.61	30	
054-43-300/10	0.30	18.14	40	
054-35-100/5	0.10	3.65	8	275m
054-35-120/5	0.12	6.86	15	

FLUORO CARBON

Code	∅	△	∞
053-60-060/10	0.065	0.55	1.21
053-60-070/10	0.074	0.63	1.38
053-60-080/10	0.084	0.99	2.18
053-60-090/10	0.098	1.34	2.95
053-60-100/10	0.104	1.45	3.19
053-60-120/10	0.125	1.60	3.52
053-60-140/10	0.145	2.10	4.63
053-60-160/10	0.164	2.58	5.67
053-60-180/10	0.185	3.21	7.08
053-60-200/10	0.201	3.85	8.48
053-60-220/10	0.220	4.41	9.72
053-60-240/10	0.240	5.31	11.70
053-60-260/10	0.260	6.44	14.18
053-60-280/10	0.280	7.16	15.78
053-60-300/10	0.300	7.72	17.02

50m

053-59-080/10	0.084	0.99	2.18
053-59-090/10	0.098	1.34	2.95
053-59-100/10	0.104	1.45	3.19
053-59-120/10	0.125	1.60	3.52
053-59-140/10	0.145	2.10	4.63
053-59-159/10	0.164	2.58	5.67
053-59-180/10	0.185	3.21	7.08
053-59-200/10	0.201	3.85	8.48
053-59-220/10	0.220	4.41	9.72
053-59-240/10	0.240	5.31	11.70
053-59-259/10	0.260	6.44	14.18
053-59-280/10	0.280	7.16	15.78
053-59-300/10	0.300	7.72	17.02

25m

NEW



Made from 100% fluorocarbon, this line is particularly soft, abrasion resistant and well sinking. Its main characteristic is the very low light refraction index, which makes it almost invisible in water. Remarkably waterproof, it keeps the original breaking strength - already higher than the average - even after a long time of stay in water. Perfect for hooklinks destined either to fresh or salt water, it is totally UV resistant for a longer life. From now, beyond the traditional 50 m spools, it is also available in 25 m version.

MATCH STRONG



Electronically controlled to ensure accurate and consistent diameter, this match line features unrivalled knot strength and softness. The clear, dichroic colour makes it perfect to build hooklinks and rigs for freshwater as well as saltwater. The advanced spooling process, based on perfectly parallel winding, enables to avoid those dangerous torsions which affect strength and casting distances, making the line virtually tangle free. Today, the successful XPS Match Strong family grows with the addition of new 25 metres spools, surely destined to succeed in the hooklink field, also in feeder fishing segment.

Code	∅	△	∞
053-82-080/10	0.084	1.00	2.20
053-82-090/10	0.091	1.18	2.60
053-82-100/10	0.104	1.60	3.52
053-82-120/10	0.121	2.30	5.07
053-82-140/10	0.143	2.95	6.50
053-82-160/10	0.162	3.98	8.77
053-82-180/10	0.181	5.10	11.23
053-82-200/10	0.203	5.95	13.11

25m

NEW



Code	∅	△	∞
053-80-060/10	0.064	0.66	1.45
053-80-070/10	0.072	0.74	1.63
053-80-080/10	0.084	1.00	2.20
053-80-090/10	0.091	1.18	2.60
053-80-100/10	0.104	1.60	3.52
053-80-120/10	0.121	2.30	5.07
053-80-140/10	0.143	2.95	6.50
053-80-160/10	0.162	3.98	8.77
053-80-180/10	0.181	5.10	11.23
053-80-200/10	0.203	5.95	13.11
053-80-220/10	0.221	6.83	15.04
053-81-250/10	0.251	8.67	19.10
053-81-280/10	0.283	9.98	21.98
053-81-300/10	0.307	12.72	28.02

50m

Code	∅	△	∞
053-78-080/10	0.084	1.00	2.20
053-78-090/10	0.091	1.18	2.60
053-78-100/10	0.104	1.60	3.52
053-78-120/10	0.121	2.30	5.07
053-78-140/10	0.143	2.95	6.50
053-78-160/10	0.162	3.98	8.77
053-78-180/10	0.181	5.10	11.23
053-78-200/10	0.203	5.95	13.11
053-78-220/10	0.221	6.83	15.04
053-78-250/10	0.251	8.67	19.10
053-78-300/10	0.307	12.72	28.02
053-78-350/10	0.350	15.90	35.00
053-78-400/10	0.400	18.17	40.00
053-78-500/10	0.500	22.72	50.00
053-78-600/10	0.600	36.34	80.00

100m

TPS

POWER PLUS



Last generation monofilament to create low visibility, high strength hook links. Polymeric chains that form the core of the line are longer and more powerful, giving as a final result a tougher and softer line, for a perfect presentation of bait. XPS Power Plus has a nice packaging with a PVC trade box containing another thick plastic box with line retainer to better preserve quality line from light and dirt.

Code	Ø	⚖	🐟
053-83-080/10	0.084	1.07	2.36
053-83-090/10	0.094	1.26	2.78
053-83-100/10	0.104	1.71	3.77
053-83-120/10	0.121	2.46	5.42
053-83-140/10	0.143	3.16	6.95
053-83-160/10	0.162	4.26	9.38
053-83-180/10	0.183	5.46	12.02
053-83-200/10	0.203	6.37	14.02
053-83-220/10	0.221	7.31	16.10
053-83-250/10	0.251	9.28	20.43
053-83-280/10	0.283	10.68	23.52
053-83-300/10	0.307	13.61	29.98

50m

LUCIFER LINE

The Lucifer is a brand very famous within the angling fans of England by many years. Under this brand name we have produced a wide range of specific product for the commercial fisheries and carps in general. Ideal for making rigs and even used as mainline. It is a pretty rigid monofilament, with total absence of memory and sealed by water absorption by the innovative ceramic coating process, new for this season. Crystal clear color.

Code	Ø	⚖	🐟
053-30-100/10	0.100	1.50	3.30
053-30-120/10	0.120	2.15	4.74
053-30-140/10	0.140	2.85	6.28
053-30-160/10	0.160	3.80	8.37
053-30-180/10	0.180	4.65	10.42
053-30-200/10	0.200	5.60	12.34

TPS

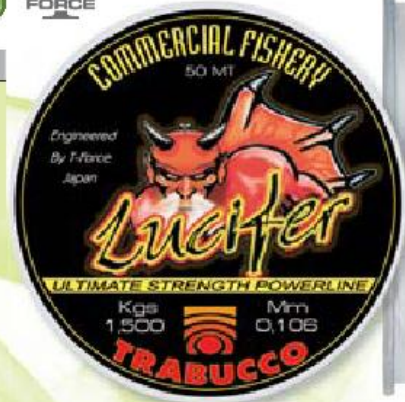

50m



Code	Ø	⚖	🐟
053-25-060/10	0.06	0.60	1.32
053-25-080/10	0.08	0.92	2.03
053-25-100/10	0.10	1.50	3.30
053-25-120/10	0.12	2.15	4.74
053-25-140/10	0.14	2.85	6.28
053-25-160/10	0.16	3.80	8.37
053-25-180/10	0.18	4.65	10.24
053-25-200/10	0.20	5.60	12.34
053-25-220/10	0.22	6.46	14.23
053-25-250/10	0.25	8.46	18.61
053-25-280/10	0.28	9.65	21.26
053-25-300/10	0.30	12.07	26.55
053-25-350/10	0.35	14.40	31.72
053-25-400/10	0.40	18.90	41.63
053-25-500/10	0.50	27.00	59.47

100m

MATCH PRO



Crystal clear colored, claimed as one of the best long pole and fishing to hand monofilament ever produced. The new ceramic technology launched by the T-Force laboratories has immediately encountered the approval of all anglers worldwide, as it gives an incredible knot resistance and linear strength. It is recommended as mainline for long pole and line to hand fishing, as well as for the rig making. The ceramic coating also seal completely the nylon core making it 100% waterproof without increasing the diameter, like happen usually with the normal silicone coatings. Another evidence of the superior technology of the T-Force laboratories, that have been always years ahead of the competitors.

Code	Ø	⚖	🐟
053-26-100/10	0.10	1.50	3.30
053-26-120/10	0.12	2.15	4.74
053-26-140/10	0.14	2.85	6.28
053-26-160/10	0.16	3.80	8.37
053-26-180/10	0.18	4.65	10.24
053-26-200/10	0.20	5.60	12.34
053-26-250/10	0.25	8.46	18.61
053-26-300/10	0.30	12.07	26.55

300m

SOFT FEEL

TPS XPS T-FORCE



The latest generation of high resistance monofilaments issued by the T-Force technology the World's leading producer of hi-tech fishing monofilaments. With its strength exceeding even extreme limits this line also features a total memory absence. XPS Soft Feel is a ultra-supple monofilament specifically developed for all styles of reel fishing. It's a floating line so it's particularly suited to Bolognese both for fresh and saltwater uses. Its smoothness helps the flowing from the reel spool during casts, without any kind of torsion and increasing casting distances. The ceramic coating of the nylon polymer core, makes this line completely waterproof and totally memory-free.

Code	∅	△	⊘	
053-88-120/10	0.128	2.20	4.85	150m
053-88-140/10	0.148	2.92	6.43	
053-88-160/10	0.165	3.89	8.57	
053-88-180/10	0.181	4.76	10.48	
053-88-200/10	0.203	5.74	12.64	
053-88-220/10	0.234	6.82	14.58	
053-88-250/10	0.251	8.67	19.10	
053-88-280/10	0.283	9.89	21.78	
053-88-300/10	0.307	12.37	27.25	

MATCH REEL

TPS XPS T-FORCE

Smoke grey colored new monofilament, of last generation, developed for all kind of reel fishing styles. The particular technical qualities of these new nylon resins and polymers, allow to a better flow into the guides, superior to any other high quality reel line in the market. It also helps the flowing out from the reel spool, without any kind of torsion. The ceramic coating of the nylon polymer core, makes this line completely waterproof and cancel any kind of memory. Despite its strength, the new Match Reel is supple and soft. It is spooled in parallel, in 150mt spools packed into a new Japan style box, very classy. It is truly one of the best specific reel line, that combine the greatest flowing and abrasion capacity together the legendary and even improved resistance of all T-Force monofilaments.

Code	∅	△	⊘	
053-28-120/10	0.128	2.15	4.74	150m
053-28-140/10	0.148	2.85	6.28	
053-28-160/10	0.165	3.80	8.37	
053-28-180/10	0.181	4.65	10.24	
053-28-200/10	0.203	5.60	12.34	
053-28-250/10	0.255	8.46	18.63	
053-28-300/10	0.309	12.07	26.57	



WINTER ICE

XPS T-FORCE



The soft ring provided with each spool enables to pick up any needed quantity of line, avoiding damages to the rest of the product.

Code	∅	△	⊘	
053-33-080/10	0.08	1.00	2.20	25m
053-33-100/10	0.10	1.60	3.52	
053-33-120/10	0.12	2.30	5.07	
053-33-140/10	0.14	2.95	6.50	
053-33-160/10	0.16	3.98	8.77	
053-33-180/10	0.18	5.10	11.23	
053-33-200/10	0.20	5.95	13.11	
053-33-250/10	0.25	8.67	19.10	50m
053-33-300/10	0.30	12.72	28.02	
053-32-080/10	0.08	1.00	2.20	
053-32-100/10	0.10	1.60	3.52	
053-32-120/10	0.12	2.30	5.07	
053-32-140/10	0.14	2.95	6.50	
053-32-160/10	0.16	3.98	8.77	
053-32-180/10	0.18	5.10	11.23	
053-32-200/10	0.20	5.95	13.11	
053-32-250/10	0.25	8.67	19.10	
053-32-300/10	0.30	12.72	28.02	

New line made through a very special production process, which integrate nano-particles of ceramic into a polymer matrix. Those particles, well known in the industry for their properties to resist any sharp step in temperature, protect the line's core in ice-cold conditions, which are the worst enemy of line's softness and breaking strength. The exter-

nal fluorocarbon layer adds protection from abrasion, UV rays and aggressive agents. The final result is an extremely high performance line, destined to draw the attention of the northern European anglers who fish on ice, as well as the continental ones who like trout fishing, and who will appreciate its resistance to cut. Each spool is supplied with a soft,

elastic ring which enables to pick up the needed segment of line; a typical sign of attention to user's needs, which marks the Trabucco production since ever.

MATCH SINKING

Japanese production monofilament made especially for waggler or feeder fishing. The main feature of this innovative monofilament is its high specific weight which allows it to sink extremely easily. Special surface treatment ensures high abrasion resistance and total absence of memory, both fundamental for this type of fishing where the line is subject to great stress. The special molecular composition ensures low elasticity for rapid, sure strikes. Parallel wound to better preserve its incredible characteristics. 150 & 300m spools.

TPS

Code	∅	⚖	🐟
053-85-120/10	0.128	2.05	4.52
053-85-140/10	0.148	2.70	5.95
053-85-160/10	0.165	3.60	7.93
053-85-180/10	0.181	4.43	9.76
053-85-200/10	0.203	5.30	11.67
053-85-250/10	0.255	7.95	17.51
053-85-300/10	0.309	9.78	21.54

150m

Code	∅	⚖	🐟
053-86-120/10	0.128	2.05	4.52
053-86-140/10	0.148	2.70	5.95
053-86-160/10	0.165	3.60	7.93
053-86-180/10	0.181	4.43	9.76
053-86-200/10	0.203	5.30	11.67
053-86-250/10	0.255	7.95	17.51
053-86-300/10	0.309	9.78	21.54

300m



FEEDER PLUS

TPS

XPS FORCE

Feeder fishing is becoming more and more popular, that's why we introduce an upgraded monofilament specifically designed. We paid a lot of attention to abrasion resistance and sinking ratio, two of the most important features for a feeder line, obtaining what's probably the best line actually on the market. Stretching is significantly reduced to detect even the most delicate bites at long distance. In a camouflage color to match the lakedbed.

Code	∅	⚖	🐟
053-95-180/10	0.181	3.61	8
053-95-200/10	0.203	4.51	10
053-95-220/10	0.221	5.68	13
053-95-250/10	0.251	7.03	15
053-95-300/10	0.307	9.86	22

150m

TROUT

TPS

XPS FORCE

This new transparent monofilament is dedicated to all the people who loves fishing for trout in lakes or in natural waters. Its color makes it perfect for use especially in crystal clear water. The special manufacturing procedure used makes it extremely resistant to twisting and the extremely smooth surface allows to reach incredible casting distance even using light-weight lures or rigs. Available in five different diameters on 150 meters spool.

Code	∅	⚖	🐟
053-93-160/10	0.165	2.73	6
053-93-180/10	0.181	3.61	8
053-93-200/10	0.203	4.51	10
053-93-220/10	0.221	5.68	13
053-93-250/10	0.250	7.03	15

150m



BLACK BASS



This new dark green colour monofilament has been developed for Black Bass fishing, highly demanded by the US market and also from Europe during the last years. It is the strongest polymer ever produced by the T-Force laboratories, with a very low stretch capacity, softer than any other specific spinning line, and it offers the right technical features that allow the angler to more accurate and longer casts. The absence of elasticity gives the "direct bait control" allowing to have the faster strike capacity you have ever experienced.

Code	∅	⚖	🐟	150m
053-05-200/10	0.200	5.45	12.00	
053-05-220/10	0.220	6.95	15.31	
053-05-250/10	0.250	8.36	18.41	
053-05-300/10	0.300	11.95	26.32	
053-05-350/10	0.350	15.80	34.80	

SPINNING PIKE



Another specific spinning monofilament. We have used the qualities of the Black Bass but in this version we have increased the abrasion resistance, in order to offer the greatest resistance to the jaws of those big Pikes. The absence of elasticity allow the immediate strike, and also helps the reel drag during the fight. dark green colored, offered in spools of 150mts, parallel spooled and individually packed from diameter 0,16 up to 0,35mm.

Code	∅	⚖	🐟	150m
053-55-160/10	0.160	3.65	8.04	
053-55-180/10	0.180	4.50	9.91	
053-55-200/10	0.200	5.45	12.00	
053-55-220/10	0.220	6.95	15.31	
053-55-250/10	0.250	8.36	18.41	
053-55-300/10	0.300	11.95	26.32	
053-55-350/10	0.350	15.80	34.80	



CARP ENDURO



A carp fishing Japanese production monofilament. Principal characteristic of this monofilament is the high specific weight that allows to sinking with extreme facility. The surface treatment guarantees besides, a high resistance to the abrasion and a complete absence of memory, fundamental in these types of fishing in which the mainline is submitted to strong stresses. The molecular composition guarantees a low degree of elasticity, that allows a strong rapids and sure hook setting. Spools comes in parallel winding to preserve to the best his unbelievable characteristics.



Code	∅	⚖	🐟	300m
053-11-250/6	0.255	8.36	18.41	
053-11-280/6	0.286	9.80	21.59	
053-11-300/6	0.309	11.95	26.32	
053-11-320/6	0.325	13.85	30.51	
053-11-350/6	0.354	15.80	34.80	
053-11-400/6	0.405	21.15	46.59	

Code	∅	⚖	🐟	600m
053-12-250/6	0.255	8.36	18.41	
053-12-280/6	0.286	9.80	21.59	
053-12-300/6	0.309	11.95	26.32	
053-12-320/6	0.325	13.85	30.51	
053-12-350/6	0.354	15.80	34.80	
053-12-400/6	0.405	21.15	46.59	

Code	∅	⚖	🐟	1200m
053-13-250/1	0.255	8.36	18.41	
053-13-280/1	0.286	9.80	21.59	
053-13-300/1	0.309	11.95	26.32	
053-13-320/1	0.325	13.85	30.51	
053-13-350/1	0.354	15.80	34.80	
053-13-400/1	0.405	21.15	46.59	

TROUTER



The innovative line structure combined with the external silicone coating, reduces the mechanical memory of the line maintaining a great softness, ideal for a correct bait presentation. Completely impermeable, the particular coating isolates the inner line structure from external agents, preserving the line characteristics for a long time and also in the lowest temperatures. The frictions are reduced to the minimum allowing long castings and reducing to the least one the abrasion against the guides. The transparent colour maintains low refraction degree in all kinds of waters.

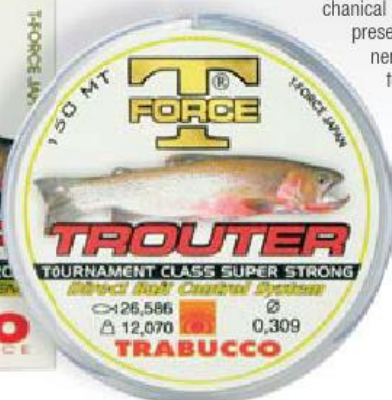

Code	∅	⚖	🐟	150m
053-52-140/10	0.140	2.85	6.28	
053-52-160/10	0.160	3.80	8.37	
053-52-180/10	0.180	4.65	10.24	
053-52-200/10	0.205	5.60	12.36	
053-52-220/10	0.227	7.05	15.53	
053-52-250/10	0.255	8.46	18.63	
053-52-300/10	0.309	12.07	26.59	

SPINNING PERCH



Monofilament expressly developed for Perch fishing both with live or dead baits or spinning. It comes in a microic light grey color, invisible under water. It features an excellent abrasion resistance and a controlled stretch this to allow more accurate and longer casts. The absence of elasticity gives the "direct bait control" allowing to have the faster strike capacity you have ever experienced and a bait control. To achieve this results T-Force has developed specific polymers, added an higher tensile and knot strenght. It comes in 150mt spools parallel spooled and individually packed.

Code	∅	⚖	🐟	150m
053-50-140/10	0.140	2.85	6.28	
053-50-160/10	0.160	3.80	8.37	
053-50-180/10	0.180	4.65	10.24	
053-50-200/10	0.200	5.60	12.36	
053-50-220/10	0.220	7.05	15.53	
053-50-250/10	0.250	8.46	18.63	
053-50-300/10	0.300	12.07	26.59	



PRO CARP

This monofilament, created by top Anglo-Saxon experts especially for Carp Fishing, is highly abrasion-resistant with great knot strength and a complete absence of memory, combined with low elasticity for rapid hook setting even over long distances. During casting its softness reduces friction with the guides to a minimum, allowing longer, more precise casts. The brown colour gives perfect camouflage. Parallel wound in 300 to 1.000m spools.



Goran Radovic



Code	∅	⚖	🐟	300m
053-15-250/5	0.250	8.36	18.41	
053-15-280/5	0.280	9.80	21.59	
053-15-300/5	0.300	11.95	26.32	
053-15-320/5	0.320	13.85	30.51	
053-15-350/5	0.350	15.80	34.80	
053-15-400/5	0.400	21.15	46.59	

Code	∅	⚖	🐟	1000m
053-17-250/5	0.250	8.36	18.41	
053-17-280/5	0.280	9.80	21.59	
053-17-300/5	0.300	11.95	26.32	
053-17-320/5	0.320	13.85	30.51	
053-17-350/5	0.350	15.80	34.80	

TOURNAMENT TOUGH

Spooled with the system "parallel" that eliminates completely the line torsion during the production process. This version Tournament Tough is particularly soft and with an extraordinary traction strength. It is recommended for fishing with telescopic whips but also for reel fishing for long casts. The color is clear microic. Delivered in single box with spools of 150, 300 and 500 mts, with diameters from 0,106 up to 0,50 mm.

TPS

Code	∅	⚖	🐟
052-30-100/10	0.106	1.45	3.20
052-30-120/10	0.128	2.10	4.63
052-30-140/10	0.148	2.80	6.18
052-30-160/10	0.165	3.75	8.27
052-30-180/10	0.185	4.60	10.14
052-30-200/10	0.205	5.50	12.13
052-30-220/10	0.220	6.95	15.32
052-30-250/10	0.255	8.40	18.52
052-30-280/10	0.280	9.54	21.03
052-30-300/10	0.300	12.00	26.45
052-30-350/10	0.350	15.85	34.94
052-30-400/10	0.400	20.20	44.53
052-30-450/10	0.450	27.50	60.62
052-30-500/10	0.500	35.00	77.15

150m



052-35-100/5	0.106	1.45	3.20
052-35-120/5	0.128	2.10	4.63
052-35-140/5	0.148	2.80	6.18
052-35-160/5	0.165	3.75	8.27
052-35-180/5	0.185	4.60	10.14
052-35-200/5	0.205	5.50	12.13
052-35-250/5	0.255	8.40	18.52
052-35-300/5	0.300	12.00	26.45

300m



052-37-100/5	0.106	1.45	3.20
052-37-120/5	0.128	2.10	4.63
052-37-140/5	0.148	2.80	6.18
052-37-160/5	0.165	3.75	8.27
052-37-180/5	0.185	4.60	10.14
052-37-200/5	0.205	5.50	12.13
052-37-250/5	0.255	8.40	18.52
052-37-300/5	0.300	12.00	26.45
052-37-350/5	0.350	15.85	34.94
052-37-400/5	0.400	20.20	44.53
052-37-450/5	0.450	27.50	60.62
052-37-500/5	0.500	35.00	77.15

500m

SUPER CAST

This monofilament has been developed for the reel fishing, such as spinning, for its great flowing capacity. It allows to long distance casts and it features a superior abrasion resistance than many other monofilament in the market place. The pale green color assures a perfect mimetism into the water. It is available in spools of 150, 300 and 500 mts in single spool box.

TPS

Code	∅	⚖	🐟
052-40-120/10	0.128	2.05	4.52
052-40-140/10	0.148	2.76	6.09
052-40-160/10	0.165	3.71	8.18
052-40-180/10	0.185	4.57	10.08
052-40-200/10	0.205	5.42	11.95
052-40-250/10	0.255	8.35	18.41
052-40-300/10	0.300	11.92	26.28
052-40-350/10	0.350	15.79	34.81
052-40-400/10	0.400	20.13	44.37
052-40-450/10	0.450	27.50	60.62
052-40-500/10	0.500	35.00	77.15

150m



052-45-140/5	0.148	2.76	6.09
052-45-160/5	0.165	3.71	8.18
052-45-180/5	0.185	4.57	10.08
052-45-200/5	0.205	5.42	11.95
052-45-250/5	0.255	8.35	18.41
052-45-300/5	0.300	11.92	26.28

300m



052-47-140/5	0.148	2.76	6.09
052-47-160/5	0.165	3.71	8.18
052-47-180/5	0.185	4.57	10.08
052-47-200/5	0.205	5.42	11.95
052-47-250/5	0.255	8.35	18.41
052-47-300/5	0.300	11.92	26.28

500m

SUPER SOFT

The softest version on T-Force collection with its best use with reels. Its softness allows extra long cast and better bait presentation. Very good also for sea fishing from harbour banks. The warm golden color makes the line visible to angler but is completely invisible down the water.

TPS



Code	∅	⚖	🐟
052-55-140/10	0.148	2.76	6.09
052-55-160/10	0.165	3.71	8.18
052-55-180/10	0.185	4.57	10.08
052-55-200/10	0.205	5.42	11.95
052-55-250/10	0.255	8.35	18.41
052-55-300/10	0.300	11.92	26.28
052-55-350/10	0.350	15.79	34.81
052-55-400/10	0.400	20.13	44.37

200m

052-57-140/5	0.148	2.76	6.09
052-57-160/5	0.165	3.71	8.18
052-57-180/5	0.185	4.57	10.08
052-57-200/5	0.205	5.42	11.95
052-57-250/5	0.255	8.35	18.41
052-57-300/5	0.300	11.92	26.28
052-57-350/5	0.350	15.79	34.81
052-57-400/5	0.400	20.13	44.37

500m



SUPER HARD



Super rigid line, developed for fishing at long distances, in which is indispensable a direct and immediate contact with the bait. Highly recommended for feeder fishing, carp fishing and spinning. Very high abrasion resistance, a common quality of all T-Force lines, and exceptional knot strength. The color is dark brown and it is parallel spooled.

Code	∅	⚖	🐟
052-60-250/5	0.255	8.48	18.69
052-60-300/5	0.300	12.15	26.78
052-60-350/5	0.350	15.95	35.16
052-60-400/5	0.400	20.30	44.75

300m

SPECIAL FEEDER



Specific monofilament for feeder fishing. The colour is dark brown and it is a very rigid line, with a controlled stretch and a high abrasion resistance. It allows the angler to distant and very accurate casts. It can be also used in all kind of bottom fishing as well as for waggler fishing.

Code	∅	⚖	🐟
052-63-120/10	0.120	2.10	4.63
052-63-140/10	0.140	2.80	6.18
052-63-160/10	0.160	3.75	8.27
052-63-180/10	0.180	4.60	10.14
052-63-200/10	0.200	5.50	12.13
052-63-220/10	0.220	6.95	15.32
052-63-250/10	0.250	8.40	18.52
052-63-300/10	0.300	11.92	26.28

150m



COMPETITION PRO



Clear dicroic monofilament, available in spoos of 25 and 50 mts. Absolutely invisible in water, it has a great smoothness and very high knot strength. It is spooled with the new japanese style "parallel" that eliminates completely the torsion of the line during the production process, and allows the monofilament to a better flowing during the fishing action. It is ideal for making rigs and hook length, and because the special silicon treatment also for sea fishing. The package is made of an heavy shell that preserves the qualities of the line by the external agents.



Code	∅	⚖	🐟
052-65-080/10	0.080	0.86	1.90
052-65-100/10	0.100	1.45	3.20
052-65-120/10	0.120	2.10	4.63
052-65-140/10	0.140	2.80	6.18
052-65-160/10	0.160	3.75	8.27
052-65-180/10	0.180	4.60	10.14
052-65-200/10	0.200	5.50	12.13
052-65-220/10	0.220	6.95	15.32
052-65-250/10	0.250	8.40	18.52
052-65-300/10	0.300	12.00	26.45

25m

Code	∅	⚖	🐟
052-70-080/10	0.080	0.86	1.90
052-70-100/10	0.100	1.45	3.20
052-70-120/10	0.120	2.10	4.63
052-70-140/10	0.140	2.80	6.18
052-70-160/10	0.160	3.75	8.27
052-70-180/10	0.180	4.60	10.14
052-70-200/10	0.200	5.50	12.13
052-70-220/10	0.220	6.95	15.32
052-70-250/10	0.250	8.40	18.52
052-70-300/10	0.300	12.00	26.45

50m

WINTER ICE



Specific monofilament for the ice fishing or winter fishing in very cold waters. This special polymer has been developed to maintain its qualities of suppleness and resistance with temperatures up to -40 degrees. Coated by

Code	∅	⚖	🐟
053-36-080/10	0.080	0.86	1.90
053-36-100/10	0.100	1.45	3.20
053-36-120/10	0.120	2.10	4.63
053-36-140/10	0.140	2.80	6.18
053-36-160/10	0.160	3.75	8.27
053-36-180/10	0.180	4.60	10.14
053-36-200/10	0.200	5.50	12.13
053-36-250/10	0.250	8.40	18.52
053-36-300/10	0.300	12.00	26.45

25m

the new revolutionary ceramic process that seal the nylon avoiding the water a absorption and also maintaining the suppleness that is heavily harmed by the low temperature. Packed in spoos of 25 & 50mts, with an heavy plastic shell that protects the line when stored. Crystal clear colour. Highly recommended also for commercial fisheries in winter.

Code	∅	⚖	🐟
053-35-080/10	0.084	0.86	1.90
053-35-100/10	0.104	1.45	3.20
053-35-120/10	0.128	2.10	4.63
053-35-140/10	0.148	2.80	6.18
053-35-160/10	0.165	3.75	8.27
053-35-180/10	0.181	4.60	10.14

50m

SUPER ISO

XPS FORCE

This version of T-Force has been developed for sea fishing. Extraordinary strength and resistant to abrasion and corrosion due to the salt. Its knot strength had become a legend into the fishing world, and is superior to any other monofilament in the market place. The dark blue color makes it invisible in fishing.

Code	Ø	Δ	∞	
052-50-200/10	0.205	5.45	12.02	150m
052-50-220/10	0.220	6.95	15.32	
052-50-250/10	0.255	8.36	18.43	
052-50-300/10	0.300	11.94	26.32	
052-50-350/10	0.350	15.80	34.83	
052-50-400/10	0.400	20.15	44.42	
052-50-450/10	0.450	27.50	60.62	300m
052-50-500/10	0.500	34.96	77.06	
052-51-200/5	0.205	5.45	12.02	
052-51-250/5	0.255	8.36	18.43	
052-51-300/5	0.300	11.94	26.32	
052-51-350/5	0.350	15.80	34.83	
052-51-400/5	0.400	20.15	44.42	
052-51-450/5	0.450	27.50	60.62	
052-51-500/5	0.500	34.96	77.06	
052-52-060/2	0.600	35.50	78.25	
052-52-070/2	0.700	38.20	84.20	
052-52-080/2	0.800	41.70	91.91	
052-52-090/2	0.900	48.10	105.95	
052-52-100/2	1.000	61.50	135.55	
052-53-200/5	0.205	5.45	12.02	500m
052-53-220/5	0.220	6.95	15.32	
052-53-250/5	0.255	8.36	18.43	
052-53-280/5	0.280	9.54	21.03	
052-53-300/5	0.300	11.94	26.32	
052-53-350/5	0.350	15.80	34.83	
052-53-400/5	0.400	20.15	44.42	
052-53-450/5	0.450	27.50	60.62	
052-53-500/5	0.500	34.96	77.06	

TPS



DEEP ISO

FORCE

This new Monofilament is specifically developed for boat fishing. It is highly visible and soft with a total lack of memory. The special red color is highly visible on the surface for better control of line, while at 10m of depth makes it absolutely invisible to the fish. Deep Iso is particularly resistant to traction and torsion, and can therefore be safely used for trolling. The silicone-based coating makes it waterproof and airtight to combat saltwater marine agents.

Code	Ø	Δ	∞	
052-48-300/6	0.309	11.95	26.32	300m
052-48-350/6	0.354	15.80	34.80	
052-48-400/6	0.405	20.30	44.71	
052-48-450/6	0.450	27.50	60.57	
052-48-500/6	0.500	34.96	77.0	600m
052-49-300/6	0.309	11.95	26.32	
052-49-350/6	0.354	15.80	34.80	
052-49-400/6	0.405	20.30	44.71	
052-49-450/6	0.450	27.50	60.57	
052-49-500/6	0.500	34.96	77.00	

TPS



SPECIAL SEA

FORCE

T-Force mono created and developed with trolling and game fishing in mind. The color is crystal clear, and it has an unbelievable resistance to the abrasion and sea corrosion. This line has virtually no memory, an ideal quality for a trolling line. During the production process it is coated with a special resin treatment in order to seal the polymers and protect the line from salty agents. Supplied with 300mts spools in individual box.

Code	Ø	Δ	∞	
052-36-060/2	0.600	35.50	78.25	300m
052-36-070/2	0.700	38.20	84.20	
052-36-080/2	0.800	41.70	91.91	
052-36-100/2	1.000	61.50	135.55	



TEKNO SALTWATER



T-Force XPS Tekno Saltwater is a super high quality nylon mono that is very different from almost any other line on the market. Its molecular structure is organized to avoid stretching and to keep a very good breaking strength. In a nutshell, it performs very close to a braided line, being really sensitive, but still keeping the good qualities of nylon monofilaments, such as a lower friction when passing through the guides and a superior manageability. The crystal blue colour and the silicon surface treatment make this line really perfect for bottom fishing from the boat and spinning.

Code	Ø	Δ	Ω
052-18-200/10	0.203	5.95	13.11
052-18-250/10	0.251	8.67	19.10
052-18-280/10	0.283	9.98	21.98
052-18-300/10	0.307	12.72	28.02
052-18-350/10	0.350	15.90	35.00
052-18-400/10	0.400	18.17	40.00
150m			
052-19-200/6	0.203	5.95	13.11
052-19-250/6	0.251	8.67	19.10
052-19-300/6	0.307	12.72	28.02
052-19-350/6	0.350	15.90	35.00
052-19-400/6	0.400	18.17	40.00
052-19-450/6	0.450	21.46	45.00
052-19-500/6	0.500	22.72	50.00
300m			

TPS



SEALION



T-Force has been always at the fore front of research and development applied to fishing line and only thanks to this continuous efforts we're able to present this hi-tech line that combines the advantages of the fluorocarbon to the characteristics of T-Force lines. The main features of the fluorocarbon coating are the low-level light refraction which makes it completely invisible in the water, the increased abrasion resistance and the super smooth surface to aid casting distance and accuracy, all combined with a low stretch. It's also totally waterproof to avoid water absorbing and maintain its breaking strength after many hours of use. Whilst the inner core guarantees a great suppleness, high knot strength and memory free. Designed primarily for saltwater fishing, both to be spooled or as a rig and hookline line.

Code	Ø	Δ	Ω
053-91-160/10	0.164	2.57	5.67
053-91-180/10	0.185	3.21	7.08
053-91-200/10	0.201	3.85	8.48
053-91-220/10	0.220	4.41	9.72
053-91-250/10	0.250	5.87	12.94
053-91-300/10	0.300	7.73	17.02
053-91-350/10	0.350	10.96	24.15
053-91-400/10	0.400	12.13	26.71
250m			



SPECIAL CASTING



As all the other lines of the T-Force series, Special Casting is parallel spooled, an exclusive production process that completely eliminates the line torsion. This version is hot red coloured, and it is recommended for sea fishing because the red colour is the first colour that disappear into the salt water, due the light refraction. It can be also used in fresh water, for those techniques that require a great line flowing for extra-long casts.



Code	Ø	Δ	Ω
052-25-160/10	0.160	3.71	8.18
052-25-180/10	0.180	4.57	10.08
052-25-200/10	0.200	5.42	11.95
052-25-250/10	0.250	8.35	18.41
052-25-300/10	0.300	11.92	26.28
052-25-350/10	0.350	15.79	34.81
052-25-400/10	0.400	20.13	44.37
052-25-450/10	0.450	27.50	60.62
052-25-500/10	0.500	34.96	77.06
150m			
052-26-160/5	0.160	3.71	8.18
052-26-180/5	0.180	4.57	10.08
052-26-200/5	0.200	5.42	11.95
052-26-250/5	0.250	8.35	18.41
052-26-300/5	0.300	11.92	26.28
052-26-350/5	0.350	15.79	34.81
300m			

FLUOROCARBON

SALTWATER



Brand new Fluorocarbon 100%, super soft and specifically designed for the most challenging techniques in salt water. Vast range of diameters, going from 0.12 to 1.00, in 50 meters spool from 0.12 to 0.50 and in 25 meters wrist spools in bigger diameters. Packaging is really interesting cause inside the PVC trade box, there is another thick plastic box with line retainer to better preserve quality line. Abrasion resistance superior specs you can't do without in saltwater, and close to total invisibility underwater.

- High Abrasion Resistance
- Superior Knot Strength
- Molecular Treatment
- Tournament Class
- Super Soft



Code	∅	△	🐟	
053-38-120/10	0.125	1.60	3.52	50m
053-38-140/10	0.145	2.10	4.63	
053-38-160/10	0.164	2.58	5.67	
053-38-180/10	0.185	3.21	7.08	
053-38-200/10	0.201	3.85	8.48	
053-38-220/10	0.220	4.41	9.72	
053-38-250/10	0.250	6.44	14.18	
053-38-280/10	0.280	7.16	15.78	

Code	∅	△	🐟	
053-38-300/10	0.300	7.72	17.02	50m
053-38-330/10	0.330	9.40	20.70	
053-38-370/10	0.370	10.97	24.15	
053-38-400/10	0.400	12.13	26.71	
053-38-450/10	0.450	13.67	30.15	
053-38-500/10	0.500	16.68	37.14	

Code	∅	△	🐟	
053-38-600/5	0.600	25.49	56.14	25m
053-38-700/5	0.700	30.75	67.73	
053-38-800/5	0.800	39.75	87.56	
053-38-900/5	0.900	45.00	99.12	
053-38-999/5	1.000	57.80	127.31	



NEW BIG GAME



Excellent big game line, packed in spools of 600 metres to take full advantage of reel's capacity with limited waste or none at all. Its light blue colour, highly dichroic, allows a perfect bait or lure presentation. The multi-layer structure is due to the most advanced Japanese technology: the high strength polymer core is wound by a first layer powered with ceramic components, which are there to bear temperature gaps. A second film takes care of abrasions and keeps out the dangerous UV rays, then the upper coating is made from special silicones which protect the line from salt, of course one of the worst enemies of any fishing line. Both linear and knot strength are particularly brilliant.

Code	∅	△	🐟	
053-07-300/6	0.30	11.34	25.01	600m
053-07-350/6	0.35	15.01	33.09	
053-07-400/6	0.40	19.14	42.20	
053-07-500/6	0.50	26.13	57.60	
053-07-600/6	0.60	33.73	74.35	
053-07-700/6	0.70	36.29	80.01	
053-07-800/6	0.80	39.62	87.34	

NEW SOFT MAX

When fishing with natural bait or lure, the leader's suppleness can make the difference between success and failure, because it can afflict bait presentation. Apart from suppleness, one of the most important features are abrasion and shock resistance, which are both offered by this new line. In fact, Soft Max has been tailor made to do that job, also because it's ultra-soft and – at the same time – shows a particularly tough surface which protects the core from aggressive agents and fish's teeth. The remarkable shock resistance comes from the programmed stretching, which helps hook's setting as well as absorb sudden hits like fast bites, which are so common in saltwater fishing. The line is crystal clear and shows a very high knot strength.

Code	∅	⚖	🐟
053-08-300/10	0.30	11.94	26.32
053-08-350/10	0.35	15.80	34.83
053-08-400/10	0.40	20.15	44.42
053-08-450/10	0.45	24.28	53.53
053-08-500/10	0.50	27.50	60.63
053-08-600/10	0.60	35.50	78.26
053-08-700/10	0.70	38.20	84.22
053-08-800/5	0.80	41.70	91.93
053-08-900/5	0.90	45.92	101.24
053-08-999/5	1.00	50.70	111.77

WIND-ON LEADER

Trabucco's high strength fluorocarbon combined with low stretch Dyna-Tex creates the strongest, most dependable wind-on leader in the world. Trabucco Wind-On Leaders are attached with a loop to loop connection

DYNA TEX XPS T FORCE

to your fishing line. The wind-on system improves bait presentation, eliminates the need for conventional long leaders and provides safer handling and releasing of fish at the boat.



Code	∅	⚖	🐟
053-21-030/5	0.58	15	30
053-21-050/5	0.68	24	50
053-21-080/5	0.92	37	80
053-21-100/5	1.02	46	100
053-21-130/5	1.22	61	135

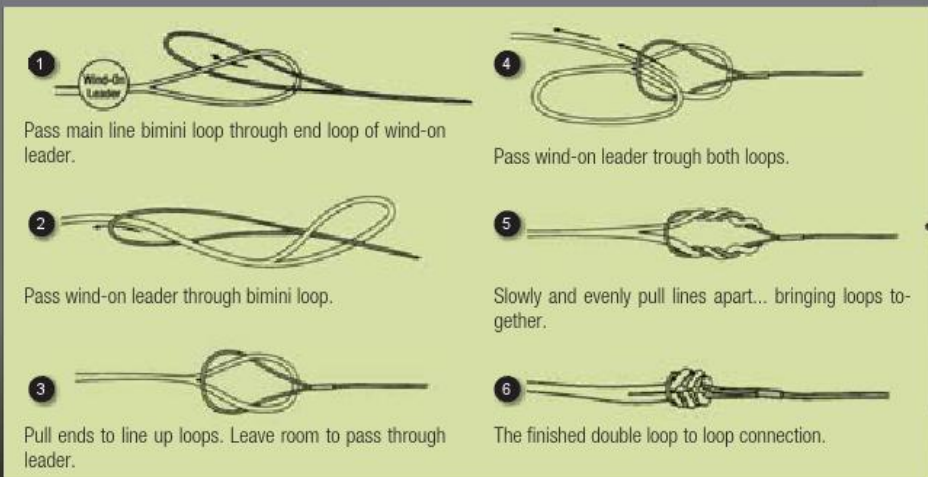

TROLLING

XPS T FORCE

Special monofilament for trolling fishing in saltwater. With a wide range of diameters and 1000 meters spool this monofilament can face any necessity when targeting big fish in the sea. Reduced stretching help to set the hook in any situation and to have total control of the fish during the fight.

Code	∅	⚖	🐟
053-18-300/4	0.300	7.25	16
053-18-350/4	0.350	9.07	20
053-18-450/4	0.450	13.60	30
053-18-600/4	0.600	22.67	50

TAPER LEADER

XPS FORCE

15 metres each tapered leaders designed for surf-casting. Exceptional abrasion-resistance to ensure prolonged use, and superior resistance to traction. These flexible coupling leaders give superior casting power and ensure the necessary resistance even with heavy sinkers.

Code	Ø	△	🐟	
053-71-018/10	0.18-0.40	4.57-20.13	10-45	15mx 10pz
053-71-020/10	0.20-0.50	5.42-27.50	12-60	
053-71-180/10	0.18-0.57	4.57-32.50	10-70	
053-71-200/10	0.20-0.57	5.42-32.50	12-70	
053-71-230/10	0.23-0.57	6.95-32.50	15-70	
053-71-260/10	0.26-0.57	8.35-32.50	18-70	

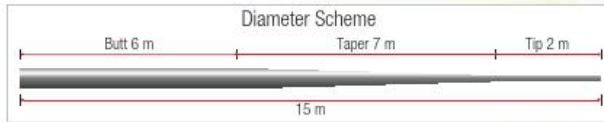

NEW LONGCAST FLUO

XPS FORCE

A nice aluminium box is the individual container of this quality line's spool: a touch of fashion but also a reliable protector from aggressive elements during the product's life, on the shop's wall as well as at user's home. The product belongs to a special family of lines, which in Japan is well known and respected by surf casters. Products with a remarkable softness, featuring a silky skin due to a secret silicone treatment. The line runs smoothly through rod's guides, with great advantage in term of casting distance. The second quality point is the high visibility, thanks to the strong colours, and Longcast Fluo follows the trend with its intense and persistent fluo orange, greatly useful in night fishing. A small sticker, applied every 150 metres, enables to draw the best from the huge spool's content.



Code	Ø	△	🐟	
053-49-180/5	0.181	4.57	10.08	1200m
053-49-200/5	0.203	5.42	11.95	
053-49-220/5	0.221	6.95	15.32	
053-49-250/5	0.251	8.35	18.41	
053-49-280/5	0.283	9.54	21.03	
053-49-300/5	0.307	11.92	26.28	
053-49-350/5	0.350	15.79	34.81	
053-49-400/5	0.400	20.13	44.38	

SURF DISTANCE

XPS FORCE

XPS Surf Casting Distance monofilament have some new and important features: the light pink colour used allows to easily detect the line, which is extremely important on this kind of fishing. In the meantime the light pink became barely visible under water, helping in all the situations with suspicious fish. We used a special manufacturing process which makes this line totally safe from saltwater, even after long use. Totally memory free and smooth, this line will make possible to reach extreme casting distance.

Code	Ø	△	🐟	
053-97-140/10	0.148	2.41	5	300m
053-97-160/10	0.165	3.01	7	
053-97-180/10	0.181	3.61	8	
053-97-200/10	0.203	4.51	10	
053-97-220/10	0.221	5.68	13	
053-97-250/10	0.251	7.03	15	
053-98-140/6	0.148	2.41	5	600m
053-98-160/6	0.165	3.01	7	
053-98-180/6	0.181	3.61	8	
053-98-200/6	0.203	4.51	10	
053-98-220/6	0.221	5.68	13	
053-98-250/6	0.251	7.03	15	



TAPER LINE

Tapered monofilament especially for surf-casting. Exceptionally resistant to abrasion and traction. The last 15m of this special monofilament are tapered on both sides to act as a flexible coupling leaders so that in the event of prolonged use or breakage of the tapered leader the monofilament can be rewound backwards onto the reel to give a perfect monofilament with tapered leader with flexible coupling again. It is knotless to eliminate the chance of breaking under tension. Sold in 10 x 250m spool packs.

Code	∅	△	♣	
053-71-018/10	0.18-0.40	4.57-20.13	10-45	250m
053-71-020/10	0.20-0.50	5.42-27.50	12-60	
053-75-180/10	0.18-0.57	4.57-27.50	10-60	
053-75-200/10	0.20-0.57	5.42-32.50	12-70	
053-75-230/10	0.23-0.57	6.95-32.50	15-70	
053-75-260/10	0.26-0.57	8.35-32.50	18-70	

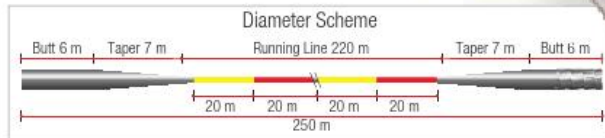

XPS FORGE



NEW VELVET PRO CAST

Code	∅	△	♣	
052-15-180/6	0.180	3.34	7.00	300m
052-15-200/6	0.200	4.13	9.00	
052-15-220/6	0.220	5.51	12.00	
052-15-250/6	0.250	6.67	15.00	
052-15-280/6	0.280	8.46	19.00	
052-15-300/6	0.300	9.14	20.00	
052-15-350/6	0.350	12.76	28.00	
052-16-180/6	0.180	3.34	7.00	600m
052-16-200/6	0.200	4.13	9.00	
052-16-220/6	0.220	5.51	12.00	
052-16-250/6	0.250	6.67	15.00	
052-16-280/6	0.280	8.46	19.00	
052-16-300/6	0.300	9.14	20.00	
052-16-350/6	0.350	12.76	28.00	

XPS FORGE



Specially developed for Surf Casting competitions, it's produced in an intense, warm yellow colour which is quite visible both under daylight and during the night, when the head lamp allows to immediately find the real direction taken by the line. Extremely soft, velvet skinned thanks to silicone treatment and without memory, it flows easily out from the reel's spool, allowing long casts and preventing the inexperienced user from creating line tangles. On the knot side, it's easy to pull tightly, even in larger diameters: on the hook's shank as well as on shock leader it creates neat and small knots. The range of diameters is wide enough to satisfy every need of the modern surf caster.

SPECIAL SEA HI-VIZ

XPS FORGE

New saltwater monofilament in white colour, available in 300 and 600 meters spool. This monofilament is mainly made for boat fishing but can be used also for fishing from the shore when high visibility lines are required. The special manufacturing process used for this line make it perfect for heavy duty fishing, like when you need to boat the fish as faster as possible or while fishing closer to rocky areas.



Code	∅	△	♣	
053-66-160/6	0.160	2.77	6	300m
053-66-180/6	0.180	3.34	7	
053-66-200/6	0.200	4.13	9	
053-66-220/6	0.220	5.51	12	
053-66-250/6	0.250	6.67	15	
053-66-280/6	0.280	8.46	19	
053-66-300/6	0.300	9.14	20	
053-66-350/6	0.350	12.76	28	
053-67-160/6	0.160	2.77	6	600m
053-67-180/6	0.180	3.34	7	
053-67-200/6	0.200	4.13	9	
053-67-220/6	0.220	5.51	12	
053-67-250/6	0.250	6.67	15	
053-67-280/6	0.280	8.46	19	
053-67-300/6	0.300	9.14	20	
053-67-350/6	0.350	12.76	28	

SURF CASTING

A surf-casting monofilament extremely soft with a total absence of memory. It allows longer and precise casting of any other monofilaments in the market. The special covering by a new silicone coating, makes it impermeable and unassailable from the sea agents.

TPS

Code	∅	△	🐟
053-47-180/6	0.181	4.65	10.24
053-47-200/6	0.203	5.50	12.34
053-47-220/6	0.228	6.46	14.23
053-47-250/6	0.255	8.46	18.63
053-47-280/6	0.282	9.65	21.26
053-47-300/6	0.309	12.07	26.59
053-47-350/6	0.350	14.40	31.72
053-47-400/6	0.400	18.90	41.63

300m



XPS S-FORCE JAPAN

LONG CAST

TPS



Code	∅	△	🐟
052-80-180/10	0.180	4.55	10.03
052-80-200/10	0.200	5.55	12.24
052-80-220/10	0.220	6.95	15.32
052-80-250/10	0.250	8.44	18.61
052-80-300/10	0.300	12.06	26.58
052-80-350/10	0.350	15.85	34.94
052-80-400/10	0.400	20.20	44.53
052-80-450/10	0.450	27.50	60.62

150m

300m

This line has been developed for those anglers that need to make very long casts. The color fluo-yellow is immediately visible for the angler, but it is almost invisible into the water. This line has a very good flowing qualities, high abrasion resistance and it is super soft, a combination of factors that allow this line to be the best in terms of casting

capacity. The very low elasticity allows the angler to be always in close contact with the bait and transmit an immediate strike on the bite. It is completely waterproof, like all the S-Force monofilaments, and as well as saltproof. Available in spools of 150 and 300 mts in individual box.

LONG CAST CARP

S-FORCE JAPAN

Monofilament especially developed for long distance night fishing. Thanks to the particular composition and the colour yellow-fluo crayon, results in very high visibility at night or in poor light. This version features good fluidity, thanks to the spooling system and particularly the silicone coating that reduces the resistance allowing longer casts. Low elasticity maintains an immediate contact with the bait and the hooked fish. Excellent abrasion resistance and strength under tension.



Code	∅	△	🐟
052-20-260/5	0.260	8.77	19.32
052-20-280/5	0.280	10.85	24.13
052-20-300/5	0.300	12.06	26.58
052-20-320/5	0.320	13.98	30.80
052-20-350/5	0.350	15.85	32.22

500m

TPS

SOFT CARP HV

S-FORCE JAPAN

The main characteristic of this mono is the fluorescent green coloration, that makes it visible to the angler in any conditions whilst also maintaining a good low visibility in the water. The surface silicon treatment, drastically reduces line abrasion, guaranteeing a long life duration without equal. The absence of memory and the softness ensure correct and smooth line travel from the spool during casting, enabling longer and more accurate casts. To further improve the performance a new parallel spooling system has been adopted, that eliminates uneven tensions in the production phase.



Code	∅	△	🐟
052-23-260/5	0.260	8.77	19.32
052-23-280/5	0.280	10.85	24.13
052-23-300/5	0.300	12.06	26.58
052-23-320/5	0.320	13.98	30.80
052-23-350/5	0.350	15.85	32.22

500m

TPS

TPS



SINKING

One of the best selling line in Europe for carp-fishing, feeder and waggler fishing. The surface is treated with a special silicon coating that completely seals the line by the water absorption, and the controlled stretch grade allows to immediate strikes even when fishing at long distance. The pastel brown color is perfectly mimetic on all kind of bottom ground type.

Code	∅	Δ	🐟	
052-95-160/10	0.160	2.10	4.63	150m
052-95-180/10	0.180	2.80	6.18	
052-95-200/10	0.200	3.70	8.16	
052-95-220/10	0.220	6.95	15.32	
052-95-250/10	0.250	8.44	18.61	
052-95-300/10	0.300	9.80	21.60	300m
052-96-200/5	0.200	3.70	8.16	
052-96-250/5	0.250	8.44	18.61	
052-96-280/5	0.280	6.95	15.32	
052-96-300/5	0.300	9.80	21.60	
052-96-320/5	0.320	10.86	24.13	
052-96-350/5	0.350	15.85	34.94	

TPS



RIVER TROUT

Code	∅	Δ	🐟	
052-90-160/10	0.160	3.70	8.16	150m
052-90-180/10	0.180	4.55	10.03	
052-90-200/10	0.200	5.55	12.24	
052-90-220/10	0.220	6.95	15.32	
052-90-250/10	0.250	8.44	18.61	
052-90-280/10	0.280	10.86	24.13	
052-90-300/10	0.300	12.06	26.58	
052-90-350/10	0.350	15.85	35.22	
052-90-400/10	0.400	20.20	44.53	

By the name of this version it is clearly indicated the recommended use. It is an ideal line for spinning, with a pastel milky white colour that allows the angler to follow the bait during the fishing action, but that remain invisible down the water for the particular low grade of light refraction. The great softness allows the angler to accurate and long casts and the controlled stretch grade keep the contact with the bait always under a direct an immediate control.

The great softness allows the angler to accurate and long casts and the controlled stretch grade keep the contact with the bait always under a direct an immediate control.

LAKE TROUT

Code	∅	Δ	🐟	
052-85-160/10	0.160	3.70	8.16	150m
052-85-180/10	0.180	4.55	10.03	
052-85-200/10	0.200	5.55	12.24	
052-85-220/10	0.220	6.95	15.32	
052-85-250/10	0.250	8.44	18.16	

This version of S-Force has been developed for trout fishing with the special style of "bombarda", those special floats typically used in Italy but now spreading

in all Europe. The particular structure gives a very low memory to the line but offers as well a great softness. It is completely waterproof, and it keeps all the technical prerogatives also in extreme cold waters. The color is a new pastel violet, immediately visible out of the water but almost invisible in depth.



MATCH SINKING

One of the best-selling line of the range. The special coating based on silicon, give to this line a great fluidity during the cast, assuring to angler much longer casts and a long lasting. Once experienced one of our S-Force lines, you will never come back to another line. The main features of this particular version is the controlled stretch capacity and the sinking quality, as well as an unbelievable and complete absence of memory. It is a line highly recommended for waggler and feeder fishing. The colour is a very dark blue, nearly black, and it is parallel spooled.

Code	∅	Δ	🐟	
053-00-120/10	0.120	2.10	4.63	150m
053-00-140/10	0.140	2.80	6.18	
053-00-160/10	0.160	3.70	8.16	
053-00-180/10	0.180	4.55	10.03	
053-00-200/10	0.200	5.55	12.24	
053-00-250/10	0.250	8.44	18.61	
053-00-300/10	0.300	12.06	26.58	

TPS



T1 TOURNAMENT

SUPER ELITE

This is an evolution of the T1 monofilament, created for the pole fishing. It is highly recommended for the preparation of rigs and hook lengths. It has a high breaking strength, superior to any other line in the market.

Code	∅	⚖	🐟	
058-50-060/10	0.060	0.80	1.76	50m
058-50-070/10	0.070	1.16	2.55	
058-50-080/10	0.080	1.33	2.92	
058-50-090/10	0.090	1.68	3.70	
058-50-100/10	0.100	2.05	4.51	
058-50-110/10	0.110	2.70	5.94	
058-50-120/10	0.120	3.10	6.82	
058-50-140/10	0.140	3.90	8.60	
058-50-160/10	0.160	5.10	11.23	
058-50-180/10	0.180	6.30	13.87	
058-50-200/10	0.200	7.40	16.30	



T1 FLUORINE



The Super Elite Fluorine is a Japanese monofilament that is made through an exclusive process that is actually able

T1 CARP FISHERY

SUPER ELITE

Another special version of the T1 series, specific for the use in commercial carp fisheries. It has an unbelievable linear strength and knot strength, that remain unchanged also when the line is wet.

Code	∅	⚖	🐟	
058-60-100/10	0.100	2.25	4.05	50m
058-60-110/10	0.110	2.90	6.38	
058-60-120/10	0.120	3.25	7.15	
058-60-140/10	0.140	4.10	9.30	
058-60-160/10	0.160	5.30	11.67	
058-60-180/10	0.180	6.50	14.30	
058-60-200/10	0.200	7.65	16.85	



T1 MICRO



SUPER TOURNAMENT

SUPER ELITE

New generation monofilament, featuring the highest abrasion resistance available in the market. It is spooled using the new "parallel" Japanese technology, that eliminates the line torsion during the production process. In order to help this particular spooling system

TPS

Code	∅	⚖	🐟	
058-70-200/10	0.205	5.50	12.13	150m
058-70-250/10	0.255	8.40	18.52	
058-70-300/10	0.300	12.00	26.45	
058-70-350/10	0.350	15.85	34.94	
058-70-400/10	0.400	20.20	44.53	
058-70-450/10	0.450	27.50	60.62	
058-70-500/10	0.500	35.00	77.15	

we have used a special shaped spool, with a very large diameter, and covered by a lid that protect the line by the sun rays. It is recommended for all uses in fresh or sea fishing in which the reel is used.

Code	∅	⚖	🐟	
058-71-200/5	0.205	5.50	12.13	300m
058-71-250/5	0.255	8.40	18.52	
058-71-300/5	0.300	12.00	26.45	
058-71-350/5	0.350	15.85	34.94	
058-71-400/5	0.400	20.20	44.53	
058-71-450/5	0.450	27.50	60.62	
058-71-500/5	0.500	35.00	77.15	



CAMO CAST

SUPER ELITE

Very rigid mono, created for the long distance fishing, in which is highly important to have a close contact with the bait. Very high abrasion resistant and breaking/knot strength superior to any other similar monofilament.

TPS

Code	∅	⚖	🐟	
058-80-140/10	0.148	2.80	6.18	150m
058-80-160/10	0.165	3.75	8.27	
058-80-180/10	0.185	4.60	10.14	
058-80-200/10	0.205	5.50	12.13	
058-80-250/10	0.255	8.40	18.52	
058-80-300/10	0.300	12.00	26.45	
058-80-350/10	0.350	15.85	34.94	
058-80-400/10	0.400	20.20	44.53	
058-80-500/10	0.500	35.00	77.15	

The colour is a mix of light green and violet, that creates a camouflage effect to makes this line invisible on any kind of bottom. It is recommended for feeder, carp fishing and spinning. Spooled with the an extra-large spools to reduce coils.

Code	∅	⚖	🐟	
058-81-140/5	0.148	2.80	6.18	300m
058-81-160/5	0.165	3.75	8.27	
058-81-180/5	0.185	4.60	10.14	
058-81-200/5	0.205	5.50	12.13	
058-81-250/5	0.255	8.40	18.52	
058-81-300/5	0.300	12.00	26.45	
058-81-350/5	0.350	15.85	34.94	
058-81-400/5	0.400	20.20	44.53	
058-81-500/5	0.500	35.00	77.15	



SUPER ELITE

to mix deep into the matrix both nylon and fluorocarbon, thus creating a kind of hybrid that can take every advantage from both its components. It features a specific gravity superior to water and it is lower visible underwater than a plain nylon, but not as it can be a 100% fluorocarbon line. At the same time Fluorine is stronger than 100% fluorocarbon but a little weaker if compared to plain nylon.

Code	∅	⚖	🐟	50m
058-58-080/10	0.08	1.150	2.53	
058-58-100/10	0.10	1.700	3.75	
058-58-120/10	0.12	2.300	5.07	
058-58-140/10	0.14	3.350	7.38	
058-58-160/10	0.16	4.290	9.43	
058-58-180/10	0.18	5.380	11.85	
058-58-200/10	0.20	6.500	14.32	

SUPER ELITE

Super high quality nylon monofilament, for bolo and rig making, as in the tradition of Super Elite series, with a remarkable high strength that is not harmed from knots. Diameters are guaranteed constant through a continuous electronic check during line extrusion process.

Code	∅	⚖	🐟	100m
058-55-100/10	0.10	1.700	3.75	
058-55-120/10	0.12	2.270	5.00	
058-55-140/10	0.14	3.310	7.30	
058-55-160/10	0.16	4.230	9.30	
058-55-180/10	0.18	5.350	11.80	
058-55-200/10	0.20	6.470	14.20	



SPECTRUM  *Diamond*

It is the first monofilament that started the use of the fluorocarbon, since 1996. It is absolutely invisible, soft and with a fantastic knot strength. It is the most used line by match-anglers all over the world.

Code	∅	⚖	🐟	50m
FF 0012 00 08/10	0.080	0.85	1.87	
FF 0012 00 10/10	0.100	1.25	2.76	
FF 0012 00 12/10	0.120	1.75	3.85	
FF 0012 00 14/10	0.140	2.30	5.07	
FF 0012 00 16/10	0.160	2.95	6.51	



FLUORO CARBON  *Diamond*

This monofilament is one of the few in the world processed only using pure fluorocarbon. It is soft, abrasion resistant, fast sinking and most of all is totally invisible in the water. The diameters are accurate, ideal for hook lengths. Available in spools of 50m also in big diameters that are almost impossible to find in the market and that are highly recommended for fly and sea fishing.

Code	∅	⚖	🐟	50m
059-10-010/10	0.072	0.53	1.16	
059-10-020/10	0.084	0.77	1.70	
059-10-030/10	0.094	0.92	2.03	
059-10-040/10	0.104	1.08	2.39	
059-10-050/10	0.112	1.35	2.99	
059-10-060/10	0.125	1.75	3.87	
059-10-070/10	0.145	2.00	4.43	
059-10-080/10	0.164	2.80	6.18	
059-10-090/10	0.185	3.30	7.28	
059-10-100/10	0.205	3.80	8.38	
059-10-110/10	0.245	5.20	11.47	
059-10-120/10	0.280	6.70	14.78	
059-10-130/10	0.320	8.20	18.07	
059-10-140/10	0.370	10.30	22.70	

SINKING  *Diamond*

Special version developed for the waggler fishing, featuring a total absence of memory. It has a great breaking strength and is very fast sinking. Without any doubt, this is the best sinking line ever produced.

Code	∅	⚖	🐟	500m
FF 0012 05 12	0.120	1.45	3.20	
FF 0012 05 14	0.140	1.95	4.30	
FF 0012 05 15	0.150	2.42	5.34	
FF 0012 05 16	0.160	2.80	6.17	
FF 0012 05 18	0.180	3.40	7.50	

RACE PRO

This version of Diamond has been developed for those anglers that require a large quantity of line to spool many reels or for rig making. It has a great knot strength and low memory. It is crystal light blue colour.

Code	∅	⚖	🐟	1000m
058-35-100/6	0.100	2.20	4.85	
058-35-120/6	0.120	2.94	6.48	
058-35-140/6	0.140	3.54	7.81	
058-35-160/6	0.160	4.20	9.26	
058-35-180/6	0.180	5.30	11.69	
058-35-200/6	0.200	6.25	13.78	

Code	∅	⚖	🐟	
058-35-220/6	0.220	7.20	15.87	900m
058-35-250/6	0.250	8.15	17.97	850m
058-35-300/6	0.300	10.50	23.15	750m



 *Diamond*





Gianluigi Sorti

NEW MAX PLUS ALLROUND

This line can be employed both on the reel and to make rigs, thanks to his low memory and high abrasion resistance. Those factors generate a great knot strength, because knot's coils can be much tightened without risking that they damage each other. Beyond the technical specifications, the Max Plus Allround shows an incredible value for money. The product is suitable for any fishing style, both in fresh and saltwater, and is packed in 150, 300 and 1000 metres spools protected by a special cover which protects line from UV rays and enables the retailer to easily hang them on to the shop's display wall. Colour is light transparent green.



Code	∅	⚖	🐟	
057-00-120/10	0.12	1.50	3.30	150m
057-00-140/10	0.14	2.10	4.63	
057-00-160/10	0.16	2.65	5.84	
057-00-180/10	0.18	3.20	7.05	
057-00-200/10	0.20	4.00	8.81	
057-00-250/10	0.25	5.80	12.78	
057-00-300/10	0.30	8.50	18.72	
057-00-350/10	0.35	10.50	23.13	
057-00-400/10	0.40	13.50	29.74	
057-00-450/10	0.45	15.00	33.06	
057-00-500/10	0.50	18.00	39.68	

Code	∅	⚖	🐟	
057-01-160/10	0.16	2.65	5.84	300m
057-01-180/10	0.18	3.20	7.05	
057-01-200/10	0.20	4.00	8.81	
057-01-250/10	0.25	5.80	12.78	
057-01-300/10	0.30	8.50	18.72	
057-01-350/10	0.35	10.50	23.13	
057-01-400/10	0.40	13.50	29.74	

Code	∅	⚖	🐟	
057-15-160/2	0.16	2.65	5.84	1000m
057-15-180/2	0.18	3.20	7.05	
057-15-200/2	0.20	4.00	8.81	
057-15-250/2	0.25	5.80	12.78	
057-15-300/2	0.30	8.50	18.72	
057-15-350/2	0.35	10.50	23.13	
057-15-400/2	0.40	13.50	29.74	

NEW MAX PLUS BOLO

New line featuring an amazing abrasion resistance, thus protected against shot's pressure, rod's guides friction and sliding floats rubbing. In addition, this product is notably soft and memory free, specifications which produce a smooth flow during casting. The wide and soft coils are a real advantage, specially when the rod is wet due to rain or water droplets at sea side, because the contact points are down to the minimum. Max Plus Bolo is packed in the classic 150 m spools, featuring a shell which both allows hanging it to display boards and protects line from sun light. The colour is transparent light purple.



Code	∅	⚖	🐟	
057-12-140/10	0.14	2.10	4.63	150m
057-12-160/10	0.16	2.65	5.84	
057-12-180/10	0.18	3.20	7.05	
057-12-200/10	0.20	4.00	8.81	
057-12-250/10	0.25	5.80	12.78	
057-12-300/10	0.30	8.50	18.72	

NEW MAX PLUS CARP

The new Max Plus Carp is a highly specialized line, mainly oriented to big fish hunting thanks to his huge abrasion resistance and knot strength. In addition, the low memory and reduced stretch at low fast and accurate strikes, as well as an improved bite detection. The brown, dichroic colour is quite mimetic in most water environments, thus ideal for big carp fishing. The value for money is really attractive, as well as the packaging; in fact, the product is presented in 150 and 300 metres spools, with a side shell which filters UV rays and also include the slot destined to hang on to shop's display panel.



Code	∅	⚖	🐟
057-04-200/10	0.20	4.00	8.81
057-04-220/10	0.22	4.90	10.79
057-04-250/10	0.25	5.80	12.78
057-04-280/10	0.28	6.85	15.09
057-04-300/10	0.30	8.50	18.72
057-04-350/10	0.35	10.50	23.13
057-04-400/10	0.40	13.50	29.74
057-04-450/10	0.45	15.00	33.06
057-04-500/10	0.50	18.00	39.68

Code	∅	⚖	🐟
057-05-200/10	0.20	4.00	8.81
057-05-220/10	0.22	4.90	10.79
057-05-250/10	0.25	5.80	12.78
057-05-280/10	0.28	6.85	15.09
057-05-300/10	0.30	8.50	18.72
057-05-350/10	0.35	10.50	23.13
057-05-400/10	0.40	13.50	29.74

XP Line

CARP

Code	∅	⚖	🐟
057-89-925	0.250	5.80	12.78
057-89-928	0.280	6.85	15.09
057-89-930	0.300	8.50	18.72
057-89-935	0.350	10.50	23.13
057-89-940	0.400	13.50	29.74



NEW MAX PLUS SPECIMEN

The perfect line for match and feeder fishing, designed through a special formula which enabled to get a product featuring high gravity, thus sinking and stiff. The surface treatment provides high abrasion resistance, very low memory and stretch, plus high knot strength. Packed in 150 metres spools, it's protected from UV rays during its shelf life, because the special side protection filters light. The glossy black colour helps the user to see where the fish goes during the fight. The product shows an interesting value for money.



Code	∅	⚖	🐟
057-06-160/10	0.16	2.65	5.84
057-06-180/10	0.18	3.20	7.05
057-06-200/10	0.20	4.00	8.81
057-06-250/10	0.25	5.80	12.78
057-06-300/10	0.30	8.50	18.72
057-06-350/10	0.35	10.50	23.13
057-06-400/10	0.40	13.50	29.74

NEW MAX PLUS SPINNING

This new line has been specifically designed for spinning, where it does the job thanks to its very low stretch. This specification generates a greater sensitivity, offering to the user a neat perception of lure movements and contacts with underwater structures, as well as quick and neat strikes, even in difficult conditions. Providing extreme linear strength, at the same time it is particularly soft to ease accurate casting. Coloured in dark green, it's packed in the traditional 150 m spools, featuring a protective shell which keeps UV rays off and includes the hole to hang it on shop's display wall.

Code	∅	⚖	🐟
057-08-160/10	0.16	2.65	5.84
057-08-180/10	0.18	3.20	7.05
057-08-200/10	0.20	4.00	8.81
057-08-250/10	0.25	5.80	12.78
057-08-300/10	0.30	8.50	18.72
057-08-350/10	0.35	10.50	23.13
057-08-400/10	0.40	13.50	29.74



NEW MAX PLUS PHANTOM

Phantom is the "ghost" line within Max Plus range. His crystal clear color makes it almost invisible in water, practically performing like the universal solution for all reel fishing styles, also giving the best in case the straight line is a must (without hooklink). Other relevant merits are high abrasion resistance and knot strength, along with a nice smoothness, always a good asset in term of bait presentation. Undoubtedly, the whole specification list draws the attention of sea boat experts, as they can use it to make perfect multiple hook's rigs. The line is offered in 150, 300 and 1000 m spools, with a surprising value for money and with a nice cover which acts as UV rays protector and include a slot for the application on to shop's display boards.



Code	Ø	⚖	🐟
057-02-120/10	0.12	1.50	3.30
057-02-140/10	0.14	2.10	4.63
057-02-160/10	0.16	2.65	5.84
057-02-180/10	0.18	3.20	7.05
057-02-200/10	0.20	4.00	8.81
057-02-200/10	0.22	4.90	10.79
057-02-250/10	0.25	5.80	12.78
057-02-300/10	0.30	8.50	18.72
057-02-350/10	0.35	10.50	23.13
057-02-400/10	0.40	13.50	29.74
057-02-450/10	0.45	15.00	33.06
057-02-500/10	0.50	18.00	39.68

150m

Code	Ø	⚖	🐟
057-03-180/10	0.18	3.20	7.05
057-03-200/10	0.20	4.00	8.81
057-03-220/10	0.22	4.90	10.79
057-03-250/10	0.25	5.80	12.78
057-03-300/10	0.30	8.50	18.72
057-03-350/10	0.35	10.50	23.13
057-03-400/10	0.40	13.50	29.74

300m

Code	Ø	⚖	🐟
057-16-180/2	0.18	3.20	7.05
057-16-200/2	0.20	4.00	8.81
057-16-220/2	0.22	4.90	10.79
057-16-250/2	0.25	5.80	12.78
057-16-300/2	0.30	8.50	18.72
057-16-350/2	0.35	10.50	23.13
057-16-400/2	0.40	13.50	29.74
057-16-500/2	0.50	18.00	39.68
057-16-600/2	0.60	23.00	50.66

1000m



Ivan Lazovic

XP LINE BLUE SEA

A perfect transparent blue monofilament for fishing in all type of the clear waters. The special superficial treatment of the polymers, makes it extremely flowing already improving subsequently its high resistance to the abrasion. The line comes spooled in parallel system, to eliminate the torsions during the production process.

Code	Ø	⚖	🐟
058-00-180/10	0.180	3.20	7.05
058-00-200/10	0.200	4.00	8.81
058-00-220/10	0.220	4.90	10.79
058-00-250/10	0.250	5.80	12.78
058-00-300/10	0.300	8.50	18.72
058-00-350/10	0.350	10.50	23.13
058-00-400/10	0.400	13.50	29.74
058-00-500/10	0.500	18.00	39.65

300m



Saverio Rosa



NEW MAX PLUS SUPER SEA

Coloured in light blue, it's the perfect line for sea fishing, even when water is particularly clear. The extremely high abrasion resistance is further enhanced by a surface treatment which makes it very smooth and protects it from aggressive agents such as sun light and salt water. The outstanding softness also helps knot's tightening, which become very small. Wide range of packing, with standard spools of 150 and 300 m, plus the 1000 m version for the intensive users, all featuring the side shield which include the hole to hang them up on to shop's display boards.



Code	∅	⚖	🐟	
057-10-160/10	0.16	2.65	5.84	150m
057-10-180/10	0.18	3.20	7.05	
057-10-200/10	0.20	4.00	8.81	
057-10-220/10	0.22	4.90	10.79	
057-10-250/10	0.25	5.80	12.78	
057-10-300/10	0.30	8.50	18.72	
057-10-350/10	0.35	10.50	23.13	
057-10-400/10	0.40	13.50	29.74	
057-10-450/10	0.45	15.00	33.06	
057-10-500/10	0.50	18.00	39.68	

Code	∅	⚖	🐟	
057-13-200/10	0.20	4.00	8.81	300m
057-13-220/10	0.22	4.90	10.79	
057-13-250/10	0.25	5.80	12.78	
057-13-300/10	0.30	8.50	18.72	
057-13-350/10	0.35	10.50	23.13	
057-13-400/10	0.40	13.50	29.74	
057-13-500/10	0.50	18.00	39.68	

Code	∅	⚖	🐟	
057-17-200/2	0.20	4.00	8.81	1000m
057-17-220/2	0.22	4.90	10.79	
057-17-250/2	0.25	5.80	12.78	
057-17-300/2	0.30	8.50	18.72	
057-17-350/2	0.35	10.50	23.13	
057-17-400/2	0.40	13.50	29.74	
057-17-500/2	0.50	18.00	39.68	

XP LINE FLOW CASTING

New generation monofilament with a very high resistance to the abrasion. Spooled in parallel, system that totally eliminates the torsion in the productive phase, with consequent best fluidity of the monofilament during the casting. This model has the particularity to be extremely soft and with high resistance to the traction. Excellent for surf casting fishing in the sea and in the fresh water when need high visibility. Fluorescent colour.

Code	∅	⚖	🐟	
058-05-180/10	0.180	3.20	7.05	150m
058-05-200/10	0.200	4.00	8.81	
058-05-220/10	0.220	4.90	10.79	
058-05-250/10	0.250	5.80	12.78	
058-05-300/10	0.300	8.50	18.72	
058-05-350/10	0.350	10.50	23.13	
058-05-400/10	0.400	13.50	29.74	
058-07-180/10	0.180	3.20	7.05	300m
058-07-200/10	0.200	4.00	8.81	
058-07-220/10	0.220	4.90	10.79	
058-07-250/10	0.250	5.80	12.78	
058-07-300/10	0.300	8.50	18.72	
058-07-350/10	0.350	10.50	23.13	
058-07-400/10	0.400	13.50	29.74	
058-07-500/10	0.500	18.00	39.65	



XPS SUPERCARBON HOOKS

LASER SHARP POINT

Extra Performance Series is the name of Trabucco quality hooks developed for top match anglers, which now gets much wider also touching different segments such as feeder fishing, commercial carping, trout fishing, light drifting and beach ledgering.

In line with existing series, also the new ones display "extra performance", because the extreme quality is not only achieved with the development of new shapes, but also through the employed materials, the finish and functional details. The strength/lightness ratio has been tailored size by size, taking advantage of the special hi-carbon content steel, which is only available in Japan, where these fantastic hooks are produced under strict quality control. All points are chemically sharpened, then further finished by laser to get absolute perfection and durability.

NEW



NEW 120 XN

N Nickel **●** Regular

This pattern is well known all over Europe since when the carbon content steel was unknown in the fishing tackle industry. From roach to mullets, from eels to soles, it has caught so many species both in fresh and salt waters, showing great efficiency when baited up and while removed from fish mouth. It's popularity is certainly also due to the long point, parallel to shank, and to the narrow ankle which provide bait and fish hold. All bait which are normally pushed on to the shank are finely matching it: from pinkies and squatts to earthworms in freshwater; from anchovy fillet to shrimp's tail in the saltwater.

Code	021-68.../10									
Size	04	06	08	10	12	14	16	18	20	22
Wire Ø	0.81	0.64	0.56	0.53	0.48	0.46	0.36	0.36	0.30	0.30
Pcs/Bag	25	25	25	25	25	25	25	25	25	25



4...040 6...060 8...080 10...100 12...120 14...140 16...160 18...180 20...200 22...220

NEW 121 XB

BR Bronzed **🔨** Forged **🔪** MicroBarb

Its code recalls the classic 120, as its shape comes from long shank popularity, but its strength is stepped up. In fact the wire thickness is oversized, thus the point has a wide base which enables it to bear stress and torsion inevitably generated during those long fights with big fish. Maggots, casters and worms are the ideal baits for it to catch chub, carp and huge bream, both on the pole and on waggler or feeder rods. No need to add a big barb on such strong point: that's why Trabucco team opted for micro barb instead.

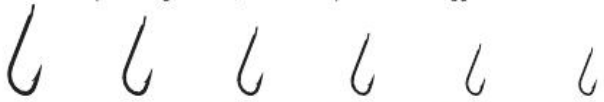

Code	021-60... / 10					
Size	12	14	16	18	20	22
Wire Ø	0.43	0.41	0.38	0.36	0.33	0.30
Pcs/Bag	25	25	25	25	25	25

12...120 14...140 16...160 18...180 20...200 22...220

NEW 110XN & 110XK

● Regular **🔪** MicroBarb

The great hooking efficiency and the extreme strength are the reason why this pattern is extremely popular all over Europe. As a matter of fact, this is the hook used by Goran Radovic, 2014 World Champion, for his fantastic pole show with many big barbel caught in fast running water. The long, ultra-sharp point with beak profile provides quick and deep penetration also in the hardest mouths, with the narrow ankle ensuring that fish can't get rid of the hook. With maggots and worms is a brilliant partner for pole, bolo, waggler and feeder rods. It is offered in two different finish: nickel and black nickel.



N Nickel						BN Black Nickel					
Code						Code					
Size						Size					
Wire Ø						Wire Ø					
Pcs/Bag						Pcs/Bag					
10	12	14	16	18		10	12	14	16	18	
0.60	0.53	0.46	0.41	0.37		0.60	0.53	0.46	0.41	0.37	
25	25	25	25	25		25	25	25	25	25	

N/BN 10...100 12...120 14...140 16...160 18...180

XPS

INNOVATIVE PACKAGING

The new bags contain 25 hooks to keep the individual price as low as possible. Their design has been cared in every detail, with upper part of the card changing main colour according to hook's finish, while the lower portion is almost free from decorations to allow the best possible visibility of the product inside. In order to enable the consumer to quickly identify the hook's shape, it has been printed in a dedicated cell. For the first time ever, also wire diameter is indicated on each bag, so that the user can evaluate the strength level, maybe making comparisons between different series.



IN THE SHOP

Every 10 bags of hooks, the retailer will find a back card showing the product's item number. Such card should take place on the display wall, beyond hook's bags, and will be useful to place an order when he will run out of stock.



NEW 631XB & 631XK

For all match anglers across Europe this pattern is a must since the eighties, and its popularity is probably second to none, thanks to the extreme efficiency in many conditions. The wide, round bend can accommodate several baits like maggots, casters worms, sweetcorn, punched bread and all their cocktails. Good for waggler and feeder fishing, has shown great chances with the bolognese and pole, too. Trabucco offers it in two different finish: bronzed and black nickel.



BR Bronzed

BN Black Nickel

Code	021-38... / 10						
Size	10	12	14	16	18	20	22
Wire Ø	0.48	0.41	0.39	0.33	0.28	0.21	0.21
Pcs/Bag	25	25	25	25	25	25	25

Code	021-40... / 10						
Size	10	12	14	16	18	20	22
Wire Ø	0.48	0.41	0.39	0.33	0.28	0.21	0.21
Pcs/Bag	25	25	25	25	25	25	25



BR/BN 10...100 12...120 14...140 16...160 18...180 20...200 22...220

NEW 410XN

N Nickel Regular MicroBarb

An extra-fine version of series 631, it keeps the round, wide bend and the long point, but it's even more match fishing oriented thanks to the fine wire, which enables to obtain perfect presentation when fish are particularly shy. Also the shank's length has been changed, opting for a longer lever which improves strike's efficiency very much. In case of sea match fishing with telescopic poles or bolognese rods, such shank helps saving hooklinks from fish teeth. The micro barb does not damage the delicate worms like bloodworm and is also perfect for bread punch canal fishing.



14...140 16...160 18...180 20...200 22...220

Code	021-62... / 10				
Size	14	16	18	20	22
Wire Ø	0.32	0.28	0.26	0.25	0.22
Pcs/Bag	25	25	25	25	25



Above, a single caster perfectly presented on a 631XB hook; below, a nice scardola caught by Gianluigi Sorti on the river Mincio around Peschiera del Garda.

NEW 635XB

BR Bronzed Regular MicroBarb

Among many variations of the classic 631, now available in the market, this genuine one from Trabucco offers an incredible strength to catch big fish with small bait like single maggot, casters and worms. Compared to the standard 631 pattern, its wire is oversized and point is much longer, a detail which the experts regard as very important. The micro barb does not damage the living baits, with the obvious advantages in terms of catches. Nowadays, match venues are subject to extreme pressure, so the fish are more and more careful in front of big hookbaits and quite often pick up very small ones. Try it, and you will understand why we forecast a great success for this series.



14...140 16...160 18...180 20...200 22...220

Code	021-66... / 10				
Size	14	16	18	20	22
Wire Ø	0.38	0.30	0.28	0.25	0.23
Pcs/Bag	25	25	25	25	25



SYMBOLS 1 Hook Size ...020 Produc Code

NEW 701XK

BN Black Nickel Forged Barbless

More and more match anglers now understand the great advantages of barbless hooks, which really can improve catch rates not only with the pole, but also with bolo, match and even feeder rods. All the words spent by experts, journalists and match winners about natural presentation immediately come into reality when somebody tries hooks like this 701XK by Trabucco. Both living baits and fighting fish are held by hook's ankle, a vital part of the design because all stress and hooking power get through it. Problems greatly solved by a slightly forged curve and an in-turned point.



12...120 14...140 16...160 18...180 20...200 22...220 24...240

Code	021-34... / 10						
Size	12	14	16	18	20	22	24
Wire Ø	0.41	0.37	0.30	0.28	0.26	0.23	0.21
Pcs/Bag	25	25	25	25	25	25	25

NEW 415XB

BR Bronzed Regular MicroBarb

An excellent match hook, destined to high grade anglers who can draw the best from it by fine elasticate of their poles. In fact, lightness is its best merit, and this factor puts the 415XB on top of roach and bream hooks, which are known to be very careful when picking up any bait which is presented in unnatural way. Before float's antenna shows any sign of life, they reject the hookbait, which is left damaged and surely cannot produce another bite! The micro barb is a must to limit the damage to delicate living baits like bloodworm, maggots and small worms.

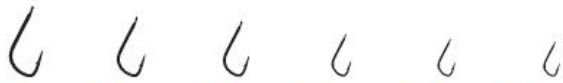

14...140 16...160 18...180 20...200 22...220 24...240

Code	021-30... / 10						
Size	14	16	18	20	22	24	
Wire Ø	0.37	0.30	0.28	0.26	0.23	0.21	
Pcs/Bag	25	25	25	25	25	25	

NEW 210XB

BR Bronzed Regular MicroBarb

Specially developed for tough match conditions, when sudden hookbait change can produce unexpected bites. That's why this series has been designed with medium wire and with a wide gape which can allow to alternate different bait without replacing the hook. Therefore, a bunch of maggots can leave the place to a sweetcorn grain, or to a worm and caster cocktail, or even to several, small worms to form a sort of octopus. Practically, the angler can go for colour contrast or stimulate the attack by wriggling baits. A true allrounder which can't miss in a serious seatbox.



10...100 12...120 14...140 16...160 18...180 20...200 22...220

Code	021-64... / 10						
Size	10	12	14	16	18	20	22
Wire Ø	0.43	0.39	0.35	0.33	0.30	0.26	0.23
Pcs/Bag	25	25	25	25	25	25	25

NEW 440XN

N Nickel Regular

A great balance between lightness and strength is the secret of this allround hook series, which is perfect to match a wide variety of baits: from maggots to worms, from bread to sweetcorn, from natural honey worms to silicone ones which nowadays are getting more and more popular among trout anglers. The ankle is there to keep the hookbait into correct position, and this is more important in case of trout fishing, because the whole thing must actually rotate during retrieve. On normal hooks, the hookbait tend to slide down the bend, affecting the rotation: this is not the case with 440XN.



6...060 7...070 8...080 10...100 12...120 14...140 16...160 18...180

Code	021-36... / 10						
Size	6	7	8	10	12	14	16
Wire Ø	0.64	0.60	0.53	0.48	0.39	0.37	0.34
Pcs/Bag	25	25	25	25	25	25	25

NEW 623XK

BN Black Nickel Forged MicroBarb

This is a medium wire, long shanked hook which can face thousands of fishing conditions with great success. The black nickel finish is not only a matter of fashion or a nice cosmetic, but provides protection from abrasion and salt, specially on the weakest area, which is the point's end. This means that the hook can last longer, specially in tough conditions like saltwater fishing. The ankle has been designed to suit trout fishing, because soft worms need to be kept in place, otherwise they tend to slide down the gape, actually affecting the rotation of hookbait, which is vital to catch many fish.



4...040 5...050 6...060 8...080 10...100 12...120 14...140 16...160

Code	021-32... / 10						
Size	4	5	6	8	10	12	14
Wire Ø	0.71	0.67	0.64	0.51	0.46	0.41	0.37
Pcs/Bag	25	25	25	25	25	25	25



Goran "Gica" Radovic during his fantastic performance at 2014 World Championship.

NEW 710XB

BR **Bronzed** **Forged** **Bent**

A great hook to be used when the stress is high, but some finesse is needed at the same time. It's the case of big chub fishing with the bolognese rod and casters as hookbait. The presentation must be spot on, but the fish requires strength to hold and drive it to the landing net. It's also the case of matches involving feeder fishing, specially when bream are the target species: some lightness in the approach pays dividends, but any bonus fish must absolutely reach the keepnet. The most innovative area of this hook is the point, as it's fine on top, then it quickly gets thick and ends with a relatively small barb. Easy penetration as soon as the fish picks up the bait, then safe hold. Definitely worth a try.



Code	021-70... / 10						
Size	8	10	12	14	16	18	20
Wire Ø	0.53	0.48	0.43	0.41	0.38	0.36	0.34
Pcs/Bag	25	25	25	25	25	25	25

8...040 10...060 12...080 14...100 16...120 18...180 20...200

NEW 666XK

BN **Black Nickel** **Forged** **Bent** **Barbless**

In most rivers holding big fish and nearly all commercial lakes, the barb is banned to protect fish destined to be released. That's why the new XPS range also include a hook like this, combining high strength with barbless point. The bent gape provides great hooking efficiency, while the in-turned point creates a narrow ankle which is in charge of holding the fish during hard fight. With black nickel finish, the point gets an extra protection against wear, allowing the angler to catch many fish without being forced to replace the hook before the end of the match.



Code	021-54... / 10				
Size	10	12	14	16	18
Wire Ø	0.67	0.60	0.56	0.51	0.48
Pcs/Bag	25	25	25	25	25

10...100 12...120 14...140 16...160 18...180



Mario Barros

NEW 405XN

N **Nickel** **Forged**

A quite powerful hook, useful when the expected catches are potentially big. His shape is well known and widely used in Italy since ever in case of heavy leger fishing for carp, big barbel and tench, as well as at sea side for sea bream and many other strong fighters, which can actually crunch the hook together with the bait! His powerful structure makes it the ideal partner for feeder and method fishing, where it can match strong hooklinks. The commercial angler can get benefits from the smaller sizes, which also display adequate strength.



Code	021-72... / 10							
Size	4	6	8	10	12	14	16	18
Wire Ø	0.71	0.64	0.57	0.51	0.43	0.41	0.33	0.33
Pcs/Bag	25	25	25	25	25	25	25	25

4...040 6...060 8...080 10...100 12...120 14...140 16...160 18...180

SYMBOLS 1 Hook Size ...020 Product Code



The correct presentation of a living crab on three XPS 735XN hooks, simply the best in the sea bream fishing. In spite of the rig, the crab is free to walk on the sea bottom, attracting the attention of the fish. The hook's size doesn't matter so much, because fish teeth actually crunch the crab's shell, enabling the points to fit, but it's their strength which counts the most. With their special carbon steel and forged bend, 735XN hooks are actually too strong even for such a powerful fish!

NEW 735XN

N Nickel **F** Forged

Specially dedicated to sea fishing, this hook is tremendously reliable and efficient. For such reason it's the main choice of boat anglers in the Mediterranean sea, who can catch big fish with paste bait or even tough shells. Compared to shank's length, the point is quite long, as it goes beyond 50% of total hook's length. This specification grants a firm hold in any condition, and, combined with beak profile plus in-turning design, makes a fantastic combination of power and safety.

Code	021-50... / 10					
Size	2	4	5	6	8	10
Wire Ø	0.98	0.86	0.81	0.71	0.64	0.60
Pcs/Bag	25	25	25	25	25	25

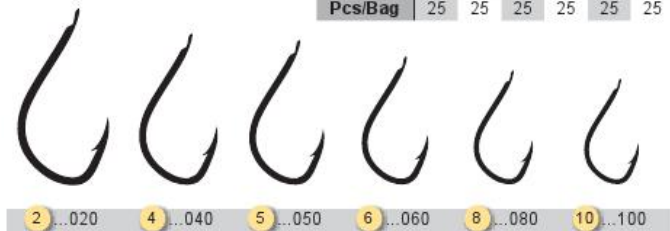

NEW 261XK

BN Black Nickel **F** Forged

All those anglers who love hard fighting fish know that often they live under thick covers or between snags. In such environments, the fish must be quickly pulled away from the dangerous features, but, to do so, the hook must bear tremendous pressure. This 261XK is the solution developed by Trabucco team, with a super strong structure and an in-turned point which never gives up. Black nickel finish provides extra protection against abrasion and saltwater, actually expanding hook's life.



Code	021-48... / 10					
Size	2	4	5	6	8	10
Wire Ø	0.98	0.86	0.81	0.71	0.64	0.60
Pcs/Bag	25	25	25	25	25	25

NEW 620XK

BN Black Nickel **F** Forged **B** Bent **3D-CUT**

A stunning concentrate of strength and efficiency, with the fantastic 3D point, the super strong structure and the bend which pushes the hooking power beyond the imagination. The special point is almost flat on the inside, while has a rib running along the outside. Such feature strengthens the whole point, without affecting the penetration at all, easing it through the toughest mouths. The end result is a fantastic hook mainly for sea fishing, but also for commercial fishing in the smaller sizes. Black nickel finish offers protection against wear and salt.



Code	021-52... / 10									
Size	2	4	5	6	8	10	12	14	16	18
Wire Ø	0.98	0.86	0.81	0.76	0.71	0.67	0.64	0.57	0.51	0.46
Pcs/Bag	25	25	25	25	25	25	25	25	25	25

XPS SPECIAL SERIES

The five series shown in the 2014 catalogue are confirmed also for 2015 season, because the success they gained amongst top match anglers has really been wide and enthusiastic. Three of these series feature the PTFE finish, a Japanese technology which pushes hook's efficiency to an higher level.



TEF-TEK

PTFE is a well known polymer which is frictionless and highly resistant to wear. Once applied to XPS hooks, it dramatically improves their performances.

- Camouflage: the hook's colour is faded, thus less obtrusive towards the environment in which fish live and feed. The absence of any reflection is worth specially when fishing shallow or gin clear waters.
- Protection: the PTFE treatment protects the point from abrasion caused by multiple catches and inevitable hit to the bottom or snags.
- Efficiency: thanks to the extremely smooth surface, the knot's coils get very much tight and neat. Consequently, the knot's volume is reduced with the resulting improved presentation.
- Bait hooking: The hook's point gets easily through living bait's skin, without causing any tear even in case of thick wire, which is the case of most feeder patterns.



TFK 10



Brand new hook coated with the innovative Tef-Tek process and chemically sharpened needle point. Featuring a wide gap, medium wire shank and extremely strong. With micro barb and slightly reversed point. Ideal for big-sized fish.



12...012 14...014 16...016 18...018

Code	021-01-... / 10			
Size	12	14	16	18
Pcs/Bag	10	10	10	10

TFK 20

Featuring the Tef-Tek process, to increase the the hook's penetration and improve presentation and built with high carbon steel percentage. TFK20 is extremely light and strong. Very wide and slightly angular gap. Perfect hooks for carp, crucian carp, chub and big bream.



12...012 14...014 16...016 18...018 20...020

Code	021-02-... / 10				
Size	12	14	16	18	20
Pcs/Bag	10	10	10	10	10

TFK 40



The most versatile hooks in match fishing, featuring a round bend, thin wire, high penetration micro barb, chemically sharpened needle point. The Tef-Tek process ensures also the point will last longer. Suitable for carp, crucian, bream and chub, baiting maggots, worm, bloodworm and caster.



14...014 16...016 18...018 20...020

Code	021-04-... / 10			
Size	14	16	18	20
Pcs/Bag	10	10	10	10

XP 01

Bronzed hook with round curve, medium sized straight shank provided with micro barb. Chemically sharpened point and lazer finished. Extra light weight. Ideal for difficult fishes like chubs, crucians, bream and gardons. The ultra-thin shank is ideal for very small and delicate baits.



14...014 16...016 18...018 20...020 22...022 24...024

Code	021-10-... / 10					
Size	14	16	18	20	22	24
Pcs/Bag	10	10	10	10	10	10

XP 02



Micro barbed, with extra-thin shank and large curve. Very strong hook, recommended for carps, crucians, and big breams. Perfect for jokers and maggots or pinkies. The particular design of the curve avoid unhooking while landing the fish.



16...016 18...018 20...020 22...022 24...024

Code	021-20-... / 10				
Size	16	18	20	22	24
Pcs/Bag	10	10	10	10	10

PROSWORD

810



Designed for bleak and other small fish, the long and thin shank helps the unhooking process. Particularly suited to bait small maggots or bloodworms and jokers.



18...018 20...020 22...022 24...024 26...026

Code	020-81-... / 10				
Size	18	20	22	24	26
Pcs/Bag	20	20	20	20	20

2310



Long and thin shank hook, with a narrow gap suitable for fishing all kind of fish, but particularly suited to fishing with bloodworms for skimmers and roach.



16...016 18...018 20...020 22...022 24...024

Code	022-31-... / 10				
Size	16	18	20	22	24
Pcs/Bag	20	20	20	20	20

SYMBOLS

1 Hook Size ...020 Product Code

LUCIFER

Series of hooks that have been developed to face the demand of those commercial fisheries fans. It has been developed in cooperation with the best British match aces, where this particular fishing competitions have become during these last years a true mania. The range of patterns is quite large, offering 8 different solutions. They are produced with the best stainless steel combined with high carbon percentage, that preserves the point sharpened for longer time.



LUCIFER 222

BN Black Nickel Regular Barbless



16...016 18...018 20...020

Code	020-22...
Size	16 18 20
Pcs/Bag	10 10 10

LUCIFER 333

BN Black Nickel Regular Barbless



8...008 10...010 12...012 14...014 16...016 18...018

Code	020-33...
Size	08 10 12 14 16 18
Pcs/Bag	10 10 10 10 10 10

LUCIFER 444

BR Bronzed Regular Barbless



12...012 14...014 16...016 18...018 20...020

Code	020-44...
Size	12 14 16 18 20
Pcs/Bag	10 10 10 10 10

LUCIFER 555

BR Bronzed Regular Barbless



12...012 14...014 16...016 18...018 20...020

Code	020-55...
Size	12 14 16 18 20
Pcs/Bag	10 10 10 10 10

2510

BR Bronzed Regular Barbless

Bronzed hook, with very special bend, high point chemically sharpened, barbless. Extremely strong, suitable for commercial fisheries.

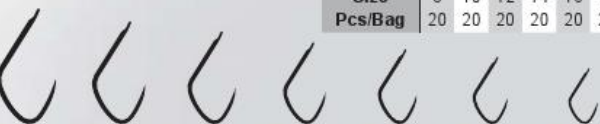

8...008 10...010 12...012 14...014 16...016 18...018 20...020

Code	022-51...
Size	8 10 12 14 16 18 20
Pcs/Bag	20 20 20 20 20 20 20

LUCIFER 666

BR Bronzed Regular Barbless



10...010 12...012 14...014 16...016 18...018

Code	020-66...
Size	10 12 14 16 18
Pcs/Bag	10 10 10 10 10

LUCIFER 777

BR Bronzed Forged Barbless



16...016 18...018 20...020

Code	020-77...
Size	16 18 20
Pcs/Bag	10 10 10

LUCIFER 888

BR Bronzed Forged Barbless



10...010 12...012 14...014 16...016

Code	020-88...
Size	10 12 14 16
Pcs/Bag	10 10 10 10

PROSWORD

2710

BR Bronzed Regular Barbless

Bronzed hook, barbless, large bend and high penetration chemically sharpened point. Very strong, it is suitable for carp fishing in commercial fisheries.



8...008 10...010 12...012 14...014 16...016 18...018

Code	022-71...
Size	8 10 12 14 16 18
Pcs/Bag	20 20 20 20 20 20



PRO SWORD TO NYLON

The Pro-Sword hooks to nylon are produced with handcraft work, in order to give the best performance.

They are tied with a Japanese monofilament of very high quality, supple and with an excellent knot strength. The hooks are tied in order stay and show the bait always in the right position, perpendicularly on the ideal fishing line.

The quality controls are very strict and accurate, because these hooks are made for competitions, and so they must offer a constant quality during the whole production.

The special packaging makes extremely easy and fast to take out the hooks, and avoid the creation of sharp corners on the line. The selection of the patterns we have used is the result of a 20 years long legendary fishing career, all over the rivers of Europe.

Every bag contains 10 hooks to nylon.



PRO SWORD 100

Code	Size	Diameter	Length
210-08-016	08	0.160	70
210-08-018	08	0.180	70
210-10-014	10	0.140	70
210-10-016	10	0.160	70
210-12-012	12	0.120	70
210-14-012	14	0.120	70
210-14-014	14	0.140	70
210-16-010	16	0.100	70
210-16-012	16	0.120	70
210-18-010	18	0.100	70
210-18-012	18	0.120	70
210-20-010	20	0.100	70



PRO SWORD 400

Code	Size	Diameter	Length
240-10-014	10	0.140	70
240-10-016	10	0.160	70
240-12-012	12	0.120	70
240-12-014	12	0.140	70
240-14-010	14	0.100	70
240-14-012	14	0.120	70
240-16-010	16	0.100	70
240-16-012	16	0.120	70
240-18-008	18	0.080	70
240-18-010	18	0.100	70
240-18-012	18	0.120	70



PRO SWORD 200

Code	Size	Diameter	Length
220-06-016	06	0.160	70
220-06-018	06	0.180	70
220-08-014	08	0.140	70
220-08-018	08	0.180	70
220-10-014	10	0.140	70
220-10-016	10	0.160	70
220-12-014	12	0.140	70
220-12-016	12	0.160	70
220-14-012	14	0.120	70



PRO SWORD 410

Code	Size	Diameter	Length
241-14-010	14	0.100	70
241-14-012	14	0.120	70
241-16-010	16	0.100	70
241-16-012	16	0.120	70
241-18-008	18	0.080	70
241-18-010	18	0.100	70
241-18-012	18	0.120	70



PRO SWORD 210

Code	Size	Diameter	Length
225-16-010	16	0.100	70
225-18-010	18	0.100	70
225-18-012	18	0.120	70
225-20-008	20	0.080	70
225-20-010	20	0.100	70
225-22-008	22	0.080	70



PRO SWORD 2310

Code	Size	Diameter	Length
290-16-010	16	0.100	70
290-16-012	16	0.120	70
290-18-010	18	0.100	70
290-20-008	20	0.080	70
290-22-008	22	0.080	70
290-22-010	22	0.100	70
290-24-010	24	0.100	70

SHINKEN



SHINKEN MEBARU 3D-CUT 50674

Spade hook with medium curve shank. Designed to be used with fragile baits, including live prawn.

N Nickel **F** Forged **3D-CUT**

Code	201-70-.../10
Size	2 4 6 8
Pcs/Bag	10 10 10 10

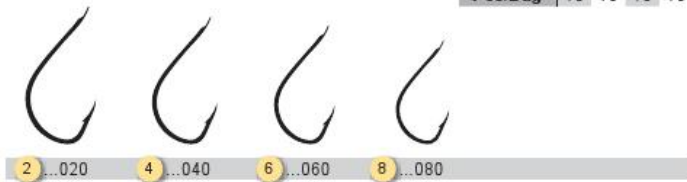

SHINKEN PINT 53117

Special hook, specifically designed for Surf Casting. Medium shank and aligned eye, light weight and high penetration needle point. Light but strong.

BN Black Nickel **R** Ringed

M MicroBarb **T** Twisted

Code	201-65-.../10
Size	2 4 6 8 10 12
Pcs/Bag	10 10 10 10 10 10

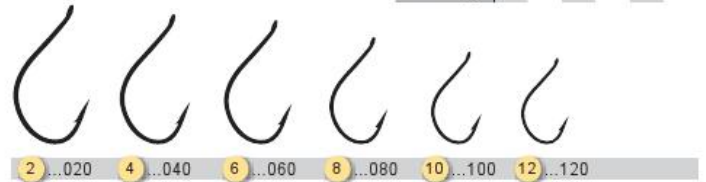

SHINKEN RYUSEN 50840

Specific hook for fishing with worms, light weight and thin shank equipped with two micro barbs and fast penetrating straight needle point.

N Nickel **F** Forged

M MicroBarb

Code	201-45-.../10
Size	1 2 4 6 8 10
Pcs/Bag	10 10 10 10 10 10

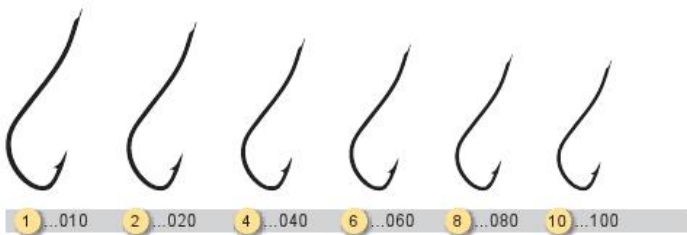

SHINKEN BIG SURF 50538

Spade carbon steel hook designed for surf casting. It is perfect for big baits.

BN Black Nickel **F** Forged **M** MicroBarb

T Twisted

Code	202-10-.../10
Size	1/0 1 2 4 6
Pcs/Bag	10 11 12 13 15

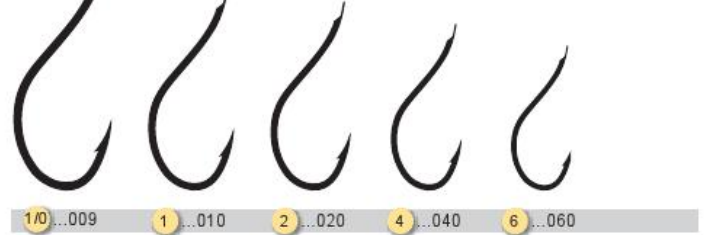

SHINKEN C5 53265

Super resistant medium wire hooks for heavy fishing and carp fishing. Short shank, beaked point. Barbed.

BN Black Nickel **F** Forged **R** Ringed

Code	201-20-.../10
Size	1 2 4 6 8 10 12 14 16
Pcs/Bag	10 10 10 10 10 10 10 10 10

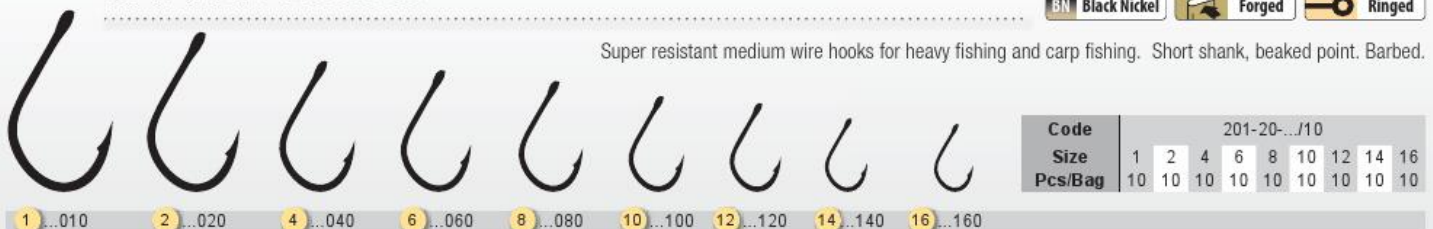



SHINKEN ISEAMA 50188

BN Black Nickel Forged MicroBarb Ringed

Super strong micro-barbed hooks. A true allrounder can be used both for sea fishing as well as freshwater, the smaller sizes can be well employed also for feeder fishing. Available in a wide range of sizes.



Code	201-25-.../10								
Size	1	2	4	6	8	10	12	14	16
Pcs/Bag	10	10	10	10	10	10	10	10	10

1...010 2...020 4...040 6...060 8...080 10...100 12...120 14...140 16...160

SHINKEN MARU-KAIZU 50611

Light weight but really strong hook with a super high penetration point. It is the perfect hook for sea bream fishing (gilt-head).

N Nickel MicroBarb

Code	201-50-.../10				
Size	1	2	4	6	8
Pcs/Bag	10	10	10	10	10



1...010 2...020 4...040 6...060 8...080

SHINKEN CHINU 3D-CUT 50339

Strong medium shank hook, light weight and equipped with quick, deep penetrating 3D-Cut Point. The ideal hook for all bottom fishing techniques.

BN Black Nickel Forged 3D-CUT Twisted

Code	201-35-.../10					
Size	1	2	4	6	8	10
Pcs/Bag	13	13	14	14	14	14



1...010 2...020 4...040 6...060 8...080 10...100

SHINKEN MADAI 3D-CUT 50610

Very strong spade hook designed to be used for Madai fishing. It features the right shape to bait medium/big shrimps and similar natural baits. High penetration 3D-Cut Point.

BN Black Nickel Forged 3D-CUT

Code	201-60-.../10					
Size	3/0	2/0	1/0	1	2	4
Pcs/Bag	8	8	8	10	10	10

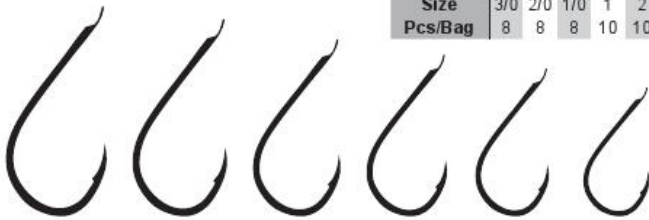

3/0...007 2/0...008 1/0...009 1...010 2...020 4...040

SHINKEN SUPER CHINU 3D-CUT 51481

Stronger version of the Cut Chinu, it features the same super sharped 3D-Cut Point. Designed for heavy duty fishing that require reliable hooks.

BN Black Nickel Forged Twisted 3D-CUT

Code	201-40-.../10						
Size	2/0	1/0	1	2	4	6	8
Pcs/Bag	8	10	10	10	10	10	10



2/0...008 1/0...009 1...010 2...020 4...040 6...060 8...080

SHINKEN CHINU EYE 50335

BN Black Nickel Forged MicroBarb Twisted Ringed

Strong medium shank hook, light weight and equipped with quick, deep penetrating. The perfect choice for heavy duty fishing in salt and fresh water.



Code	201-30-.../10							
Size	3/0	2/0	1/0	1	2	4	6	8
Pcs/Bag	10	10	10	10	10	10	10	10

3/0...007 2/0...008 1/0...009 1...010 2...020 4...040 6...060 8...080

SHINKEN GURE 3D-CUT 50330

N Nickel Forged 3D-CUT

Super strong spade hook for heavy duty fishing in salt water. The 3D-Cut Point grants a perfect hookset.



Code	201-55-.../10						
Size	1/0	1	2	4	6	8	10
Pcs/Bag	10	10	10	10	10	8	8

1/0...009 1...010 2...020 4...040 6...060 8...080 10...100

SYMBOLS

1 Hook Size ...020 Product Code

SHINKEN AKI 3D-CUT 5170

BN Black Nickel Forged Ringed 3D-CUT

Aki hooks are super strong thanks to the forged shank and features a deep penetration thanks to the 3D-Cut Point. Ideal for all challenging salt water fishing techniques. Colour: Black Chrome.

Code	202-05-.../10							
Size	8/0	7/0	6/0	5/0	4/0	3/0	2/0	1/0
Pcs/Bag	3	3	5	5	5	7	7	7

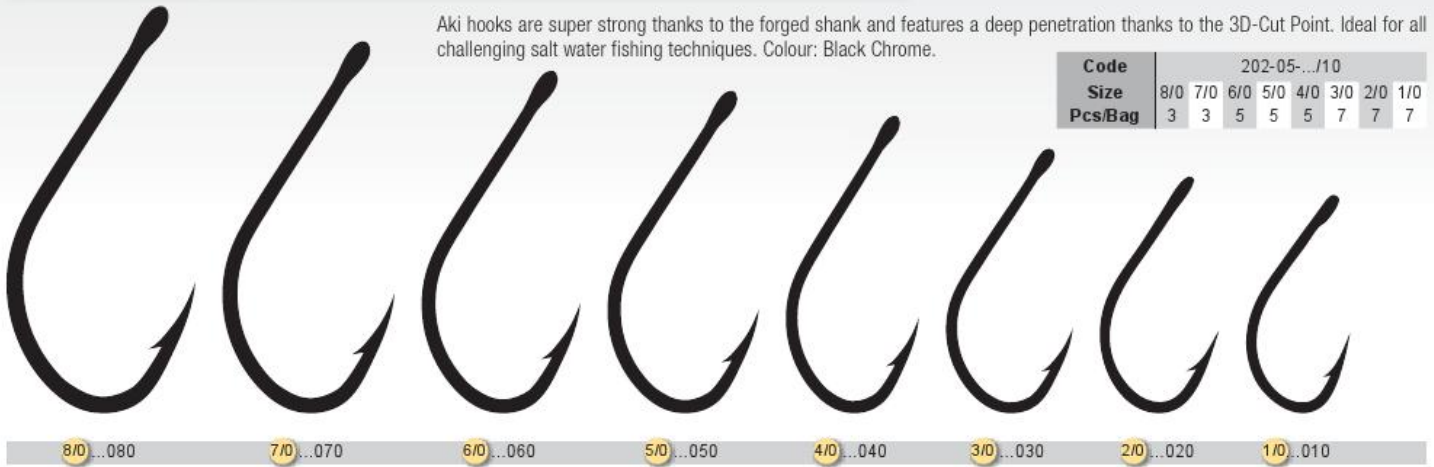

SHINKEN PAYAO 50825

N Nickel Forged MicroBarb Twisted Ringed

Tin plated stainless steel hook. Extremely strong and reliable. Designed for live bait trolling and drifting.

Code	201-75-.../10					
Size	6/0	4/0	2/0	1/0	1	2
Pcs/Bag	7	7	7	5	5	5

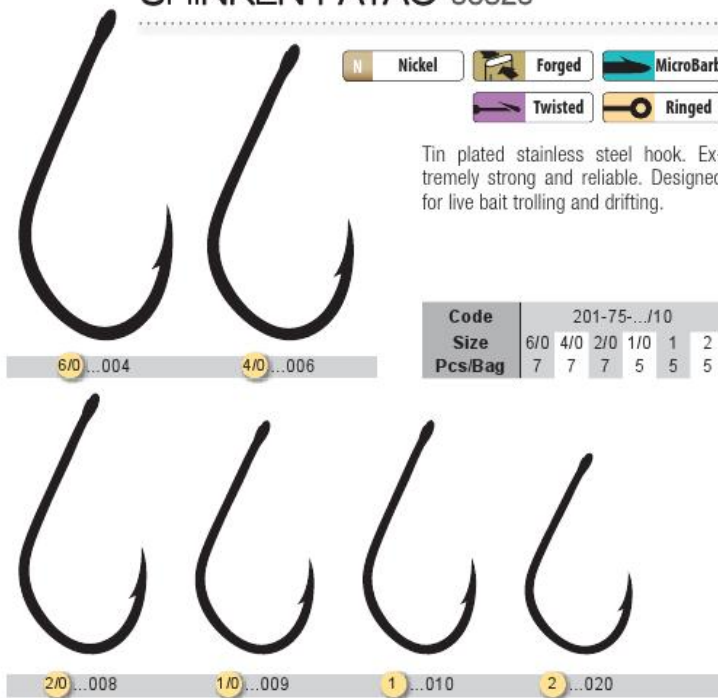

SHINKEN PAYAO II 50835

Tin plated stainless steel hook double reinforced toward standard Payao. Extremely strong and reliable. Designed for extreme live bait trolling and drifting. Ringed, colour: Tin.

TN Tin Forged MicroBarb Twisted Ringed

Code	202-15-.../10			
Size	8/0	7/0	5/0	3/0
Pcs/Bag	3	3	4	4

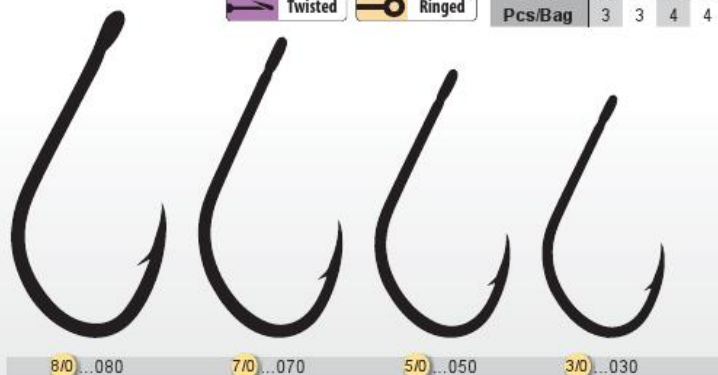

Saverio Rosa



SHINKEN SW 3D-CUT 5111

BN Black Nickel Forged Twisted Ringed 3D-CUT

One of the most used hooks ever. According to the size you can use these hooks for a variety of techniques, from salmon and steel-head fishing to offshore trolling. Super reliable thanks to the 3D-Cut Point.

Code	201-80-.../10											
Size	8/0	6/0	4/0	3/0	2/0	1/0	1	2	4	6	8	
Pcs/Bag	3	4	6	7	8	8	9	10	10	11	12	

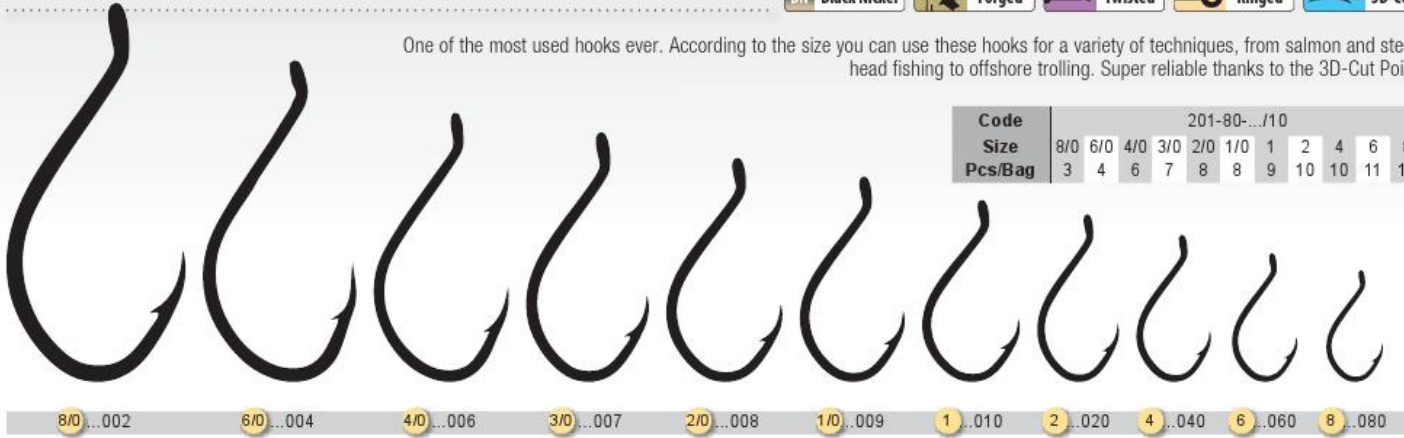

SHINKEN SW/SE 3D-CUT 5180

BN Black Nickel Forged Twisted Ringed 3D-CUT

The SSW's Straight Eye delivers a more efficient in-line hook set. SSW features include a 3D-Cut Point for superior penetration, offset point for "sticking power".

Code	201-85-.../10							
Size	6/0	4/0	3/0	2/0	1/0	1	2	4
Pcs/Bag	4	6	6	6	6	6	8	10



SHINKEN MUTSU CIRCLE 5163

BN Black Nickel Forged MicroBarb Twisted Ringed

Hook designed for challenging fishing techniques. It is able to self position in the correct way inside the fish mouth and always allows catch and release action.

Code	201-95-.../10					
Size	6/0	5/0	4/0	3/0	2/0	1/0
Pcs/Bag	3	4	5	5	5	5

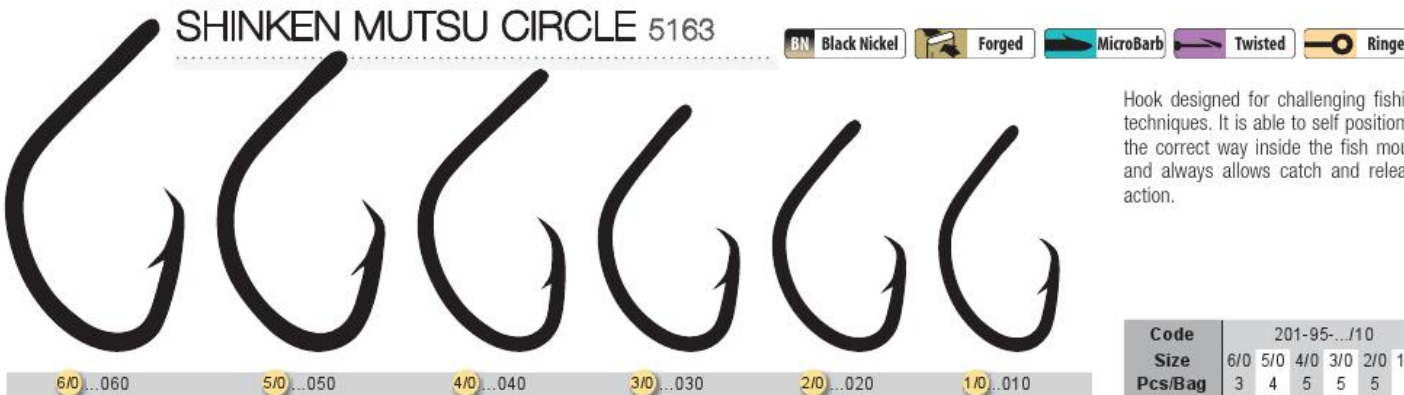

SHINKEN HD LIVE BAIT 3D-CUT 5105

BN Black Nickel Forged Ringed 3D-CUT

HD Live Bait hooks are designed for rigging large baits for heavy-duty fishing, such as trolling, big game and deep sea fishing. 3D-Cut Point.

Code	201-90-.../10						
Size	10/0	9/0	8/0	7/0	6/0	5/0	4/0
Pcs/Bag	2	2	2	3	3	4	4

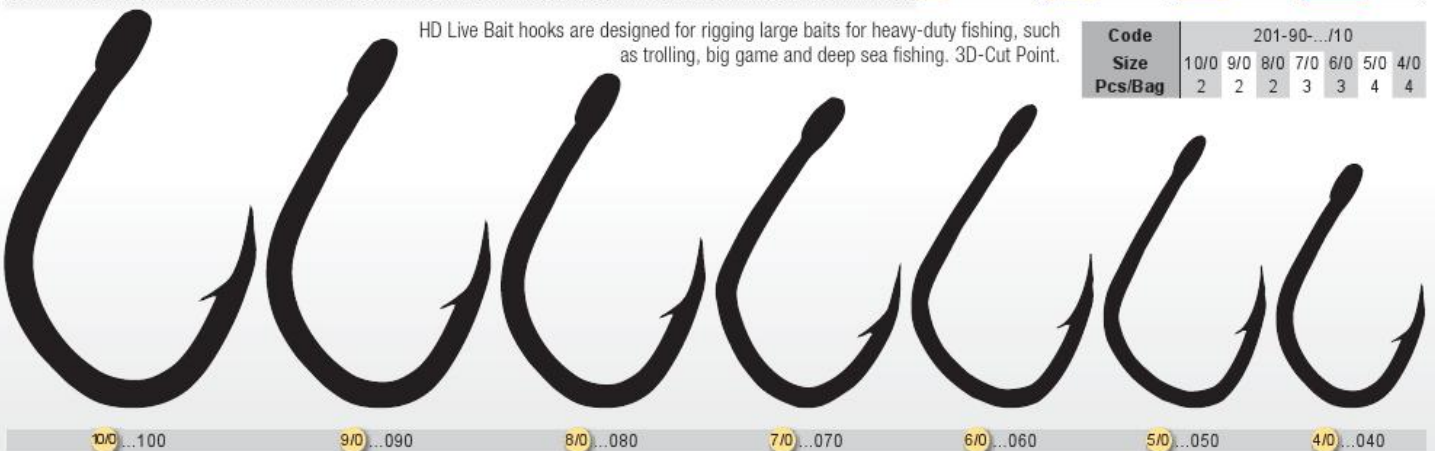



SHINKEN S-75M 51642

Specific series of barbed hooks to be used to replace wobblers trebles. Made with high-carbon steel.

BN Black Nickel Ringed
MicroBarb

Code	201-00-... /10			
Size	1	2	4	6
Pcs/Bag	10	10	10	10

1...010 2...020 4...040 6...060

SHINKEN S-55BL 51611

Specific series of barbless hooks to be used to replace wobblers trebles. Made with high-carbon steel.

BN Black Nickel Ringed
Barbless

Code	201-05-... /10			
Size	4	6	8	10
Pcs/Bag	10	10	10	10

4...040 6...060 8...080 10...100



SHINKEN S-35BL 51607

Special super fine shank series of barbless hooks to be used to replace spoons and spinners trebles. Made with high-carbon steel.

BN Black Nickel Ringed Barbless

Code	201-10-... /10		
Size	4	6	8
Pcs/Bag	10	10	10

4...040 6...060 8...080

SHINKEN S-31 51650

Specific series of barbed hooks to be used to replace spoons and spinners trebles. Made with high-carbon steel.

BN Black Nickel Ringed
MicroBarb

Code	201-15-... /10			
Size	2	4	6	8
Pcs/Bag	10	10	10	10

2...020 4...040 6...060 8...080



SHINKEN T-36 5636

BN Black Nickel Forged Ringed MicroBarb Strong

ShinkenT-36 trebles has a Black Chrome finishing and so it can be used both in fresh and salt water. Round bend and needle points hooks for wide-gap hooking efficiency.

Code	205-00-.../10									
Size	2	4	6	8	10	12	14	16	18	20
Pcs/Bag	6	6	6	6	6	6	6	6	6	6

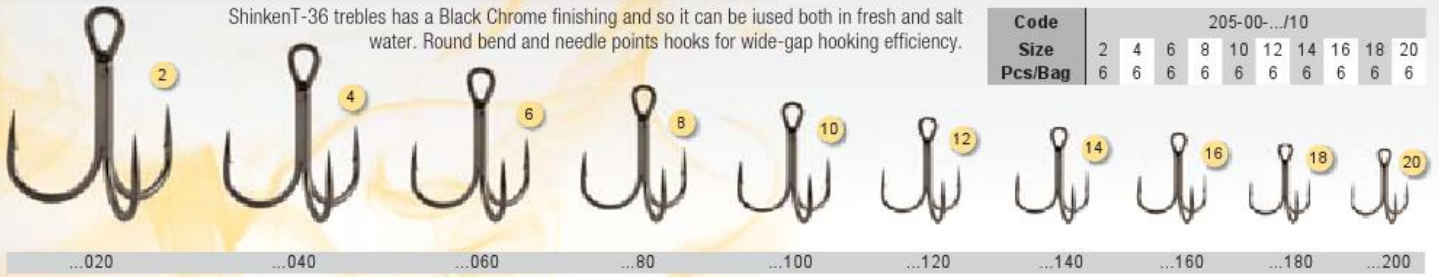

SHINKEN T-41 5641

TN Tin Forged Ringed 3D-CUT 2X Strong

The 2X strong ShinkenT-41 trebles are perfect for replacing old crankbait and plug hooks, both for fresh and salt water fishing. Slightly curved 3D-Cut Point allows for quick, deep penetration. Tinned finish.

Code	205-05-.../10					
Size	2/0	1/0	1	2	4	6
Pcs/Bag	3	4	4	6	6	6

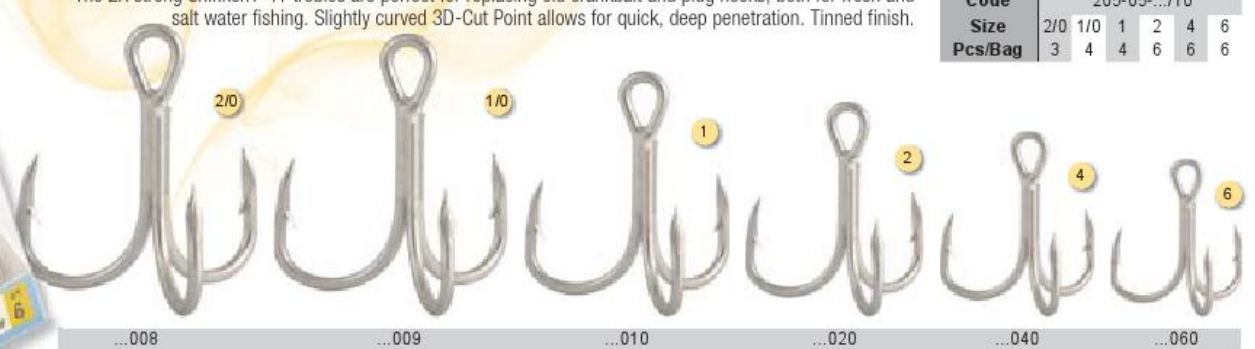

SHINKEN T-46 5646

Forged Ringed MicroBarb 2X Strong

ShinkenT-46 trebles are extremely strong, reliable and light weight. They are the best you can get for your salt water lures. The straight needle point grants super deep and fast hook set. Available in Tin or Black Chrome finish.

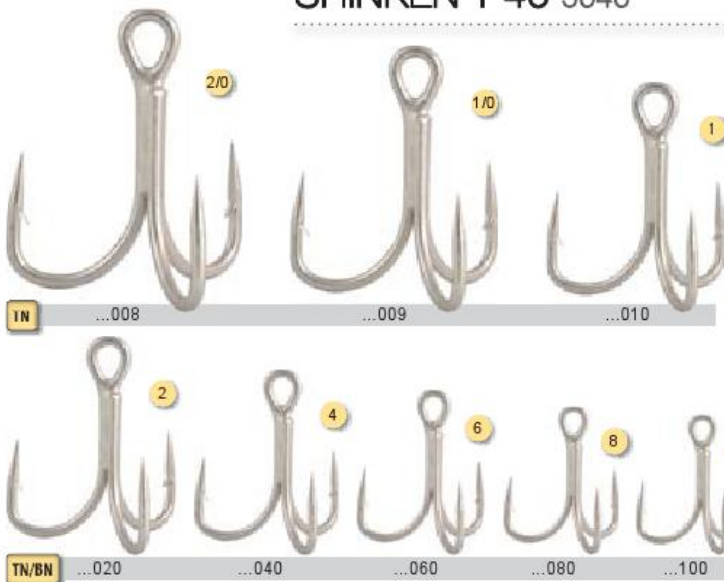

Code	205-10-.../10					Code	205-15-.../10							
Size	2	4	6	8	10	Size	2/0	1/0	1	2	4	6	8	10
Pcs/Bag	6	6	6	6	6	Pcs/Bag	4	4	4	6	6	6	6	6

SHINKEN T-56

TN Tin Forged Ringed MicroBarb 3X Strong

The ShinkenT- 56 trebles are 3X-Strong with a corrosion-resistant black chrome finish and are perfect replacement hooks for improving hooking power of your lures. Feature a short shank, forged bends, and three straight needle points.

Code	205-20-.../10					
Size	3/0	2/0	1/0	1	2	4
Pcs/Bag	3	3	3	4	5	5



SYMBOLS 1 Hook Size ...020 Product Code

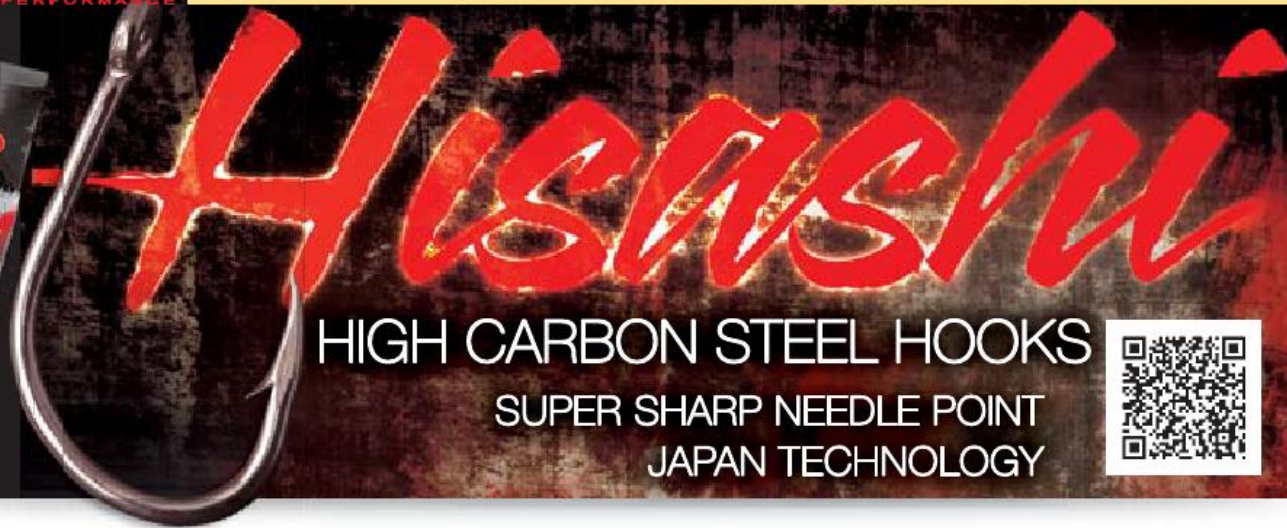

HIGH CARBON STEEL HOOKS
SUPER SHARP NEEDLE POINT
JAPAN TECHNOLOGY



NEW P1039 MATCH

A classic hook for modern feeder fishing, offering a nice balance between strength and lightness. The out-turned eye helps knotless knot to be used to form hair rigs and present sweetcorn, pellets and mini boilies. The fantastic beak point is designed with a fine top edge in order to provide the first prick when the fish bolts and is strong enough to hold firmly during the fight with big fish.

BR Bronzed

Ringed

Code	024-22... / 10			
Size	10	12	14	16
Pcs/Bag	15	15	15	15

NEW P1003 POWER

Nowadays, the gap between heavy feeder and carp fishing is narrow as never before, specially thanks to method fishing and thanks to the wide offer of dedicated baits such as pellets and mini boilies. This means that hooks are subject to higher pressure than in the past, so Trabucco team decided to also develop special hooks like this. Every detail has been carefully studied: from wire thickness to turned eye, from super sharp beak point to nice bronzed finish, a must for this sort of hooks.

BR Bronzed

Forged

Ringed

Code	024-20... / 10				
Size	8	10	12	14	16
Pcs/Bag	15	15	15	15	15



10...100 12...120 14...140 16...160



8...080 10...100 12...120 14...140 16...160

11007 BEACK

Semi-forged, special anti corrosion black nickel finish. High self-hooking ratio, this hook is perfect for deep sea fishing using natural baits. Ringed.



1/0...009 1...010 2...020 4...040 6...060 8...080

BN Black Nickel

Forged

Ringed

Code	024-00...					
Size	1/0	1	2	4	6	8
Pcs/Bag	13	15	15	15	15	15

10003 TANAGO

Semi-forged hook, ringed, with heavy duty point. The smaller sizes can be used also for big predator in fresh water, perfect for deep sea fishing.

BN Black Nickel

Forged

Ringed

Code	024-10...				
Size	2	4	6	8	10
Pcs/Bag	15	15	15	15	15



2...020 4...040 6...060 8...080 10...100

1042 OCTOPLUS

Ringed hook with forged and semi-banded shank. The long and sharp point can penetrate even the hardest sea predator mouth. Can be used also to rig big live bait in fresh water.

BN Black Nickel

Forged

Ringed

Code	024-12...				
Size	2	4	6	8	10
Pcs/Bag	15	15	15	15	15



2...020 4...040 6...060 8...080 10...100



NEW F31-SURF

Specially developed for light surf casting, it's the ideal weapon to search fish when they are particularly shy, as it can present worms in the most natural way. The beak point grants penetration and holding properties, while the long shank offers room for long worms, easing both baiting and disgorging operations. The straight eye can be tied in several ways, saving most of the line's breaking strength.

Black Nickel
Forged
Ringed

Code		024-18... / 10					
Size	Pcs/Bag	04	06	08	10	12	14
Size	Pcs/Bag	15	15	15	15	15	15

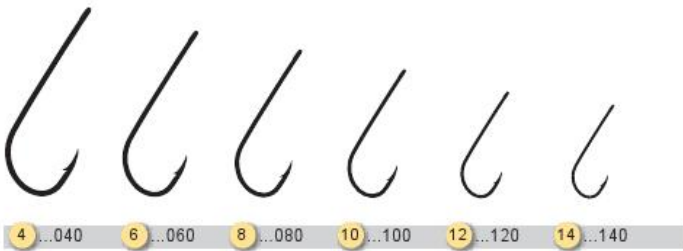

11014 BATHOLDER

Ringed hook with semi-forged shank. Two micro barb help to fit the bait on the hook, very helpful when using long and delicate worms or particularly soft baits. Can be used in many different situation, both from the shore or from the boat, black nickel finish.

Black Nickel
Forged
Ringed

Code		024-02...					
Size	Pcs/Bag	1/0	1	2	4	6	8
Size	Pcs/Bag	13	15	15	15	15	15

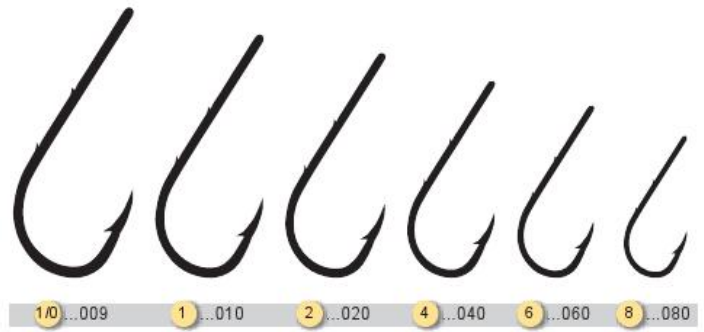

3282 ABERDEEN

Ringed hook, black nickel finish. Made using high carbon steel and extreme sharp point. Can be used for surf casting or boat fishing.

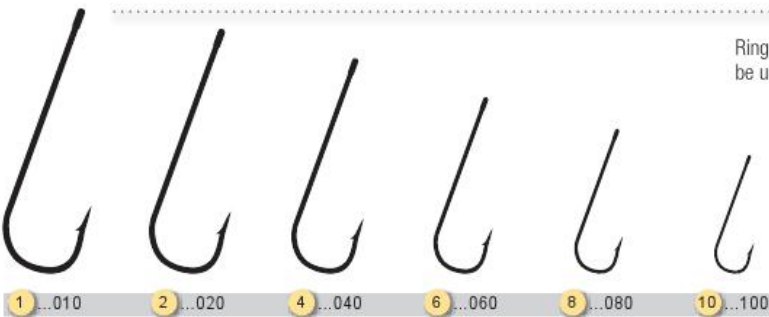

Black Nickel
Forged
Ringed

Code		024-14...					
Size	Pcs/Bag	1	2	4	6	8	10
Size	Pcs/Bag	15	15	15	15	15	15

10026 CHINU

Black Nickel
Forged
Ringed

Ringed hook, semi-forged shank and blade point. Thanks to the wide range of sizes available can be used in many different fishing style, from drifting to deep sea fishing. Black nickel finish.



Code		024-04...											
Size	Pcs/Bag	5/0	4/0	3/0	1/0	1	2	4	6	8	10	12	14
Size	Pcs/Bag	6	7	9	13	15	15	15	15	15	15	15	15



SYMBOLS 1 Hook Size ...020 Product Code

11028 LIVE BAIT

This hook as been designed to fish mainly with live bait for Dentex and other big sea predator. The point is extremely sharp, forged shanks, black nickel finish. Ringed.



Code	024-08...					
Size	10/0	8/0	6/0	4/0	2/0	1/0
Pcs/Bag	3	5	7	9	9	9



10/0...000	8/0...002	6/0...004	4/0...006	2/0...008	1/0...009
------------	-----------	-----------	-----------	-----------	-----------

11011 O'SHAUGHNESSY

Heavy duty hook, semi-forged shank and with black nickel finish. This shape is perfect to be used when rigging anchovy and squid. Ringed.



Code	024-06...													
Size	6/0	4/0	2/0	1/0	1	2	4	6	8	10	12	14		
Pcs/Bag	5	8	11	13	13	15	15	15	15	15	15	15	15	15



6/0...004	4/0...006	2/0...008	1/0...009	1...010	2...020	4...040	6...060	8...080	10...100	12...120	14...140
-----------	-----------	-----------	-----------	---------	---------	---------	---------	---------	----------	----------	----------

11026 CAT FISH

This shape is absolutely the most popular and effective to fish for european catfish with live baits. Big sized barb allows to fight the fish for long time without any risk. The wide shape is perfect to rig big live-baits. Black Nickel finish.



Code	024-16...			
Size	10/0	8/0	6/0	4/0
Pcs/Bag	5	5	5	5

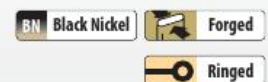

10/0...000	8/0...002	6/0...004	4/0...006
------------	-----------	-----------	-----------

AKURA

CARBON HOOKS



Maurizio Fedeli



AKURA 6315

N Nickel **R** Regular **MB** MicroBarb

Nickel plated hook, round and thin wire, round bend, micro barb and chemical sharpened needle point. Excellent for inland water game fishing. Recommended baits: silkworms, worms, corn, casters and ver de vase.

Code	025-20-...						
Size	10	12	14	16	18	20	22
Pcs/Bag	15	15	15	15	15	15	15

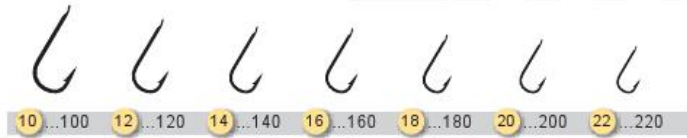

AKURA 6000

BN Black Nickel **R** Regular **MB** MicroBarb

Black nickel plated hook, round and medium-thin wire, long shank, wide bend, micro barb and chemically sharpened needle point. Especially meant for competitions, excellent for bremes, gardons, carps and chubs. Recommended baits: ver de vase, worms, corn, silkworms, casters.

Code	025-25-...					
Size	10	12	14	16	18	20
Pcs/Bag	15	15	15	15	15	15

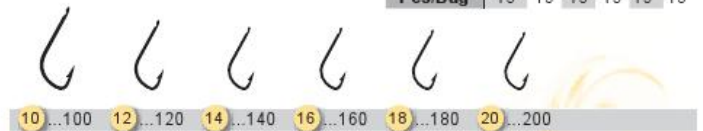

AKURA 3000

BN Black Nickel **F** Forged **MB** MicroBarb

Black nickel plated hook, wide bend, medium shank, high penetration chemically sharpened point and micro barb. Recommended baits: silk worms, corn, ver vase, caster etc.

Code	025-35-...							
Size	04	06	08	10	12	14	16	18
Pcs/Bag	15	15	15	15	15	15	15	15

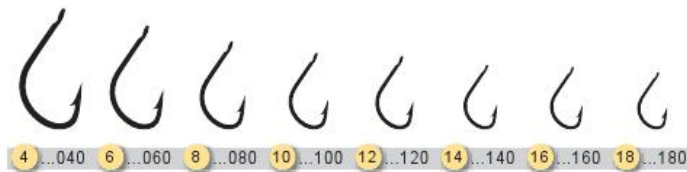

AKURA 3000G

BN Black Nickel **F** Forged **MB** MicroBarb

Golden hook, medium shank, wide bend, high resistance micro barb and chemically sharpened point. For cyprinids in general, and excellent in competitions.

Code	025-30-...					
Size	08	10	12	14	16	18
Pcs/Bag	15	15	15	15	15	15

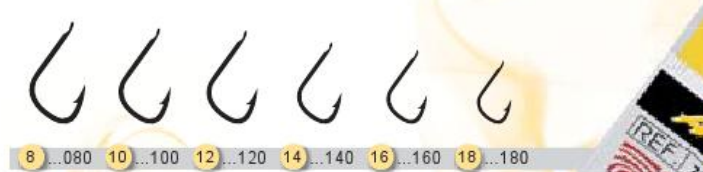

AKURA 7000

N Nickel **R** Regular

Nickel plated hook, medium-short shank, wide bend and chemically sharpened reversed point, medium-thin wire, with anti-disgorging barb. Ideal for inland waters game fishing and at sea.

Code	025-05-...													
Size	2/0	1/0	01	02	04	06	08	10	12	14	16	18	20	
Pcs/Bag	15	15	15	15	15	15	15	15	15	15	15	15	15	

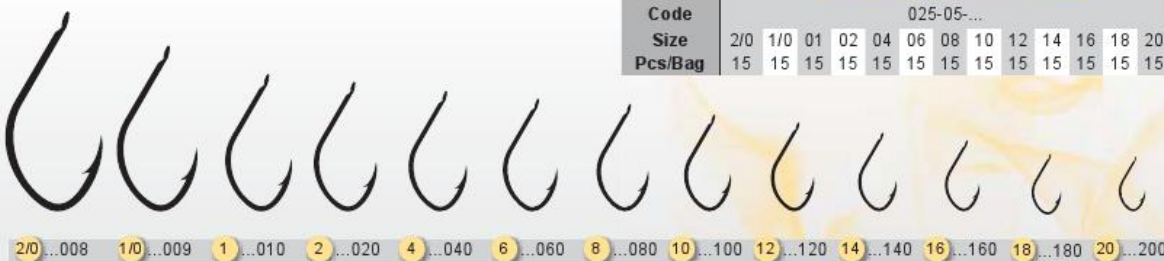

SYMBOLS 1 Hook Size ...020 Product Code

AKURA 200BN

BN Black Nickel **Regular** **MicroBarb**



2...020 3...030 4...040 5...050 6...060 7...070 8...080 10...100

Black nickel plated hook, round wire, long shank, special anti-disgorging bend, chemically sharpened needle point, micro barb. For trout and tough fish fishing.

Code	025-70-...							
Size	02	03	04	05	06	07	08	10
Pcs/Bag	15	15	15	15	15	15	15	15

AKURA 200NY

N Nickel **Regular** **MicroBarb**



2...020 3...030 4...040 5...050 6...060 7...070 8...080 10...100

Nickel-plated hook, round wire, long shank, anti-disgorging special bend, chemically sharpened needle point and high resistance micro barb. Recommended baits: silkworms, salmon eggs, worms.

Code	025-75-...							
Size	02	03	04	05	06	07	08	10
Pcs/Bag	15	15	15	15	15	15	15	15

AKURA 515N

N Nickel **Forged** **MicroBarb**



3/0...007 2/0...008 1/0...009 1...010 2...020 4...040 6...060 8...080 10...100 12...120

Nickel plated long shank hook, medium wire, high resistance barb and high penetration point. Universal purpose. Recommended baits: silkworms, ver de vase, shrimps, mussels, salmon eggs, worms etc.

Code	025-15-...									
Size	3/0	2/0	1/0	01	02	04	06	08	10	12
Pcs/Bag	15	15	15	15	15	15	15	15	15	15

AKURA 220BR

BR Bronzed **Forged** **MicroBarb**



1...010 2...020 3...030 4...040 5...050 6...060

Bronzed series developed for trout fishing. Semi-forged, medium wire long shank and special antidisgorging bend. Chemically sharpened.

Code	025-95-...					
Size	01	02	03	04	05	06
Pcs/Bag	15	15	15	15	15	15

AKURA 250BR

BR Bronzed **Forged** **Twisted**

Bronzed, semi-forged with short shank bent and very strong wire. Round bend anti-disgorging and extra sharp point chemically sharpened. Ideal for carps.

Code	025-96-...				
Size	1/0	01	02	04	06
Pcs/Bag	15	15	15	15	15



1/0...009 1...010 2...020 4...040 6...060





AKURA 6001

N Nickel **●** Regular **▶** MicroBarb

Nickel plated hook, with round and thin wire, long shank, narrow bend, microbarb, high penetration chemically sharpened point. Universal purpose either in inland waters and at sea. Recommended baits: molluscs, salmon eggs, silkworms, shrimps and ver de vase etc.

Code	025-10-...					
Size	02	04	06	08	10	12
Pcs/Bag	15	15	15	15	15	15



2...020 4...040 6...060 8...080 10...100 12...120

AKURA 525N

N Nickel **●** Regular

Nickel-plated hook with long shank, medium-thin round wire. Narrow bend and high penetration point, anti-disgorging barb. Properly designed for mullet fishing. Recommended baits: pasta, bread and silkworms.

Code	025-85-...							
Size	04	06	08	10	12	14	16	18
Pcs/Bag	15	15	15	15	15	15	15	15



4...040 6...060 8...080 10...100 12...120 14...140 16...160 18...180

AKURA 535N

N Nickel **▶** Forged **▶** Twisted

Nickel plated hook, semi-forged, short-shank, strong wire, anti-disgorging round bend, reversed and chemically sharpened point. Micro barbels on the shank to keep a perfect baiting even after casting. Highly recommended for sea fishing.

Code	025-45-...				
Size	01	02	04	06	10
Pcs/Bag	15	15	15	15	15



1...010 2...020 4...040 6...060 8...080 10...100

AKURA 7535

N Nickel **▶** Forged **▶** Twisted

Nickel plated hook, semi-forged medium thin wire, semi-short shank, anti-disgorging round bend, chemically sharpened point and micro barb. Excellent for sea fish.

Code	025-60-...						
Size	04	06	08	10	12	14	16
Pcs/Bag	15	15	15	15	15	15	15



4...040 6...060 8...080 10...100 12...120 14...140 16...160

AKURA 910N

N Nickel **▶** Forged **▶** MicroBarb

Nickel plated hook featuring long shank, "S" special bend, chemically sharpened point and anti-disgorging barb. A microbarb on the shank ensures the fastening of the bait on the hook. For sea fishing when dealing with live baits.

Code	026-80-...					
Size	02	04	06	08	10	12
Pcs/Bag	15	15	15	15	15	15



2...020 4...040 6...060 8...080 10...100 12...120

AKURA 800SS

IX Inox **▶** Forged **▶** Ringed

Semi-forged, long shanked hook, with semi-round bend. Made of carbon special steel. Featuring high penetration point and anti-disgorging barb. Very strong.

Code	026-60-...							
Size	9/0	7/0	5/0	2/0	01	02	04	06
Pcs/Bag	3	4	6	10	10	10	10	10



9/0...001 7/0...003 5/0...005 2/0...008 1...010 2...020 4...040 6...060

SYMBOLS

1 Hook Size ...020 Product Code



AKURA 130BN

BN Black Nickel **●** Regular

Sea fishing hooks particularly indicated for sea bass and dorada.

Code	026-30...				
Size	02	04	06	08	10
Pcs/Bag	15	15	15	15	15

2...020 4...040 6...060 8...080 10...100

AKURA 135B

BK Black **●** Regular **○** Ringed

Designed for surfcasting, beachcasting and light depth fishing. Featuring a round bend, medium wire, black finish and ringed.

Code	026-35...				
Size	02	04	06	08	10
Pcs/Bag	15	15	15	15	15

2...020 4...040 6...060 8...080 10...100

AKURA 140BN

BN Black Nickel **●** Regular

Very good hook for deep fishing to sea bass, sea perch and snappers. Finish black nickel and with palette shank.

Code	026-40...				
Size	02	04	06	08	10
Pcs/Bag	15	15	15	15	15

2...020 4...040 6...060 8...080 10...100



Emiliano Tenerelli

AKURA 145BN

BN Black Nickel **●** Regular **○** Ringed

Same pattern of previous model but with eye shank. Same black nickel finish.

Code	026-45...				
Size	02	04	06	08	10
Pcs/Bag	15	15	15	15	15

2...020 4...040 6...060 8...080 10...100

AKURA 187N

N Nickel **●** Regular **▶** MicroBarb

4...040 5...050 6...060 7...070 8...080 10...100

Nickel plated straight hook, long shank, round bend, with chemically sharpened point. Best performance when used at sea and freshwaters.

Code	026-65...					
Size	04	05	06	07	08	10
Pcs/Bag	15	15	15	15	15	15

AKURA 115R

R Red **●** Regular **○** Ringed

2/0...008 1/0...009 1...010 2...020 4...040 6...060 8...080 10...100

Round bend ringed hook, red plated, chemically sharpened high penetration needle point and medium wire. Especially recommended for surfcasting, beachcasting and light depth sea fishing.

Code	026-37...							
Size	2/0	1/0	01	02	04	06	08	10
Pcs/Bag	6	8	10	10	10	10	10	10



AKURA 116N

N Nickel **Regular** **MicroBarb**

Nickel plated hook with large wire and round bend. High penetration point and anti-disgorging barb. Designed for mackerel fishing.



Code	026-70...							
Size	3/0	2/0	1/0	01	02	03	04	
Pcs/Bag	15	15	15	15	15	15	15	15

3/0...007 2/0...008 1/0...009 1...010 2...020 3...030 4...040

AKURA 11507BN

BN Black Nickel **Ringed** **Twisted** **Forged**

Black nickel plated hook, semi-forged wire and chemically sharpened reversed needle point. Anti-disgorging round bend, short-shank and high resistance barb. Excellent for sea fishing with live bait, both trolling or at depth.



Code	026-55...						
Size	8/0	6/0	4/0	3/0	2/0	1/0	
Pcs/Bag	3	5	9	11	12	13	

8/0...002 6/0...004 4/0...006 3/0...007 2/0...008 1/0...009

AKURA 9000

BN Black Nickel **Forged**

Black nickel plated hook, semi-forged, reversed and chemically sharpened point, anti-disgorging round bend, bent and semi-short shank, high resistance barb. Especially meant for carp fishing. Recommended baits: boilies, corn, paste, polenta, worms.



Code	025-40...											
Size	3/0	2/0	1/0	01	02	04	06	08	10	12	14	
Pcs/Bag	15	15	15	15	15	15	15	15	15	15	15	15

3/0...007 2/0...008 1/0...009 1...010 2...020 4...040 6...060 8...080 10...100 12...120 14...140

AKURA 9684BN

Black nickel hook with semi-forged wire, chemically sharpened reversed needle point. Excellent for surfcasting and for light sea fishing at depth, in particular for sea bass and dorado.

BN Black Nickel **Forged**
Twisted **Ringed**

Code	026-34...							
Size	02	04	06	08	10	12	14	
Pcs/Bag	15	15	15	15	15	15	15	15

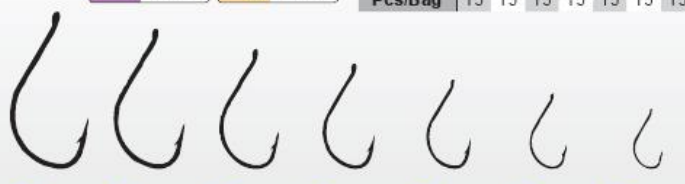

2...020 4...040 6...060 8...080 10...100 12...120 14...140

AKURA 9000BR

Bronzed series, semi-forged, reversed and with chemically sharpened point. Featuring a round bend, semishort shank. High resistance micro-barb. Especially developed for carps.

BR Bronzed **Forged** **Twisted**

Code	025-97...			
Size	04	06	08	10
Pcs/Bag	15	15	15	15



4...040 6...060 8...080 10...100

SYMBOLS

1 Hook Size ...020 Product Code

AKURA 9000N

Nickel plated semi-forged hook, strong, medium shank, bent, anti-disgorging round bend, chemically sharpened reversed point and high resistance micro barb. Excellent for sea fishing.

N Nickel **F** Forged **T** Twisted



Code	025-65...										
Size	3/0	2/0	1/0	01	02	04	06	08	10	12	14
Pcs/Bag	15	15	15	15	15	15	15	15	15	15	15

3/0...007 2/0...008 1/0...009 1...010 2...020 4...040 6...060 8...080 10...100 12...120 14...140

AKURA 300BN

Black nickel plated hook, semi forged medium shank, special anti-disgorging round bend, chemically sharpened reversed point and high resistance barb. For fishing big carps, sturgeons and sheats. Recommended baits: worms, paste, boilies.

BN Black Nickel **F** Forged **T** Twisted



Code	025-80...			
Size	01	02	04	06
Pcs/Bag	10	10	10	10

1...010 2...020 4...040 6...060

AKURA 400BN

Black nickel plated hook, eyed, high resistance steel made, special anti-disgorging round bend, chemically sharpened reversed point, semi-forged, high resistance barb. Suitable for carp, sheat, pike and sturgeon fishing.

BN Black Nickel **F** Forged **T** Twisted **R** Ringed



Code	026-10...			
Size	01	02	04	06
Pcs/Bag	10	10	10	10

1...010 2...020 4...040 6...060

AKURA 500BN

Black nickel plated hook, eyed, high penetration, high resistance barb, anti-disgorging round bend, chemically sharpened reversed point. For carp, pike and cat fish.

BN Black Nickel **F** Forged **T** Twisted **R** Ringed



Code	026-20...						
Size	3/0	2/0	1/0	01	02	04	06
Pcs/Bag	10	10	10	10	10	10	10

3/0...007 2/0...008 1/0...009 1...010 2...020 4...040 6...060

AKURA 600B

Black nickel plated hook, forged, back turned eye, special anti-disgorging round bend, chemically sharpened high penetration point and high resistance barb. Exceptional for catfish, carp, pike and sea fishing as well.

BK Black **F** Forged **R** Ringed

Code	026-50...		
Size	10/0	8/0	6/0
Pcs/Bag	5	5	5



10/0...000 8/0...002 6/0...004

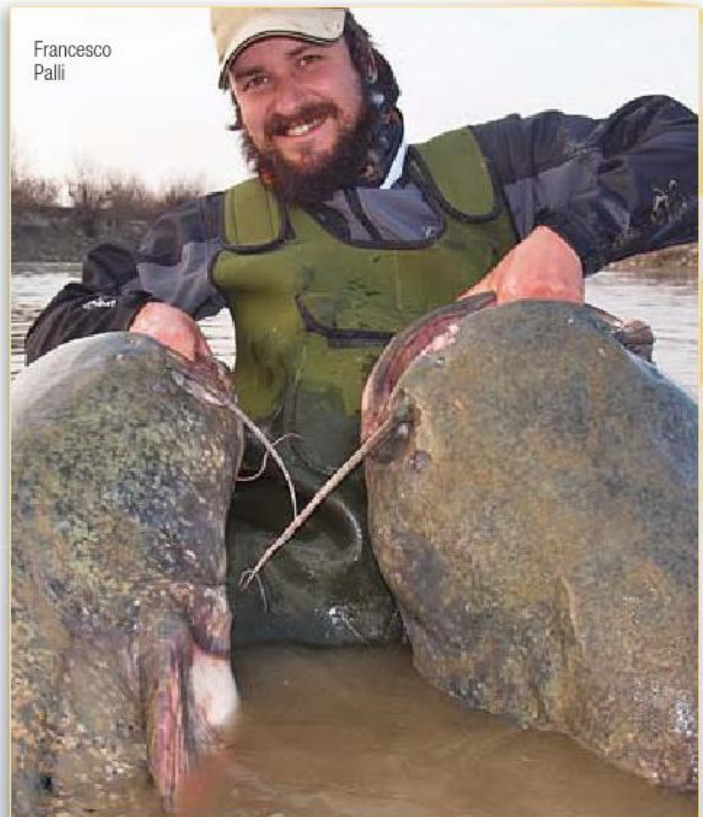

Francesco Palli



AKURA 9400

BR Bronzed **FORGED** Forged

Bronzed hook, long and straight shank, reversed and chemically sharpened point. Shank featuring two microbarbs allowing to tightly fasten large baits. Meant for eel fishing it is also recommended when fishing at sea.

Code	026-75...				
Size	01	02	04	06	08
Pcs/Bag	15	15	15	15	15



AKURA 5500N

N Nickel **MICROBARB** MicroBarb **FORGED** Forged

Nickel plated hook, semi-forged, medium wire, round bend, long shank, chemically sharpened needle point and anti-disgorging barb. Strong hook ideal for big fish sea fishing.

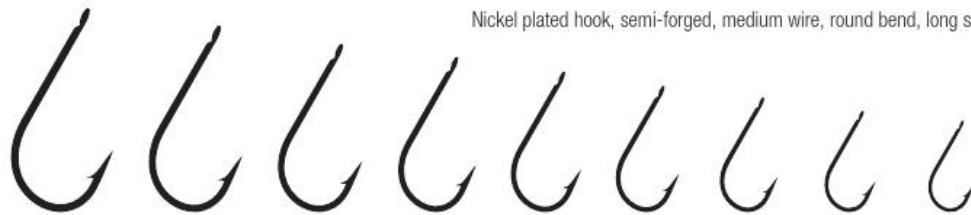

Code	025-55...									
Size	3/0	2/0	1/0	01	02	04	06	08	10	
Pcs/Bag	15	15	15	15	15	15	15	15	15	15

3/0...007 2/0...008 1/0...009 1...010 2...020 4...040 6...060 8...080 10...100

AKURA 5000N

N Nickel **FORGED** Forged **TWISTED** Twisted

Nickel plated hook, semi-forged, medium-thin wire, bent, with special anti-disgorging round bend, chemically sharpened point and high resistance micro barb. Ideal for sea bass.

Code	025-50...											
Size	1/0	01	02	04	06	08	10	12	14	16	18	
Pcs/Bag	15	15	15	15	15	15	15	15	15	15	15	15



1/0...009 1...010 2...020 4...040 6...060 8...080 10...100 12...120 14...140 16...160 18...180

MAGNETIC HOOK BOX

Double sided magnetic box. Each compartment has got a no magnetic inclined plane, allowing to take hooks out of the box easily. Supplied with two magnetic pencils.

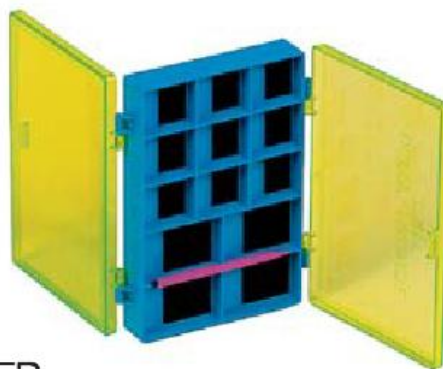

Code 103-65-100

DIAMOND HOOK SHARPENER

Rapture Hook sharpener is designed to sharpen your hooks perfectly. It will allow you to regenerate and sharpen to a needle point the hooks, suitable for all shapes and sizes.

Code 101-46-100



RYDER HOOKS

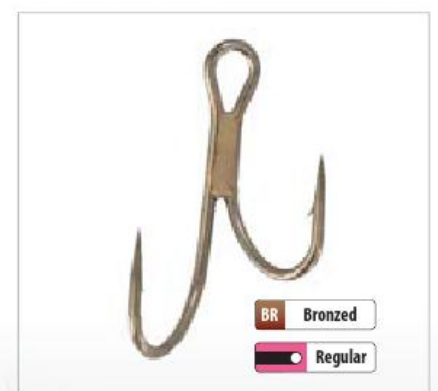

Code	Size	Pcs/Bag
026-94-008	2/0	5
026-94-009	1/0	5
026-94-010	01	5
026-94-020	02	5
026-94-040	04	5
026-94-060	06	5

AKURA TO NYLON

The Akura hooks are the bestselling hooks in the world, because their great quality and performances offered by the high carbon percentages and steel used in production. The points are chemically sharpened, hand tied with a Japanese monofilament of excellent quality, and checked by 5 different quality controls. They are extremely reliable and offered at a great value for money. Available in two versions: the booklet and the card, both containing 10 hooks..



CARASSIO 6000

Code	Size	Diameter	Length
028-40-030	06	0.200	150
028-40-040	08	0.160	150
028-40-045	08	0.180	150
028-40-050	10	0.160	150
028-40-055	10	0.180	150
028-40-060	12	0.140	150
028-40-065	12	0.160	150
028-40-070	14	0.120	150
028-40-075	14	0.140	150
028-40-080	16	0.120	150
028-40-085	16	0.100	150



CEFALO 525N

Code	Size	Diameter	Length
028-60-030	06	0.220	150
028-60-040	08	0.220	150
028-60-050	10	0.200	150
028-60-060	12	0.180	150



BREME 6000

Code	Size	Diameter	Length
028-55-008	08	0.180	150
028-55-010	10	0.160	150
028-55-012	12	0.140	150
028-55-014	14	0.120	150



CAVEDANI 6315

Code	Size	Diameter	Length
028-50-030	08	0.160	150
028-50-035	08	0.180	150
028-50-040	10	0.140	150
028-50-045	10	0.160	150
028-50-050	12	0.140	150
028-50-055	12	0.160	150
028-50-060	14	0.120	150
028-50-065	14	0.140	150
028-50-070	16	0.100	150
028-50-075	16	0.120	150
028-50-080	18	0.100	150
028-50-085	18	0.120	150
028-50-090	20	0.100	150
028-50-095	22	0.100	150



MAIS 9100

Code	Size	Diameter	Length
028-30-010	1/0	0.300	150
028-30-015	1/0	0.350	150
028-30-020	01	0.300	150
028-30-025	01	0.350	150
028-30-030	02	0.300	150
028-30-040	04	0.250	150
028-30-050	06	0.250	150
028-30-060	08	0.200	150

SERIES ON CARD



TROUT 200NY

Code	Size	Diameter	Length
028-10-010	02	0.200	200
028-10-015	02	0.220	200
028-10-020	03	0.180	200
028-10-025	03	0.200	200
028-10-030	04	0.180	200
028-10-035	04	0.200	200
028-10-040	05	0.180	200
028-10-045	05	0.200	200
028-10-050	06	0.160	200
028-10-055	06	0.180	200
028-10-060	07	0.160	200
028-10-065	07	0.180	200
028-10-070	08	0.160	200
028-10-075	08	0.180	200
028-10-080	10	0.140	200
028-10-085	10	0.160	200



CARP 9000

Code	Size	Diameter	Length
028-20-010	1/0	0.350	150
028-20-020	01	0.350	150
028-20-030	02	0.300	150
028-20-040	04	0.250	150
028-20-050	06	0.250	150
028-20-060	08	0.200	150

SERIES ON BOOKLET



CARP

Code	Size	Diameter	Length
027-20-005	1/0	0.350	70
027-20-010	01	0.350	70
027-20-011	01	0.300	70
027-20-020	02	0.300	70
027-20-040	04	0.250	70
027-20-060	06	0.250	70
027-20-080	08	0.200	70
027-20-100	10	0.180	70



ZANDER

Code	Size	Diameter	Length
027-15-005	1/0	0.300	70
027-15-010	01	0.300	70
027-15-020	02	0.300	70
027-15-040	04	0.250	70
027-15-060	06	0.250	70



BREME

Code	Size	Diameter	Length
027-25-060	06	0.200	70
027-25-080	08	0.180	70
027-25-100	10	0.160	70
027-25-120	12	0.140	70
027-25-140	14	0.120	70
027-25-160	16	0.120	70



TROUT

Code	Size	Diameter	Length
027-05-020	02	0.250	70
027-05-040	04	0.250	70
027-05-060	06	0.200	70
027-05-080	08	0.180	70
027-05-100	10	0.160	70
027-05-120	12	0.140	70



MAIS CARP

Code	Size	Diameter	Length
027-10-005	1/0	0.300	70
027-10-010	01	0.300	70
027-10-020	02	0.300	70
027-10-040	04	0.250	70
027-10-060	06	0.250	70
027-10-080	08	0.200	70



PRE-TIED RIGS

Series of rigs ready to use and developed and tested by World Champion anglers. Thirteen versions for every kind of ground bottom and fish species, assembled with first quality accessories on a special semi-soft spool on which they can be easily rewinded once used.



GREY MULLET SPECIAL

This 5 or 8 hooks rig has been designed and created for grey mullet fishing, but it has also proven attractive to many other species. It can be used in two different ways: 1) On the surface baited with a piece of stale bread - 2) On the bottom with a tangerine-sized ball of groundbait. For the latter application, Trabucco Team Master Mullet White groundbait is recommended.

Grey Mullet 5

Code	Size	Ø Main/Arm mm	Hooks	Length
027-54-020	02	0.40/0.30	5	-
027-54-040	04	0.35/0.30	5	-
027-54-060	06	0.35/0.30	5	-

Grey Mullet 8

Code	Size	Ø Main/Arm mm	Hooks	Length
027-56-020	02	0.40/0.35	8	-
027-56-040	04	0.35/0.30	8	-
027-56-060	06	0.35/0.30	8	-

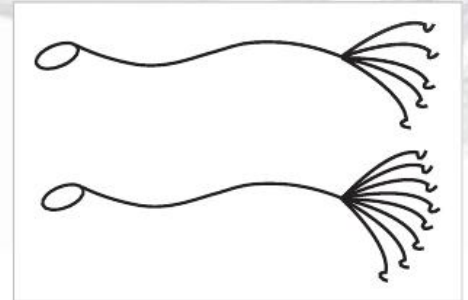

SPECIAL STRIPED BREAM 140-150

This rig has been designed and created for striped bream fishing and for sandy bottom fishing. It is used while drifting so that when the line is cast the rig lays out perfectly. The weight is attached to the swivel with a spring catch and the tip works with two hooks under the sinker and one above. Suitable for use on all sandy or muddy bottoms for catching striped bream, sea bream and gurnard.

Speciale MORMORA 140

Code	Size	Ø Main/Arm mm	Hooks	Length
027-60-040	04	0.35/0.30	3	140
027-60-060	06	0.35/0.30	3	140
027-60-080	08	0.35/0.30	3	140

Speciale MORMORA 150

Code	Size	Ø Main/Arm mm	Hooks	Length
027-62-020	02	0.35/0.30	3	150
027-62-040	04	0.35/0.30	3	150
027-62-060	06	0.35/0.30	3	150

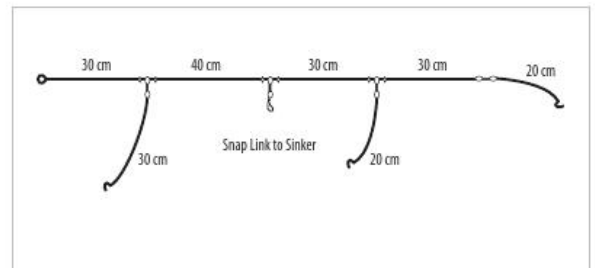

MACKEREL PLUS

This rig has been designed and created for fishing big chub mackerel. The large hooks can hold copious amounts of bait for even super size fish! Usually used in suspension with light weights or sometimes mounted on a line with a sliding float. It can also be used successfully for other techniques such as fishing from the shore.

Code	Size	Ø Main/Arm mm	Hooks	Length
027-74-020	02	0.40/0.30	3	180
027-74-040	04	0.35/0.30	3	180
027-74-060	06	0.35/0.30	3	180

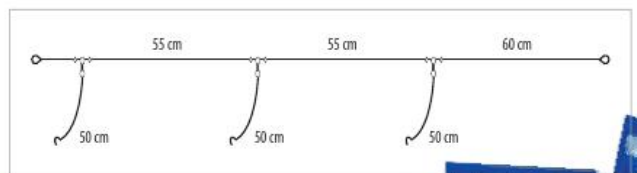

BAIT HOLDER



Hooks hand-tied with high quality monofilament. Ready to use with 20cm leader and ready-made buttonhole for quick substitution. Ideal for deep sea fishing and surf casting.

Code	Size	Diameter
027-80-008	2/0	0.500
027-80-009	1/0	0.500
027-80-010	01	0.400
027-80-020	02	0.400
027-80-040	04	0.400
027-80-060	06	0.350
027-80-080	08	0.350
027-80-100	10	0.300

ABERDEEN



Hooks hand-tied with high quality monofilament. Ready to use with 20cm leader and ready-made loop for easy substitution. Ideal for deep sea-fishing and surf casting.

Code	Size	Diameter
027-82-009	1/0	0.500
027-82-010	01	0.400
027-82-020	02	0.400
027-82-040	04	0.400
027-82-060	06	0.350
027-82-080	08	0.350
027-82-100	10	0.300



SABIKI

Sabiki rigs are the best way to fish from the boat for small pelagic predators such as mackerel and scad.

The chemically sharpened carbon hooks are equipped with feathers, fluorescent beads and fish skin. We suggest to use our rigs with a weight proportioned to the stream of the water. A too heavy lead will make your fishing not really good. Your Sabiki must always fluctuate in the stream.



Code	Size	Branch Line mm	Main Line mm
183-20-020/10	#06	0.33	0.37
183-20-030/10	#08	0.28	0.33
183-20-040/10	#10	0.28	0.33
183-20-050/10	#12	0.23	0.28



Code	Size	Branch Line mm	Main Line mm
183-20-110/20	#04	0.33	0.37
183-20-120/20	#06	0.33	0.37
183-20-130/20	#08	0.28	0.33
183-20-140/20	#10	0.28	0.33
183-20-150/20	#12	0.23	0.28



Code	Size	Branch Line mm	Main Line mm
183-20-210/20	#04	0.33	0.37
183-20-220/20	#06	0.33	0.37
183-20-230/10	#08	0.28	0.33
183-20-240/20	#10	0.28	0.33
183-20-250/20	#12	0.23	0.28

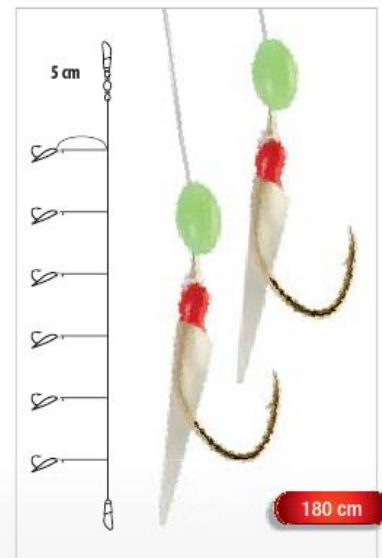

Code	Size	Branch Line mm	Main Line mm
183-20-310/20	#04	0.33	0.37
183-20-320/20	#06	0.33	0.37
183-20-330/20	#08	0.28	0.33
183-20-340/20	#10	0.28	0.33
183-20-350/20	#12	0.23	0.28



WATCH THE VIDEO

FUEDAY



Ready tied rigs for both freshwater and saltwater fishing, that can be used even without any live baits thanks to the special feathers and fish skins used to assemble them. With Sabiky you'll be able to catch fishes all around the world. Each rig have been tested for long time before its launch on the market. One of the most important advice is to try them with different size of leads, as they allow you to change the retrieve. Instead to use a lead you can try them with a feeder filled with groundbait, to stimulate the fishes to feed. Available in different combinations hook/monofilament, in many varieties and different colours.

Code	Hook Size	Branch Line mm	Colour
183-16-008/10	#08	0.400/0.300	Flash
183-16-010/10	#10	0.350/0.300	Flash
183-16-012/10	#12	0.350/0.300	Flash
183-16-014/10	#14	0.300/0.250	Flash
183-16-016/10	#16	0.250/0.200	Flash



Code	Size	Branch Line mm	Main Line mm
183-20-410/20	#06	0.33	0.37
183-20-420/20	#08	0.28	0.33
183-20-430/20	#10	0.28	0.33
183-20-440/20	#12	0.23	0.28

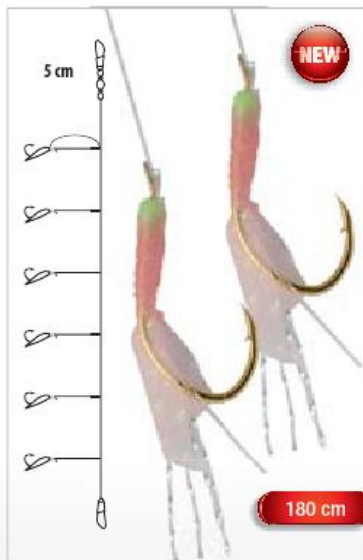

Code	Size	Branch Line mm	Main Line mm
183-20-510/20	#02	0.43	0.38
183-20-520/20	#04	0.37	0.33
183-20-530/20	#06	0.33	0.28
183-20-540/20	#08	0.33	0.28

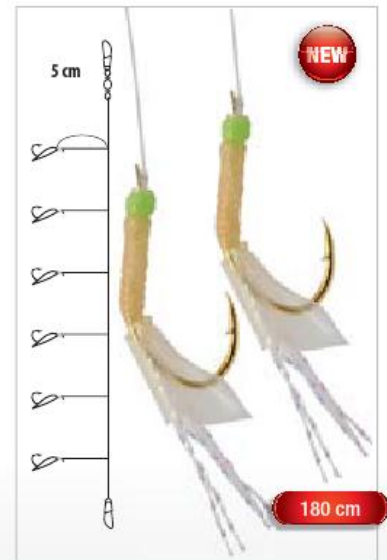

Code	Size	Branch Line mm	Main Line mm
183-20-610/20	#02	0.43	0.38
183-20-620/20	#04	0.37	0.33
183-20-630/20	#06	0.33	0.28
183-20-640/20	#08	0.33	0.28

FLOATS

The Trabucco catalogue floats section is a wide-angle shot showing how our Company is deeply involved in every aspect of fishing. You can find Hi Tech floats for competition and very good quality floats for passionate anglers, and they can be used both in fresh and salt water. The assortment is also rich of floats that can be used in combination with a chemical light. You cannot do without them if you are fishing in salt water or in carp fisheries night competitions.



DREAM TEAM 1

Competition float for still water, very good in a wind condition. The slim shape with the stainless steel stem and fluorescent glass fibre antenna are perfect for bloodworm fishing.

Size	
0.30	FIBREGLASS
0.50	
0.75	
1.00	
1.50	
2.00	

Code 001-22-010

DREAM TEAM 2

Competition float made by a top quality balsa wood with a carbon stem and long fluorescent fibre glass antenna. Very sensitive but very stable is good in a wind condition with the long poles.

Size	
0.50	FIBREGLASS
0.75	
1.00	
1.50	
2.00	
2.50	
3.00	
	CARBON

Code 001-22-020

DREAM TEAM 10

Competition float made by a top quality balsa wood with a stainless steel stem and long high visibility fluorescent fibre glass antenna. This float is perfect for fishing in steel water and moderate streams.

Size	
4x10	FIBREGLASS
4x12	
4x14	
4x16	
4x18	
1.00	
1.50	
	WIRE

Code 001-22-100

DREAM TEAM 13

Competition float made by a top quality balsa wood with a stainless steel stem and long high visibility fluorescent fibre glass antenna. Very stable this float is perfect for fishing in still and slow running water.

Size	
0.50	PLASTIC
0.75	
1.00	
1.25	
1.50	
2.00	
2.50	
3.00	
	WIRE

Code 001-22-130

ORACLE

Brand new float made with balsa body, stainless steel inox stem and high visibility antenna. Ideal for slowing down the bait in medium-strong flows.



Size	
0.50	PLASTIC
0.75	PLASTIC
1.00	PLASTIC
1.50	PLASTIC
2.00	PLASTIC
3.00	PLASTIC
4.00	WIRE
6.00	WIRE
8.00	WIRE
10.00	WIRE

Code 110-50-020

SPADE

Flat float designed in conjunction with the Ravanelli Team, with a balsa body and the antenna positioned parallel to the stem. Suited to medium running water to slightly holding back, while the lower sizes are perfect for fishing "blocked" in towing or slowing waters.



Size	
0.50	PLASTIC
0.75	PLASTIC
1.00	PLASTIC
1.50	PLASTIC
2.00	PLASTIC
2.50	PLASTIC
3.00	WIRE
4.00	WIRE
6.00	WIRE
8.00	WIRE
10.00	WIRE
15.00	WIRE
20.00	WIRE

Code 110-50-030

SPINNAKER

Lollipop float, with a perfect round shape and edges, in order to allow a perfect hold in any kind of stream. This specific shape allows the angler to keep the float steady, no matter how strong the flow.



Size	
0.30	PLASTIC
0.50	PLASTIC
0.75	PLASTIC
1.00	PLASTIC
1.50	PLASTIC
2.00	PLASTIC
3.00	WIRE
4.00	WIRE
6.00	WIRE
8.00	WIRE
10.00	WIRE
12.00	WIRE
15.00	WIRE

Code 110-50-010

NEW SUPREME SAIL

The slimmest flat float in the world performs brilliantly thanks to its narrow profile, which gets the minimum pressure from the water when it's hold dead still. Beyond the slimness, the body perimeter is well sharpened to let water run smoothly along its sides. The result is a very stable, vibration free float which enables to use a 20-30% lighter rig compared to traditional flat floats.



Size	
1.00	PLASTIC
1.50	PLASTIC
2.00	PLASTIC
3.00	PLASTIC
4.00	PLASTIC
6.00	WIRE
8.00	WIRE
10.00	WIRE
12.00	WIRE
15.00	WIRE
20.00	WIRE

Code 110-50-040

TEAM ITALY 8

This float is perfect to be used in running water, the Stainless steel stem and fiber antenna give total stability. Can be used also in still water in strong wind condition or when is necessary to fish in deep water.



Size	
0.50	FIBREGLASS
0.75	FIBREGLASS
1.00	FIBREGLASS
1.50	FIBREGLASS
2.00	FIBREGLASS
2.50	FIBREGLASS
3.00	WIRE
4.00	WIRE
5.00	WIRE
6.00	WIRE

Code 001-20-180

TEAM ITALY 9

Competition floats made to be used when fishing for bream and crucian carp in the bottom. The unique shape of the body allows to detect even the most delicate bite. Carbon stem and fiber-glass antenna.



Size	
0.75	FIBREGLASS
1.00	FIBREGLASS
1.50	FIBREGLASS
2.00	FIBREGLASS
2.50	FIBREGLASS
3.00	CARBON

Code 001-20-190

TEAM ITALY 11

Competition floats dedicated to fishing for bream and crucians carp. Optimal shape for still or slow waters, is perfect be used when fishing with bloodworm. Thin fiber-glass antenna and carbon stem.



Size	
4x14	FIBREGLASS
4x16	FIBREGLASS
4x18	FIBREGLASS
1.00	CARBON
1.50	CARBON
2.00	CARBON

Code 001-20-210

TEAM ITALY 12

Brand new series of high quality floats designed to meet the needs of the most demanding fishermen agonists Classic shape ideal for fishing in still or slow waters. Thin fiber-glass antenna and carbon stem.



Size	
4x14	FIBREGLASS
4x16	FIBREGLASS
4x18	FIBREGLASS
1.00	CARBON
1.50	CARBON

Code 001-20-220

TEAM ITALY 13

Competition float that can stand different water speed conditions and wind. The glass fibre tip allows the use of light baits, such as bloodworms or caster, fitted with a long carbon stem for stability. Particularly suited to bream or roach fishing, in big lakes where it's often towing.



Size	
4x14	FIBREGLASS
4x16	FIBREGLASS
4x18	FIBREGLASS
1.00	CARBON
1.50	CARBON
2.00	CARBON

Code 001-20-230

SUPREME PENCIL

Float designed for fishing in still waters or slow running, for delicate biting such as roach, carassio or bream. Featuring plastic hollow tip and carbon stem. It can be also used with success for winter fishing in carp fisheries.



HOLLOW CARBON

Code Size	001-26-320				
	4x12	4x14	4x16	4x18	1.00

SUPREME 7

Float made to be used with bolognese or even better the long pole in running water. On the lighter sizes is used from competition angler when fishing on the surface or at mid depth.



PLASTIC CARBON

Code Size	001-26-070				
	4x12	4x14	4x16	4x18	1.00 1.50 2.00 2.50 3.00

DREAM TEAM 5

Competition Float for versatile use with long carbon stem and plastic antenna with high visibility. It adapts to almost all fishing styles in still water even with moderate flow.



PLASTIC CARBON

Code Size	001-22-050				
	4x12	4x14	4x16	4x18	1.00 1.50 2.00 2.50 3.00

DREAM TEAM 4

Competition float made by a top quality balsa wood with a carbon stem and high visibility fluorescent plastic antenna. Very stable is good for fishing in low and medium running flows even in a wind condition.

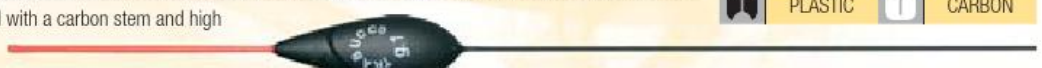

PLASTIC CARBON

Code Size	001-22-040				
	0.25	0.50	0.75	1.00	1.50 2.00 2.50 3.00

SUPREME 11

High tech inline competition float. It can be used at best both in fast flowing stream than in still water in windy days. Featuring plastic tip and carbon stem.



PLASTIC CARBON

Code Size	001-26-110									
	0.30	0.50	0.75	1.00	1.50	2.00	2.50	3.00	4.00	5.00 6.00 8.00 10.00

SUPREME 6

Float comes with stainless steel stem and plastic antenna with high sensitivity. Thanks to its drop shaped body, we recommend use with moderate or running waters.



PLASTIC WIRE

Code Size	001-26-060				
	4x8	4x10	4x12	4x14	4x16

SUPREME 2

Inner line float for running water fishing. Strong stainless steel stem and the new construction system. High visibility hollow antenna with an inner transparent fibre glass reinforcement.



INLINE HOLLOW WIRE

Code Size	001-26-020				
	1.00	1.50	2.00	2.50	3.00

SUPREME 3

Long tear drop shape perfect for still water and canal, lake and carp fisheries. Carbon stem size and high visibility hollow antenna size 1,2 & 1,5 mm.



HOLLOW CARBON

Code Size	001-26-030				
	4x14	4x16	4x18	1.00	1.50 2.00 2.50 3.00

SUPREME 4

Olive shape body very stable, perfect for still water and canal, lake and carp fisheries. Carbon stem and hollow tubular antenna size 1,2 and 1,5 mm.

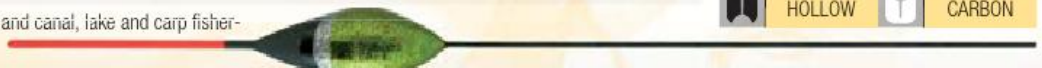

HOLLOW CARBON

Code Size	001 26 040				
	4x14	4x16	4x18	1.00	1.50 2.00 2.50 3.00

SUPREME 5

Very stable float perfect for fishing in running water or in windy conditions. Fitted with carbon stem and hollow tubular antenna size 1,2 and 1,5 mm.



HOLLOW CARBON

Code Size	001-26-050				
	4x14	4x16	4x18	1.00	1.50 2.00 2.50 3.00

R-INOX

Universal purpose float. Ideal in still and fast running waters. Excellent resistance to wind thanks to its perfect stability. With plastic fluo antenna and stainless steel long stem. Sizes from 0,50 up to 20,00 grams.



Size	14.00
0.50	16.00
0.75	18.00
1.00	20.00
1.50	
2.00	
2.50	
3.00	
4.00	
5.00	
6.00	
8.00	
10.00	
12.00	

Code | G R 0.5 - 8

R-CARBON

This is certainly one of the most used float patterns in several competitions both on lakes or in running water. Works perfectly in windy conditions. Made with carbon stem and a high visibility plastic antenna.



Size	
0.50	
0.75	
1.00	
1.50	
2.00	
2.50	
3.00	
4.00	
5.00	
6.00	
8.00	

Code | 001-08-010

SUPREME 8

Float designed to be used with long pole, ideal for both in still water or in the presence of moderate current. Comes with long carbon stem for extra stability and high visibility plastic antenna. Great for fishing crucians carp in the canal.



Size	
4x14	
4x16	
4x18	
1.00	
1.50	
2.00	

Code | 001-26-080

SUPREME 10

High tech inline competition float. It can be used at best both in fast flowing stream than in still water in windy days. Featuring plastic tip and carbon stem.



INLINE

Size	
0.30	
0.50	
0.75	
1.00	
1.50	
2.00	
2.50	
3.00	
4.00	
5.00	
6.00	
8.00	

Code | 001-26-100

SUPREME BOLO

In line float specially designed for heavy rigs building, both in calm and flowing waters. Featuring hollow high visibility tips and carbon stem.



INLINE

Size	
2.00	
3.00	
4.00	
5.00	
6.00	
8.00	
10.00	
12.00	
15.00	

Code | 001-26-300

SUPREME PISA

Series designed by the Team Ravanelli champions to compete in Pisa (river Arno) and everywhere you need an heavy duty float. In line model with plastic tip and carbon stem.



INLINE

Size	
2.00	
3.00	
4.00	
5.00	
6.00	
8.00	
10.00	
12.00	
15.00	

Code | 001-26-310

NEW CARP BLUE

A new generation of unbreakable pole floats, mainly destined to commercial lakes (carpodrome) as they can bear extreme pressure as well as any accidental shock. Their body is made from EVA (Ethilene Vinyl Acetate), an artificial material with a sponge-like structure which line can't cut. Having no metal eye, the rig line is completely straight, thus free from any damage.

NEW RACE CARP

In the commercial fishing (carpodrome) the float must bear any sort of stress and shock, with line tending to cut the body during extreme traction. That's why Trabucco developed these in-line floats for such matches.

HT1

REVERSIBLE BODY

INLINE

Size	
0.10	
0.20	
0.30	
0.50	
0.75	

Code | 001-27-100

HT2

REVERSIBLE BODY

INLINE

Size	
0.10	
0.20	
0.30	
0.50	
0.75	
1.00	

Code | 001-27-200

1

REVERSIBLE BODY

INLINE

Size	
0.10	
0.20	
0.30	
0.50	
0.75	

Code | 001-25-310

2

REVERSIBLE BODY

INLINE

Size	
0.10	
0.20	
0.30	
0.50	
0.75	

Code | 001-25-320

3

REVERSIBLE BODY

INLINE

Size	
0.10	
0.20	
0.30	
0.50	
0.75	

Code | 001-25-330

4

REVERSIBLE BODY

INLINE

Size	
0.10	
0.20	
0.30	

Code | 001-25-340

T - 2

Classic "Tesse" shaped float, suitable for all the fishing situations both in rivers and in the lake due to its high water penetration. Ideal for bleak fishing. Short plastic antenna and stainless steel stems.

Size	Material
4x10	PLASTIC
4x12	
4x14	
4x16	
4x18	WIRE
1.00	
1.25	
1.50	
1.75	
2.00	
2.50	



Code T2 4X12-2,5

C 1

Balsa elongated shaped float with collar, plastic antenna and short stainless steel stem. Is the best choice for bleak fishing and small fish in general.

Size	Material
4x10	PLASTIC
4x12	
4x14	
4x16	
4x18	WIRE
1.00	
1.25	
1.50	
2.00	
2.50	



Code C 1 4X10-2,5

I 2

Quill classic float for lake and medium running waters with extraordinary sensitivity. Plastic antenna and short stainless steel complete the equipment of this float.

Size	Material
4x14	PLASTIC
4x16	
4x18	
1.00	
1.25	WIRE
1.50	
1.75	
2.00	
2.50	



Code I 2 4X14 - 2,5

RACE 1

In line float with a classic upside down pear shaped body. Hollow antenna in the last section to ensure maximum visibility and strength. Ideal for bolognese.

Size	Material
1.00	HOLLOW
1.50	
2.00	
2.50	
3.00	
4.00	
5.00	CARBON
6.00	



INLINE

Code 001-25-200

RACE 2

In line float with a rugby ball shaped body. Hollow antenna in the last section to ensure maximum visibility and strength. Ideal for Bolognese and long-pole.

Size	Material
0.50	HOLLOW
0.75	
1.00	
1.50	
2.00	
2.50	
3.00	CARBON
4.00	
5.00	
6.00	



INLINE

Code 001-25-210

RACE 3

In line float with an elongated rugby ball shaped body. Hollow antenna in the last section to ensure maximum visibility and strength. Excellent for fishing in still or slow running waters.

Size	Material
0.50	HOLLOW
0.75	
1.00	
1.50	
2.00	
2.50	
3.00	CARBON
4.00	
5.00	
6.00	



INLINE

Code 001-25-220

ZEPHIR

A perfect float made for still water and lake. The new construction system has a one part carbon stem with hollow antenna and the line ring mounted directly on the carbon stem for extra strength.

Size	Material
4x12	HOLLOW CARBON
4x14	
4x16	
4x18	
1.00	CARBON
1.25	
1.50	
2.00	
2.50	



Code 001-25-120

ALISEO

A perfect float ideal for quarries or lakes, with long carbon stem and hollow high visibility cylindrical plastic antenna. Particularly suitable in conditions of instability and strong wind.

Size	Material
4x14	HOLLOW CARBON
4x16	
4x18	
1.00	
1.50	CARBON
2.00	
2.50	
3.00	
3.50	



Code 001-25-130

SCIROCCO

Float for still water ideal in strong wind. The new construction system has a one part carbon stem with hollow antenna and the line ring mounted directly on the carbon stem for extra strength.

Size	Material
4x14	HOLLOW CARBON
4x16	
4x18	
1.00	
1.50	CARBON
2.00	
2.50	
3.00	
3.50	



Code 001-25-150

BORA

Float made to be used in canal and in the lake. Carbon stem and hollow plastic antenna make it ideal for carp with heavy bait. Is very stable even in presence of strong wind. Excellent visibility.

Size	Material
4x10	HOLLOW CARBON
4x12	
4x14	
4x16	
4x18	
1.00	CARBON
1.50	
2.00	
2.50	
3.00	



Code 001-25-140

TORNADO

Float extremely robust for use in still water or slightly currents. Great in all seasons with corn and pellet. Equipped with fiber stem and hollow plastic antenna, which increases their visibility with the sunlight.

Size	Material
4x12	HOLLOW CARBON
4x14	
4x16	
4x18	
1.00	
1.50	CARBON
2.00	
2.50	
3.00	
3.50	



Code 001-25-160



LUCIFER CARP RX SERIES

This range has been developed for carp fishing in fisheries or open waters.

The hollow plastic antenna is jointed with the carbon stem inside trough the balsa body. This give to the float extra strength. The antenna have a spring eye at the base for perfect line fitting. The range have 9 different shape to cover all fishing situations.

LUCIFER CF X1

Size	4x14	4x16	4x18
Weight	1.00	1.00	1.50
Material	HOLLOW 2 MM		
Material	FIBREGLASS		



Code 001-18-010

LUCIFER CF X2

Size	4x14	4x16	4x18
Weight	1.00	1.00	1.50
Material	HOLLOW 2 MM		
Material	FIBREGLASS		



Code 001-18-020

LUCIFER CF X3

Size	4x12	4x14	4x16	4x18
Weight	1.00	1.00	1.00	1.00
Material	HOLLOW 1.5 MM			
Material	FIBREGLASS			



Code 001-18-030

LUCIFER CF X4

Size	4x12	4x14	4x16	4x18
Weight	1.00	1.00	1.00	1.00
Material	HOLLOW 1.5 MM			
Material	FIBREGLASS			



Code 001-18-040

LUCIFER CF X5

Size	4x10	4x12	4x14	4x16	4x18
Weight	1.00	1.00	1.00	1.00	1.00
Material	HOLLOW 1.5 MM				
Material	FIBREGLASS				



Code 001-18-050

LUCIFER CF X6

Size	4x10	4x12	4x14	4x16	4x18
Weight	1.00	1.00	1.00	1.00	1.00
Material	HOLLOW 1.5 MM				
Material	FIBREGLASS				



Code 001-18-060

LUCIFER CF X7

Size	4x10	4x12	4x14	4x16
Weight	1.00	1.00	1.00	1.00
Material	HOLLOW 2 MM			
Material	FIBREGLASS			



Code 001-18-070

LUCIFER CF X8

Size	4x10	4x12	4x14	4x16
Weight	1.00	1.00	1.00	1.00
Material	HOLLOW 2 MM			
Material	FIBREGLASS			



Code 001-18-080

LUCIFER CF X9

Size	4x10	4x12	4x14	4x16
Weight	1.00	1.00	1.00	1.00
Material	HOLLOW 2 MM			
Material	FIBREGLASS			



Code 001-18-090

AVATAR

Float with fibre stem, starlight holding tube for mm. 2.2 antenna featuring a balsa tapered body. Ideal for fishing in still waters.

Size	
0.20	
0.30	
0.50	
0.75	
1.00	
SMALL 2.2 MM	
FIBREGLASS	



Code 001-25-600

ATOMIC

Float with fibre stem featuring starlight holding tube for antenna of 2.2 mm. Tapered body towards the antenna. Ideal for fishing in calm waters or under windy conditions.

Size	
0.20	
0.30	
0.50	
0.75	
1.00	
SMALL 2.2 MM	
FIBREGLASS	



Code 001-25-610

CROWN

Upside down pear shaped in line float. Fiber stem and provided with a starlight fitting for 3.0mm antenna. Great for both freshwater and sea, it can be well employed also for lakes during the night.

Size	
0.20	
0.30	
0.50	
0.75	
1.00	
MEDIUM 3.0 MM	
FIBREGLASS	



Code 001-25-580

INLINE

CONDOR

Round shaped in-line float, with fiber stem and provided with a starlight fitting for 3.0mm antenna. Great allrounder for stillwaters, fisheries and slow running waters.

Size	
0.20	
0.30	
0.50	
0.75	
1.00	
MEDIUM 3.0 MM	
FIBREGLASS	



Code 001-25-690

INLINE

SENSOR

Great allrounder for stillwaters, fisheries both for fishing shallow or in the margins with big baits. Round shaped, in-line construction, glass stem and provided with a starlight fitting for 3.0mm antenna.

Size	
0.20	
0.30	
0.50	
0.75	
1.00	
MEDIUM 3.0 MM	
FIBREGLASS	



Code 001-25-590

INLINE

NADIR

Great allrounder for the bolo and the telepole. The 3mm high visibility multicolor antenna can be easily replaced with a chemical light. The line through the body and the built-in eyelet provide a good strength.



INLINE  MULTICOLOR 3 MM  FIBREGLASS

Code	001 25 620						
Size	1.00	1.50	2.00	3.00	4.00	5.00	6.00

GLOBAL

Carrot shaped float which provide great stability for the bolo or telepole, particularly suited to sea fishing. The in-line body and the built-in eyelet provide good strength. The 3mm high visibility multicolor antenna can be replaced with a chemical light.



INLINE  MULTICOLOR 3 MM  FIBREGLASS

Code	001-25-630						
Size	1.00	1.50	2.00	3.00	4.00	5.00	6.00

LAKE STAR

High visibility multicolor antenna, very sensitive with spring ring. Comes with fiberglass stem, good for use with telescopic whips in still water or moderate flows.



 MULTICOLOR 2 MM  FIBREGLASS

Code	001-25-560				
Size	1.00	1.50	2.00	3.00	4.00

LIBRA

"Upside down" drop shaped float with upper part varnished in fluo colour for a better visibility. Fitted with 3.0 mm. antenna replaceable with starlight. Long fibre stem. Ideal for flowing water.



 MEDIUM 3 MM  FIBREGLASS

Code	001-10-230					
Size	1.00	2.00	3.00	4.00	5.00	6.00

STRIKE STAR

In line float for sea fishing. Strike has a spherical body, fiber stem and provided with a starlight fitting for 3.0mm antenna.



Size	
1.00	MEDIUM 3.0 MM
1.50	
2.00	
2.50	
3.00	
3.00	
FIBREGLASS	



Code 001-25-570

RED STAR

Upside down pear shaped in line float. Fiber stem and provided with a starlight fitting for 3.0mm antenna. Great for both freshwater and sea.



Size	
1.00	MEDIUM 3.0 MM
1.50	
2.00	
2.50	
3.00	
6.00	
FIBREGLASS	



Code 001-25-540

ORANGE STAR

In line float with fiber stem and provided with a starlight fitting for 3.0mm antenna. Great for both freshwater and sea.



Size	
1.00	MEDIUM 3.0 MM
1.50	
2.00	
2.50	
3.00	
6.00	
FIBREGLASS	



Code 001-25-550

BLU STAR

A perfect float developed for Bolognese style. Provided with starlight fitting for mm.3.0 antenna and fibreglass stem. Excellent stability in water.



Size	
1.00	MEDIUM 3.0 MM
1.50	
2.00	
3.00	
4.00	
6.00	
FIBREGLASS	

Code 001-25-520

SILVER STAR

Drop float with fiber stem and 3.0mm starlight holding plastic antenna. Ideal for flowing waters is made to be used with Bolognese or telescopic whips.



Size	
1.00	MEDIUM 3.0 MM
1.50	
2.00	
3.00	
4.00	
6.00	
FIBREGLASS	

Code 001-25-530

GOLD STAR

Float with fiber stem and high visibility plastic antenna. Provided with starlight fitting for mm.3.0 antenna. Ideal for fishing in the Hollow or in medium flows.



Size	
0.30	MEDIUM 3.0 MM
0.50	
0.75	
1.00	
1.50	
3.00	
FIBREGLASS	

Code 001-25-500

GREEN STAR

Multipurpose float with fiber stem and high visibility plastic antenna. Provided with starlight fitting for mm.3.0 antenna. Ideal for all fishing conditions.



Size	
0.30	MEDIUM 3.0 MM
0.50	
0.75	
1.00	
1.50	
3.00	
FIBREGLASS	

Code 001-25-510

URANS

Classic upside down pear shape with interchangeable 3mm plastic antenna, fitted on a plastic bush with built-in eyelet to increase strength and long fiber stem for extra stability. Excellent for slow running waters.



Size	
1.00	MEDIUM 3.0 MM
1.50	
2.00	
3.00	
4.00	
5.00	
FIBREGLASS	

Code 001-25-400

SOMO

Great allrounder for the bolo or the tele pole. Drop shaped body and 3mm plastic antenna fitted on a plastic bush with built-in eyelet to increase strength. The antenna can be easily replaced by a chemical light.



Size	
1.00	MEDIUM 3.0 MM
1.50	
2.00	
3.00	
4.00	
5.00	
FIBREGLASS	

Code 001-25-410

ECSTASY

Long shaped body, perfect for fishing in stillwaters such as lakes or canals, both with bolo and the pole. The 3mm plastic antenna fitted on a plastic bush with built-in eyelet to increase strength.



Size	
1.00	MEDIUM 3.0 MM
1.50	
2.00	
3.00	
4.00	
4.00	
FIBREGLASS	

Code 001-25-420

MAXALL

"Upside down" drop shaped In line float, fiber stem and 4,5mm starlight holder. This float is the ideal for fishing anywhere. Body section in fluorescent colour.



Size	
2.00	
3.00	
4.00	
5.00	
6.00	
8.00	

LARGE 4.5 MM

FIBREGLASS



Code 001-25-800

PHANTOM

Inline drop shaped float, fiber stem and 4,5mm starlight holder. Ideal for fishing at sea or in streaming waters.



Size	
2.00	
3.00	
4.00	
5.00	
6.00	
8.00	

LARGE 4.5 MM

FIBREGLASS



Code 001-25-810

REBEL

Classic upside down pear shape with 4.5mm plastic antenna replaceable with starlight and long fiber stem. Excellent in running flows but also at sea.



Size	
2.00	
3.00	
4.00	
5.00	
6.00	
8.00	

LARGE 4.5 MM

FIBREGLASS

Code 001-25-700

VORTEX

"Upside down" round shaped float with upper part varnished in fluo colour for a better visibility. Fitted with mm. 4.5 antenna replaceable with starlight. Long fibre stem. Ideal for flowing water.



Size	
2.00	
3.00	
4.00	
5.00	
6.00	

LARGE 4.5 MM

FIBREGLASS

Code 001-25-710

BREEZE

Tapered float for an excellent sensitivity combined with good stability even in windy conditions. It has the upper body painted fluorescent for better visibility, Fitted with mm. 4.5 antenna replaceable with starlight. Suitable for still or slow waters.



Size	
1.00	
2.00	
3.00	
4.00	
5.00	

LARGE 4.5 MM

FIBREGLASS

Code 001-25-720

PRINCE

Float with starlight plastic holder and fibre stem. Excellent stability in water. Extraordinary for bolognese style fishing and good also for sea.



Size	
2.00	
3.00	
4.00	
5.00	
6.00	
8.00	
10.00	

LARGE 4.5 MM

FIBREGLASS

Code 001-25-730

DISCOVERY

Long shaped float. The upper part of the body is fluo painted, to give a better visibility. Starlight holder of 4,5mm and fiberglass stem. Recommended both for fresh and sea water fishing.



Size	
1.00	
2.00	
3.00	
4.00	
5.00	
6.00	
8.00	
10.00	

LARGE 4.5 MM

FIBREGLASS

Code 001-25-740

ALTAIR PRO

"Upside down" tear drop float. Fibreglass stem and starlight holding plastic antenna.



Size	
1.00	
1.50	
2.00	
2.50	
3.00	
4.00	
5.00	
6.00	

LARGE 4.5 MM

FIBREGLASS

Code 001-10-175

PHOENIX PRO

Tear drop shape float with fibre stem and starlight holding plastic antenna. Ideal for flowing waters.



Size	
1.00	
1.50	
2.00	
4.00	
5.00	
6.00	

LARGE 4.5 MM

FIBREGLASS

Code 001-10-185

SMASH

Drop shaped float with mm. 4.5 plastic antenna, replaceable with starlight, long fibre stem. For Bolognese style fishing in streaming and moving waters.



Size	
2.00	
3.00	
4.00	
5.00	
6.00	
8.00	
10.00	

LARGE 4.5 MM

FIBREGLASS

Code 001-25-750

MARINER

Ideally suited for fishing in presence of wind, waves or tow. Inline classic upside down pear shaped float with 4.5mm multicolour plastic antenna replaceable with chemical light and long fiber stem.



Size	
1.00	MULTICOLOR 4.5
1.50	
2.00	
3.00	
4.00	
5.00	
6.00	
	FIBREGLASS

INLINE

Code 001-25-840

MERCURY

Inline round body shaped float, designed for fishing in strong currents or windy conditions, ideal for docks and canals. Multicolor high visibility antenna that can be replaced with 4.5mm chemical light or contain within itself the 3mm.



Size	
1.00	MULTICOLOR 4.5
1.50	
2.00	
3.00	
4.00	
5.00	
6.00	
	FIBREGLASS

INLINE

Code 001-25-850

MAREA

Inline classic upside down pear shaped float with 4.5mm multicolour plastic antenna replaceable with starlight and long fiber stem. Very suitable in the presence of wind or waves.



Size	
1.00	MULTICOLOR 4.5
1.50	
2.00	
3.00	
4.00	
5.00	
6.00	
	FIBREGLASS

INLINE

Code 001-15-350

ONDA

Inline shaped float ideal for fishing in current, ideal for docks and canals. multicolor high visibility antenna that can be replaced with 4.5mm starlight or contain within itself the 3mm.



Size	
1.00	MULTICOLOR 4.5
1.50	
2.00	
3.00	
4.00	
5.00	
6.00	
	FIBREGLASS

INLINE

Code 001-15-340

ICARUS

Classic upside down pear shape with interchangeable 4.5mm plastic antenna, fitted on a plastic bush with built-in eyelet to increase strength and long fiber stem for extra stability. Excellent for bolo in strong current.



Size		
2.00	LARGE 4.5 MM	
3.00		
4.00		
5.00		
6.00		
8.00		
10.00		
		FIBREGLASS

Code 001-25-760

SPECTOR

Slider float with a round shaped body, line trough the body with tube and rivet. Glass stem with metal foot. Multicolor high visibility antenna that can be replaced with 4.5mm starlight or contain within itself the 3mm.

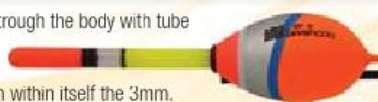

INLINE MULTICOLOR 4.5 MM FIBREGLASS

Code	001-25-860
Size	4.00 6.00 8.00 10.00 15.00 20.00

NAVY

Slider float with a drop shaped body, line trough the body with tube and rivet. Glass stem with metal foot. Multicolor high visibility antenna that can be replaced with 4.5mm starlight or contain within itself the 3mm.

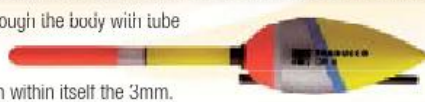

INLINE MULTICOLOR 4.5 MM FIBREGLASS

Code	001-25-870
Size	4.00 6.00 8.00 10.00 15.00 20.00

SHUTTLE

Sliding drop shaped float. Hollow stainless steel stem and mm. 4.5 antenna replaceable with starlight. Ideal for fishing in rough water both at sea and in lakes.



INLINE MULTICOLOR 4.5 MM INOX TUBE

Code	001-25-820
Size	2.00 4.00 6.00 8.00 10.00

STARFIRE

Sliding float and hollow stainless steel stem and mm. 4.5 antenna replaceable with starlight. Extremely stable, it is excellent for fishing on deep water. Ideal for fishing at sea and in freshwater.



INLINE MULTICOLOR 4.5 MM INOX TUBE

Code	001-25-830
Size	2.00 4.00 6.00 8.00 10.00

UNIX

Great allrounder for the bolo or the tele pole. Drop shaped body and 4.5mm plastic antenna fitted on a plastic bush with built-in eyelet to increase strength. The antenna can be easily replaced by a chemical light.



Size	Antenna
1.00	LARGE 4.5 MM
1.50	
2.00	
3.00	
4.00	
5.00	
6.00	
FIBREGLASS	

Code 001-25-430

GALAXY

Classic upside down pear shape with interchangeable 4.5mm plastic antenna, fitted on a plastic bush with built-in eyelet to increase strength and long fiber stem for extra stability. Excellent for slow running waters.



Size	Antenna
1.00	LARGE 4.5 MM
1.50	
2.00	
3.00	
4.00	
5.00	
6.00	
FIBREGLASS	

Code 001-25-440

SUN

Long shaped body, perfect for fishing in stillwaters such as lakes or canals, both with bolo and the pole. The 4.5mm plastic antenna fitted on a plastic bush with built-in eyelet to increase strength.



Size	Antenna
2.00	LARGE 4.5 MM
3.00	
4.00	
5.00	
6.00	
FIBREGLASS	

Code 001-25-450

TORK

Great allrounder for the bolo or the tele pole. Upside down pear shaped body and 4.5mm plastic antenna fitted on a plastic bush with built-in eyelet to increase strength. The antenna can be easily replaced by a chemical light.



Size	Antenna
2.00	LARGE 4.5 MM
3.00	
4.00	
5.00	
6.00	
FIBREGLASS	

Code 001-25-460

LYNX

Featuring a long fibre stem, a mm. 3 antenna replaceable with star-light and thanks to its particular drop shape, this float is the ideal for fishing anywhere. Body section in fluorescent colour.



Size	Antenna
1.00	MULTICOLOR 4.5MM
2.00	
3.00	
4.00	
5.00	
6.00	
FIBREGLASS	

Code 001-12-020

ADVANCED RX SERIES

A floats selection purpose studied for satisfying varied demands of fishing, both in sea and in fresh waters. All the floats are made by hand with particular very resistant balsa wood. Manufactured in blister pack they distinguish for a good relationship between quality and price.

Code	Model	Size
001-12-100	Advanced RX 1	0.30-0.50-0.75
001-12-110	Advanced RX 1	1.00-1.50-2.00
001-12-130	Advanced RX 2	1.00-1.50-2.00
001-12-140	Advanced RX 3	0.30-0.50-0.75
001-12-150	Advanced RX 3	1.00-1.50-2.00
001-12-160	Advanced RX 4	1.00-1.50-2.00
001-12-200	Advanced RX Slider	4.00-6.00



RX 1



RX 2



RX 3



RX 4



RX SLIDER



WINNER 1

Allround float with a buoyant balsa antenna, highly visible in every conditions. The carbon stem ensure a good stability, suitable for fishing in lakes or slow running waters.



Size	1.00	1.50	2.00	3.00
	BALSA			
	CARBON			

Code | 001-06-001

WINNER 2

Allround float with an upside down tear shaped body and balsa antenna. Carbon stem, suitable for running waters or sea fishing.



Size	1.00	1.50	2.00	3.00
	BALSA			
	CARBON			

Code | 001-06-002

WINNER 3

Light waggler entirely made by balsa wood, suitable for short distance fishing. It features a highly buoyant antenna, for fishing with big baits or in slow running waters. It can be used as a standard floats with the addition of a silicon tube on the top.



Size	2.00	3.00	4.00	6.00	8.00
	BALSA				
	CARBON				

Code | 001-06-003

WINNER HV 113

Pencil shaped float, tapered on top, suitable for fishing in lakes and in particular for trout fishing. It features a buoyant balsa antenna and carbon stem.



Size	2.00	3.00	4.00	6.00
	BALSA			
	CARBON			

Code | 001-06-113

WINNER HV 114

Highly sensitive and stable this float features a pencil shaped body with a buoyant balsa antenna and carbon stem.



Size	2.00	3.00	4.00	6.00
	BALSA			
	CARBON			

Code | 001-06-114

WINNER HV 115

Short pencil shaped float suitable for lake fishing in particular to trout and other predators. Very strong and visible, it can be used for bolo or telepole fishing as well. Balsa antenna and inox stem.



Size	1.00	2.00	3.00	4.00
	BALSA			
	CARBON			

Code | 001-06-115

WINNER SP 201

Long shaped float suitable for fishing in still or slightly running waters. Multicolour hollow antenna, for a perfect visibility in every conditions and long carbon stem to increase stability. Perfect for sea fishing.



Size	1.00	1.50	2.00	3.00	4.00
	MULTICOLOR TUBE				
	CARBON				

Code | 001-06-201

WINNER SP 202

Upside down drop shaped float, perfect for flowing waters and sea fishing. Long multicolour hollow antenna, for a perfect visibility in every conditions and long carbon stem to increase stability. Highly sensitive.



Size	1.00	1.50	2.00	3.00	4.00
	MULTICOLOR TUBE				
	CARBON				

Code | 001-06-202

WINNER SP 203

Long drop shaped float, particularly suitable for still waters or sea in windy conditions. Multicolour hollow antenna, to increase visibility and long carbon stem for the maximum stability.



Size	1.00	1.50	2.00	3.00	4.00
	MULTICOLOR TUBE				
	CARBON				

Code | 001-06-203

WINNER SP 204

Suitable for fishing in canals or lakes to bream, crucian and gardons, when sensitivity is required. Carbon stem and high visibility plastic antenna.



Size	1.00	1.50	2.00	3.00
	PLASTIC			
	CARBON			

Code | 001-06-204

WINNER SP 205

Long drop shaped float suitable for fishing in still waters. The stainless steel stem delivers a great stability in windy days. High visibility plastic antenna.



Size	1.00	1.50	2.00	3.00
	MULTICOLOR TUBE			
	CARBON			

Code | 001-06-205

WINNER SP 206

Long shaped float for the maximum sensitivity fishing into lakes or still waters generally. Perfect for bream and gardon. Carbon stem & antenna.



Size	1.00	1.50	2.00	2.50	3.00
	CARBON				
	CARBON				

Code | 001-06-206

XD CARBON MATCH

Hi-Tech waggler with adjustable weight, fitted with a carbon hollow tube instead of the traditional peacock quill. This solutions allows to increase significantly the sensitivity and the stability, thanks to the lower frictions. Therefore ideal for large lakes and canals, where wind and tow may be a problem. Suited for bottom fishing, in particular for bream to detect with ease lift-up bites.

Code Size	010-84-120	010-84-140	010-84-160	010-84-180	010-84-200	010-84-250
	12	14	16	18	20	25



XD CARBON BREME

Waggler float fitted with a carbon hollow tube instead of the traditional peacock quill, adjustable weights. Designed in conjunction with Gianuigi Sorti and the Ravanelli Team, the result is an extremely stable and sensible waggler, particularly suited for bream fishing both fixed or slider. Supplied with an low diameter antenna and the high visibility PVC tube for the more delicate bites.

Code Size	010-85-120	010-85-140	010-85-160	010-85-180	010-85-200
	12	14	16	18	20



XD WING

Bodied waggler with a straight peacock quill, provided with wings to stabilize the float during the casts. The ogival balsa body features an adjustable free corrosion brass weight. It has shotting capacity from 0 up to 5 grs. Supplied with two interchangeable tips of 3,5mm plus a side 7mm cane tip for extreme distances.

Code Size	010-72-100	010-72-120	010-72-140	010-72-160	010-72-180	010-72-200	010-72-220	010-72-250	010-72-300
	10	12	14	16	18	20	22	25	30



XD MATCH

Bodied waggler with a straight peacock quill. The drop shaped balsa body features an adjustable free corrosion brass weight. It has shotting capacity from 0 up to 5grs. Supplied with two interchangeable tips of 3,5mm plus a 5mm., suitable for slider fishing.

Code Size	010-70-100	010-70-120	010-70-140	010-70-160	010-70-180	010-70-200	010-70-220	010-70-250
	10	12	14	16	18	20	22	25



XD SLIDER

Bodied waggler with balsa body and peacock quill stem, specifically designed for slider fishing. It features a brass adjustable weight plus a special adaptor to be connected to a special float attachment. Supplied with two interchangeable tips of 3,5mm plus a 5mm, suitable for slider fishing.

Code Size	010-71-110	010-71-120	010-71-140	010-71-160	010-71-180	010-71-200
	10	12	14	16	18	20



ANTENNE XD

The top aluminium bush is designed to accommodate three different diameters antennas, for the maximum customization.



Code	Model	Pcs
010-70-010	XD Insert 3.0mm	10
010-70-020	XD Insert 5.0mm	10
010-70-030	XD Fischione	10
010-70-040	XD Set di Antenne	3

XD OSTELLATO

New waggler equipped with polycarbonate stem that is much lighter and resistant than the peacock quill. Therefore, it is straight and precise during cast. It can be used in all situation thanks to its features to adjust the shotting capacity from 0 to up 5grs. and can fit the insert 3mm.

Code	010-83-100	010-83-120	010-83-140	010-83-160	010-83-180	010-83-200	010-83-220	010-83-250	010-83-300
Size	10	12	14	16	18	20	22	25	30



XD ULTIMATE

The Ultimate is assembled with polycarbonate stem much lighter and resistant than peacock quill. Born for competitions is deadly in running flows and in the sea. The shotting capacity from 0 to up 5grs is adjustable while the antenna is painted with high visibility paint.

Code	010-82-100	010-82-120	010-82-140	010-82-160	010-82-180	010-82-200	010-82-220	010-82-250	010-82-300
Size	10	12	14	16	18	20	22	25	30



XD MAGIC

XD Magic is a true allrounder bodied waggler, featuring a long antenna for maximum stability during flight and once settled into the water. The antenna is made by a polycarbonate tube, totally no deformable material. The adjustable brass weight allow the adjustment from 0 up to 5g on the line.

Code	010-86-120	010-86-140	010-86-160	010-86-180	010-86-200
Size	12	14	16	18	20



XD CANAL

Classic bodied waggler for short and medium distance, featuring an adjustable free corrosion brass weight. It has shotting capacity from 0 up to 3 grs. The short quill make it perfect for shallow fishing or canal fishing.

Code	010-75-060	010-75-080	010-75-100	010-75-120	010-75-140
Size	6	8	10	12	14



XD BREME

Classic bodied waggler for short and medium distance. The interchangeable antenna allows the angler to select the color that best suits the environmental conditions. Loaded in brass,

fitted with adjustable small discs enables different weights to be used on the line. Is perfect when fishing for bream, crucian carp and carp.

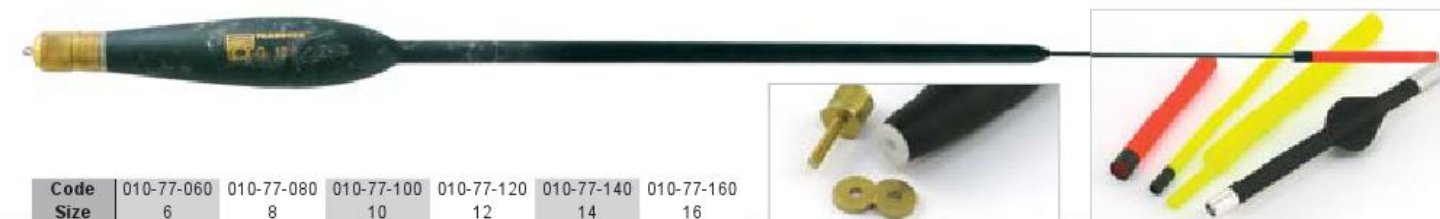

Code	010-77-060	010-77-080	010-77-100	010-77-120	010-77-140	010-77-160
Size	6	8	10	12	14	16

XD HI-VIZ

Balsa bodied waggler with high visibility PVC antenna. Perfect for short and medium distance in lakes or sea.

Code	010-78-090	010-78-110	010-78-130	010-78-150
Size	8+1	10+1	12+1	14+1



GHOST MATCH

New waggler floats made with polycarbonate stem and totally waterproof polyurethane body, extremely resistant to heat and shock. Both models are fitted with removable weights, to allow the fine adjustment of the weight depending on conditions. In the model 45 is possible

to replace the antenna with a 4.5mm chemical light, while for the model 30 is possible to use a 3mm one. Deadly both in fresh or salt water.



GHOST MATCH 30

Code	010-81-040	010-81-060	010-81-080	010-81-100	010-81-120
Size	4	6	8	10	12

GHOST MATCH 45

Code	010-80-060	010-80-080	010-80-100	010-80-120	010-80-150	010-80-200
Size	6	8	10	12	15	20

RAINBOW MATCH

The most visible waggler, It combines an exceptional sensitiveness, stability to an excellent bite detection. Balsa tapered body and multicolour tube antenna. A great allrounder waggler, perfectly suited to most conditions.

Code	001-31-040	001-31-060	001-31-080	001-31-100	001-31-120
Size	2+2	4+2	6+2	8+2	10+2



CLASSIC MATCH

Classic English float in sarkanda quill and bulb in balsa wood. Loaded in brass, fitted with adjustable small discs, you can put a different weight on the line. Recommended when fishing on the wind thanks to the special body shape.

Code	010-39-140	010-39-160	010-39-180
Size	12+2	14+2	16+2



CRISTAL

New waggler made in polycarbonate that is heat-resistant, even after many hours under the sun rays. Supplied with a 4,5mm bush can be use with a chemical light. Suggested for sea fishing or lake fishing at medium distance. The crystal transparent body don't make the shadow in the water.

Code	001-87-080	001-87-100	001-87-120	001-87-140	001-87-170
Size	6+2	8+2	10+2	12+2	15+2



DIAMOND STARLIGHT

Straight Insert float made of transparent high quality polycarbonate, resistant to shock and heat. Fitted with a 3 or 4.5mm antenna according to the sizes. It can be shotted with 1g down the line and the antenna can be interchanged with a chemical light.

Code	010-45-030	010-45-040	010-45-050	010-45-060
Size	2+1	3+1	4+1	5+1



MONSTER AGUGLIA

Short shaped waggler suitable for sea fishing and shallow fishing in lakes. Made by balsa, it features a fixed brass weight with an interchangeable 4,5mm plastic antenna.

Code	001-32-030	001-32-040	001-32-060	001-32-080	001-32-100	001-32-120
Size	2+1	3+1	4+2	6+2	8+2	10+2

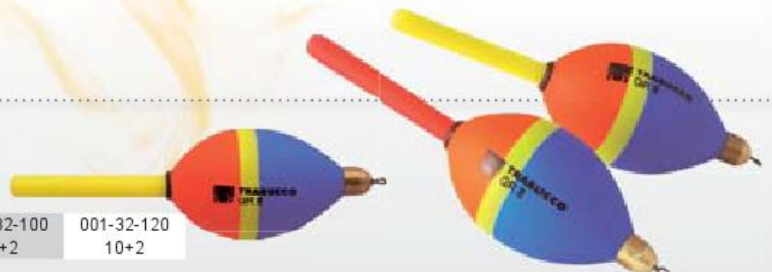

WINNER SP 207

Light waggler to fish at short distances, suitable also for fishing with a telepole. High visibility multicolour antenna, to detect also the lightest bites. Particularly suitable for breme, gardon and carp as well.

Code	001-06-207	001-06-207	001-06-207	001-06-207
Size	2.00	2.50	3.00	4.00



WINNER SP 208

Light waggler with a long carbon antenna plus a high visibility top, super sensitive and stable also in windy conditions. Particularly suitable for fishing at short distances for breme, gardon and carassio.

Code	001-06-208	001-06-208	001-06-208	001-06-208
Size	2.00	3.00	4.00	6.00



MARKER TROLLER

Float designed for trolling with live or dead baits. The shaped tube is used to adjust the fishing depth, avoiding that it does not slip down towards the bait when trolling or retrieved. The Red fluo painted tip guarantees an excellent visibility in every conditions.



MARKER AGGRESSOR

Float series products in transparent epoxy material. The ends are painted with fluorescent paint for high visibility. Available in different configurations, they lend themselves to various fishing situations, including long distance. Excellent for fishing at sea and in fresh water and even in very deep water. Ideal for fishing with live baits. Excellent value for money.

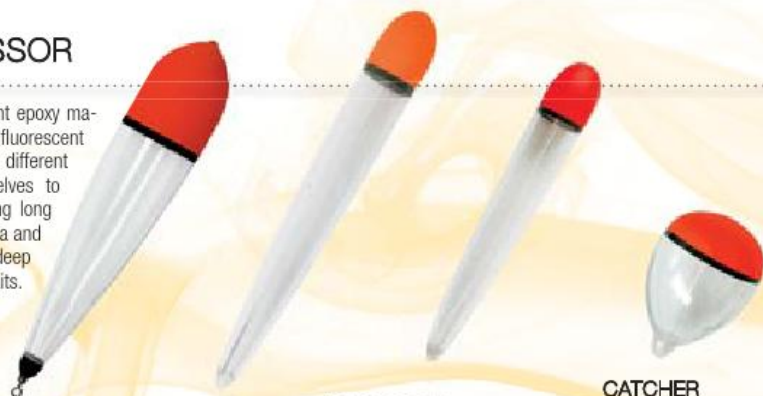

Code	Size
015-87-010	10.00
015-87-015	15.00
015-87-020	20.00
015-87-025	25.00
015-87-030	30.00
015-87-040	40.00

AGGRESSOR W/S

Code	Size
015-82-006	6.00
015-82-010	10.00
015-82-015	15.00
015-82-020	20.00
015-82-030	30.00
015-82-040	40.00

PIKE

Code	Size
015-75-006	6.00
015-75-010	10.00
015-75-015	15.00
015-75-020	20.00

AGGRESSOR

Code	Size
015-80-020	20.00
015-80-025	25.00
015-80-030	30.00
015-80-035	35.00

CATCHER

Code	Size
015-85-010	10.00
015-85-015	15.00
015-85-020	20.00
015-85-025	25.00
015-85-030	30.00

ANGLER PRO

Series of 4 models of floats conceived for and aimed at the hobby angler. Designed to solve and satisfy all strength and visibility requirements. The first two models are excellent for carp and eel fishing and are available in 10g size, while the other two are fantastic for perch and trout. The Perch Pro-Angler is available in 3g to 5g sizes and the one for trout in 2g and 3g. Unbeatable value for money.

Carpa



Anguilla



Persico



Trota



Code	011-00-010	011-00-050	011-00-060	011-00-080
Modello	Carpa	Anguilla	Persico	Trota
Size	10	10	3&5	3+2

ANGLER PLUS

Series of floats conceived for and aimed at the hobby angler. Designed to solve and satisfy all strength and visibility requirements. Suitable for many different kinds of fishing situations. Unbeatable value for money.

Code	Modello	Size
011-00-020	Slider	3
011-00-030	Sea Bream	3 & 7
011-00-040	Mackrell	4 & 8
011-00-070	Night	14



GROUNDBAITS

Trabucco produces its own groundbaits since 1986, by selecting the best ingredients on the worldwide markets, and by formulas created and developed on the banks of the rivers and competition venues of all Europe, and most of all, by the experience of a living legend like Roberto Trabucco.



Maurizio Fedeli

ULTIMATE GROUNDBAITS

All the Trabucco groundbaits are ready to use and don't require any additional ingredient in general sense, but of course every angler has his "secrets" and the wide range of ingredients and aromas of our range, can match every kind of demand and requirement. Our range is made by three series: the Team Master, recently developed in cooperation with the World Champion and Italian Champion Luigi Sorti; the Ultimate, issued by many years and rekon at international level, one of the best and most complete available in all market places.



Code	Description	Bag
PP 0010 30 01	Ultimate Supermix Carpa	1kg
PP 0010 11 00	Ultimate Carpe Tinche Rossa	1kg
PP 0010 11 01	Ultimate Carpe Tinche Gialla	1kg
PP 0010 50 01	Team Master Supreme	1kg
PP 0010 56 01	Ultimate Super Carassio Black	1kg
PP 1010 39 01	Super Bremes	1kg
060-45-010	Ultimate Canal Plus	1kg
060-45-020	Ultimate Canal Breme	1kg
PP 1010 41 01	Pro-Bremes	1kg
PP 1010 37 01	Gardon Competition	1kg
PP 1010 31 21	Ultimate Special Peschiera-Pozzolo	1kg
PP 0010 04 00	Ultimate Cavedani & Savette	1kg
PP 0010 01 00	Ultimate Alborella	900g
PP 0010 02 00	Ultimate Alborella Special	900g
PP 0010 10 00	Ultimate Special Match	1kg

GRAVEL



Code	Description	Bag
060-70-100	Grey Gravel	2kg
060-70-210	Red Gravel	2kg
060-70-220	Yellow Gravel	2kg



Gianluigi Sorti

XP 3000 GROUNDBAITS

New line of groundbait, made with selected, finely blended ingredients - extensively tested by our team before release onto the market. Each groundbait has been specially selected for use in our waters, and the handy size of 3kg allows for great savings.

Code	Description	Bag
060-05-100	XP 3000 Carpa Gialla	3kg
060-05-110	XP 3000 Carpa Rossa	3kg
060-05-300	XP 3000 Arno Pisa	3kg
060-05-400	XP 3000 Breme	3kg
060-05-410	XP 3000 Breme Black	3kg
060-05-200	XP 3000 Fiume Formaggio	3kg
060-05-500	XP 3000 Cavedani-Barbi Formaggio Rossa	3kg
060-05-600	Xp 3000 Carp Feeder	3kg
060-05-700	Xp 3000 Feeder Breme	3kg



Marco de Biase



XP 3000 SPECIAL SEA

Code	Description	Bag
060-06-100	XP 3000 Super Mix Bianca	3kg
060-06-200	XP 3000 Saraghi ed Occhiate	3kg
060-06-300	XP 3000 Super Mix Gamberetto	3kg

STICKY MAGGOT



Code	Description	Bag
140-20-300	Arabic Gum	500g
140-30-200	Team Master Colla Magica	1kg



Mario Baptista

XP 3000 LEAM

These are the special leams developed in cooperation with Team Ravanelli; successfully used during National and International matches.



Maurizio Fedeli



XP3000 Damp Leam is an extremely soft terre de somme with very fine granulometry, therefore ideal for the realization of the over damp leam or possibly sieved dry from the bag, to create the classical cloud to stain. Damp Leam XP 3000 is available both in classic brown color and in black. XP3000 River Leam is heavier than the previous ones, especially suitable to add weight to any groundbait or to be used in medium fast rivers with frequent baiting action (classic example Medelana venue).



Code	Description	Bag
062-16-100	Xp 3000 * Damp Leam	2kg
062-16-200	Xp 3000 * Black Damp Leam	2kg
062-16-300	Xp 3000 * River Leam	2kg

ADDITIVES AND INGREDIENTS

Trabucco offers a range of ingredients to create custom recipes, according everyone's preferences and needs. Every single ingredient has its specific own use and different



Code	Description	Proprietà	Bag
064-10-100	Collante X Fouillis	Highly Sticky	1kg
062-15-300	Terre D'etang	Sticky	2kg
062-15-100	Terre De Riviere Ocre	Sticky	3kg
PP 0030 22 00	Tourteau De Mais Gros	Disgregant/Slightly Sweet	1kg

organic qualities, that we have listed in the "Legenda" in order to make easier the correct use.

TORTEAU DE MAIS GROS

This component doesn't have any influence on nutritional properties of the groundbait, because oil has been drawn from the raw material, but only on mechanic behaviour of the mix. Due to its nature and texture, it has no binding power, so that Tourteau is added to quickly break up the groundbait balls when fishing midwater, both within pole range and long distance waggler action.

TERRE D'ETANG

With a slightly darker color and higher binding power than Terre De Somme/Damp Leam, it is therefore ideal to be added to your groundbait in deeper areas or with a moderate current. Also good for delivering a larger amounts of bait, especially when fishing with jokers.

TERRE DE RIVIERE OCREE

Leam with a moderate binding power and an excellent light brown color. To be added to groundbait, in the presence of moderate currents or deep venues. It is often over wetted and used to convey a large amount of bait or jokers when for fishing for bream in still waters.



METHOD & SPECIALIST MIX

These fantastic fishmeal groundbaits have been designed and tested without compromise by Roberto Trabucco in conjunction with all our best consultants, specifically for match and feeder anglers. They're produced using only the finest, natural and selected ingredients with a high protein content and the addition of attractors and stimulants. They're also produced in small batches to ensure a constant quality and the freshest groundbait.

Code	Description	Bag
060-02-000	Green Method Mix	1kg
060-02-100	Carp Method	1kg
060-02-200	Dark Expander	1kg
060-02-300	Super Natural	1kg

DARK EXPANDER

Dark colour and fine grain mix, it is particularly effective on bream, crucian and carp. The ingredients include fish meal with a lower nutritional value and minced expander pellets to ensure good dispersion even at lower temperatures.

SUPER NATURAL

This ground bait has been created for fishing fisheries, canals and rivers. The fine grain mix is made with selected ingredients such as fish meal and sweeties, the best combination if you need a ground bait able to stop the fish for a long time.

GREEN METHOD MIX

Brand new "Sweet Fishmeal", ground bait, i.e. based on fish meal but with the addition of sweet flavour ingredients. The colour is light green thanks to the Betaine Green. It has been designed especially for open-end and method feeder fishing for carp, crucian and big bream.

CARP METHOD

This high nutritional value ground bait has been created for fishing big carp and you should use it in Spring and Summer time. Great for use with open-end feeders, cage feeders or with flatbed method feeders. The main ingredient is the fish meal and so it is fast dissolving ground bait.



PELLET CARP BROWN

Pellet of new formula developed for the big carps and crucians. Very dark color and added with fish oil. It has been developed in cooperation with Trabucco Team World Club Champion.

Code	Description	Bag
060-50-700	Micro-Pellet Elite 1 mm	1kg
060-50-800	Pellet Carpe & Carassi 2 mm	1kg NEW
060-50-900	Pellet Carpe & Carassi 3 mm	1kg
060-55-000	Pellet Carp Halibut 4mm	1kg
060-55-100	Pellet Carp Halibut 6mm	1kg



Flatbed method feeder & flexy mould with pellet Carp Brown 3mm



The Method Feeder, together with the needful compendium Flexy Mould, can be easily used with soaked pellets. Even in this case the bait will result like the icing on the cake and fish cannot resist to eat it with a big gulp.



Balázs Németh

FEEDING ACCESSORIES

XPS CATAPULT



Code 141-71-100/5
Description XPS Catapult * 2.80 mm Pole



Code 141-71-200/5
Description XPS Catapult * 3.00 mm Pole Strong



Code 141-71-500/5
Description XPS Catapult * 5.00 mm Groundbait



Code 141-71-400/5
Description XPS Catapult * 4.50 mm Match Strong



Code 141-71-300/5
Description XPS Catapult * 4.00 mm Match



Gianluigi Sorti



SPARE LATEX ELASTIC

Code	Description	Colour	Ø mm
141-72-010/10	XPS Catapult Pole	Green	2.80
141-72-020/10	XPS Catapult Pole Strong	Red	3.00
141-72-030/10	XPS Catapult Match	Yellow	4.00
141-72-040/10	XPS Catapult Match Strong	Red	4.50
141-72-050/10	XPS Catapult Groundbait	Blue	5.00
141-72-060/10	XPS Catapult Groundbait Strong	Black	6.00



SPARE POUCHES

Code	Description
141-72-100/10	Mesh Pouch Small
141-72-200/10	Mesh Pouch Medium
141-72-300/10	Mesh Pouch Large



TOP RANGE CATAPULT

Code	Description
141-70-200/5	Top Range Groundbait



TRABUCCO BUCKETS

Code	Description
140-00-000	Trabucco Bucket 17 lt
140-00-005	Trabucco Bucket 12 lt

BUCKET
40 LT

Code	Description
140-00-010	Trabucco Bucket 40 litres

BUCKET'S LIDS

Code	Description
143-00-000	Lid for 17lt Bucket



GNT COVER

NEW



Code	Description
048-37-160	GNT Match Team Bucket Cover 17lt

RIDDLES



Code	Description
143-05-100	XPS Bucket Riddle Ø33cm/2mm

NEW



Code	Description
143-05-110	XPS Bucket Riddle Ø33cm/4mm

NEW



Code	Description
143-05-120	XPS Bucket Riddle Ø33cm/6mm

NEW



Code	Description
143-05-160	XPS Bucket Riddle Ø45cm/4mm

NEW



Code	Description
143-05-010	Large Mesh Riddle 40lt Bucket



MAGGOT BOX XPS

High quality bait boxes featuring transparent lids with holes, to store living baits. They feature a rubber edge to form a perfect seal.



Code	Description
111-15-100	XPS Maggot Box Blue 1lt

Code	Description
111-15-000	XPS Maggot Box Blue Double

Code	Description
111-15-200	XPS Maggot Box Blue 2.0lt

Code	Description
111-15-150	XPS Maggot Box Blue 1.5lt

OFFICIAL DOSER SET

Very useful set of bait's quantity dosers in liters, nowadays indispensable for competitions. They can be also used as simple bait box. The set is made by 5 dosers with capacity of 1,00 lt – 0,75 lt. – 0,50 lt. – 0,25 lt. e 1/8 lt.



Code	Description
111-35-100/6	Official Doser Set

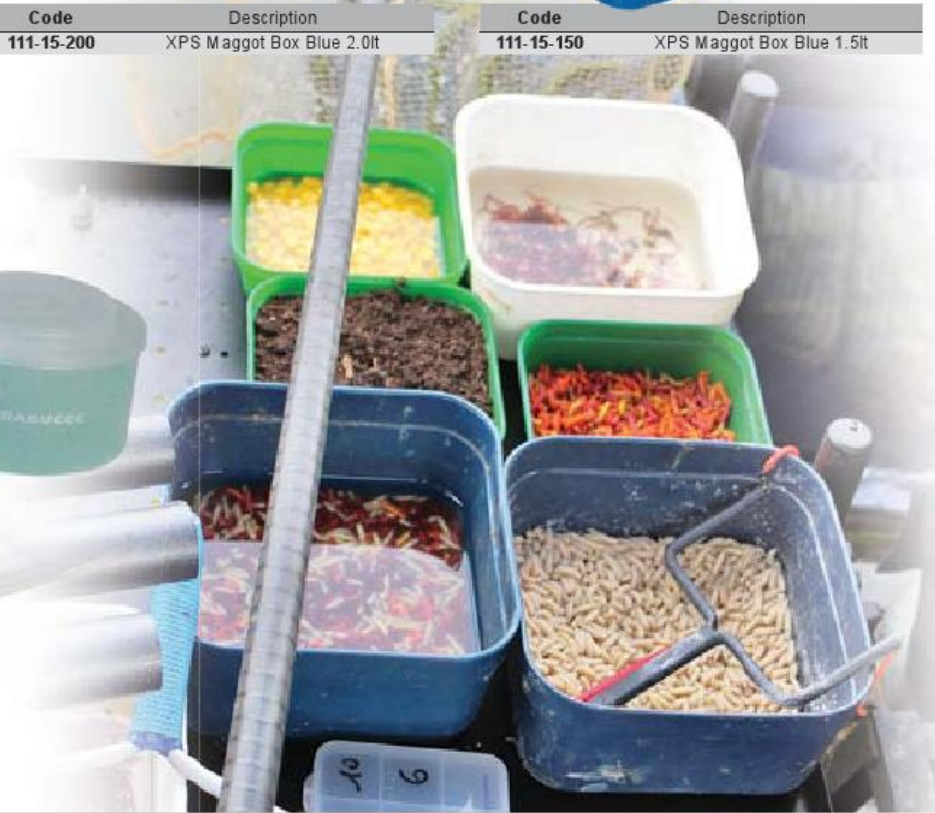

X3 BLADE SCISSOR

Stainless steel scissor razor shaped to chop everything. Suitable for worms, casters, corn...



Code	Description
101-40-010/10	X3 Blade Scissor

TRABUCCO BAIT BOX



Code	Description
111-21-025	Trabucco Bait Box 250g Blu
111-21-050	Trabucco Bait Box 500g Blu
111-21-100	Trabucco Bait Box 1000g Blu

Code	Description
111-20-025	Trabucco Bait Box 250g Green
111-20-050	Trabucco Bait Box 500g Green
111-20-100	Trabucco Bait Box 1000g Green

Code	Description
111-30-100	Trabucco Bait Box 4 Div. Green
111-31-100	Trabucco Bait Box 4 Div. Blu

TRABUCCO MESH POLE POT

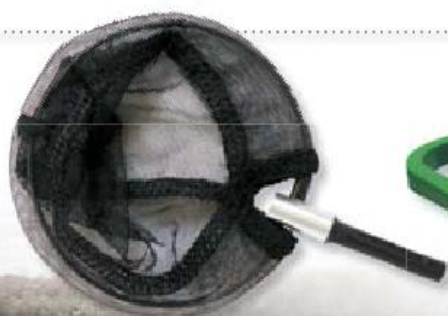

Code	Description
106-15-560/10	Mesh Pole Pot L
106-15-570/10	Mesh Pole Pot XL

BAIT WAITER



Code	Description
111-35-300	Bait Waiter

XPS EAZY FAST POLE POT



Code	Description
106-15-580/5	Xps Eazy Fast Pole Pot

TRABUCCO POLE POTS SET



Code	Description
106-15-510/10	Xps Pole Pots * Set 2pcs
106-15-550/10	Pole Pots * Set 3pcs

Stefano Bosi



Stefano Bosi



GNT COMPETITION

TAKE APART

Top of the range for the new season, the GNT Match Net is built with high modulus carbon, offering extreme stiffness and leghtness at the same time. The top section have been reinforced with additional carbon wraps and the screw is protected by shrink tube. The two butt sections comes with the graphics and allows it to be used both a the maximum length

and at 4m too. GNT also features the Advanced Slide Easy Finish as seen on the best long poles.

Code	Description	Length
080-83-540	GNT Match Net	5.40 m

ERION NETTER

TAKE APART

Put over handle built in HMR carbon and reinforced at points of greatest stress, offering a great stiffness and strong enough to suit all competitions, including commercial carp fisheries. It comes with two butt sections both featuring graphics and allowing it to be used at two lengths. It's also fitted with an additional screw on the second sections, this to remove the

top section and get a super stiff and strong handle.

Code	Description	Length
080-76-430	Erion Netter	4.30 m
080-76-540	Erion Netter	4.30 m

DREAM TEAM XPS NET

TAKE APART

Three sections net handle extremely light, rigid and balanced. Made in H.R. Carbon using a special reinforcements wich make this product almost unbreakable. Double Carbon reinforcements in the top end. Length 4.00m.

Code	Description	Length
080-82-400	Dream Team XPS Net	4.00 m

NEW SYNTIUM PRO

TAKE APART

Stiff, reactive and well balanced, thanks to the fast tapered profile. The structure in 4 sections with put-over joints is made from High Resistance carbon, and is completely protected by a crossed carbon yarn wich contrasts the ovalization during peaks of stress. The reduced closed length (113 cm only) enables to use the handle at different lengths below 4

metres, which is useful not only during pleasure sessions but also under some particular match conditions. Slide easy finish (ASEF) for comfortable use.

Code	Description	Length
080-99-400	Syntium Pro Net	4.00 m

LUCIFER MAX POWER

TAKE APART

Landing net handle entirely made in Carbon HR. Stiff, strong but lightweight, thanks to the two section design. Designed with the commercial carp fisheries in mind where mixed bag of both silvers and carp are the order of the day and where you can really appreciate the slim profile of the sections and its overall features. Of course it can be well employed on tra-

ditional matches where you need a reliable and stiff handle. The top thread is resistant to wear and corrosion.

Code	Description	Length
080-98-340	Lucifer Max Power	3.40 m



Mario Baptista

ANTRAX NET

TELE



This 5m long handle is suited to those situations where extra length is needed. Robust and reliable, it is perfect both for sea and fresh water use. The handle has reinforcements at the points of greatest stress and the internal thread is highly resistant to rust and saltwater.

Code	Description	Length
080-93-500	Antrax Net	5.00 m

PRECISION NET

TELE & TAKE APART



A wide range of net handles, constructed entirely in carbon composite Durawall HR. Excellent stiffness and strength, combined with lightness and good handling. The internal thread is highly resistant to rust and saltwater and is fixed to the blank with a sturdy rivet. Excellent value for money.

Code	Description	Length
080-91-300	Precision Net Tele	3.00 m
080-91-400	Precision Net Tele	4.00 m
080-92-300	Precision Net Take Apart	3.00 m
080-92-400	Precision Net Take Apart	2.00 m

REVENGE WRC POWERLAND

TELE



Telescopic handle available at 3 and 4 mts, entirely made of Powerfibre. It is really a versatile tool that can suit all conditions, from saltwater fishing to commercial fisheries. Provided of bronze thread and special grip coating on butt end.

Code	Description	Length
080-69-300	Revenge WRC Powerland	3.00 m
080-69-400	Revenge WRC Powerland	4.00 m

TELELAND

TELE



Telescopic handle available at 2,00 and 2,40 mts length. Made of Powerfibre it resolves all transport problems due the very short size of the sections, of just 30 cmts. Extremely reliable it is the best solution for all those fishing styles in which the angler must often change his fishing spot.

Code	Description	Length
080-85-200	Teleland	2.00 m
080-85-240	Teleland	2.40 m

NET HEAD & LANDING NET ADVANCED DESIGN

TX pro-net

Trabucco offers a wide range of landing net heads, developed and tested by the best Italian and European anglers. They are made of anodized aluminium, and offer a variety of shapes and mesh qualities. The hydrodynamic designs have been developed by the 20 years experience, and allow to manoeuvre the landing net head easily when following the fish approaching.

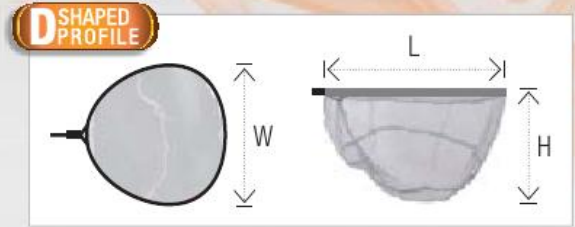

TX-3D MONO MESH

Available in three different sizes, these are all made by mono 6mm mesh to improve the lightness and offer less resistance in water. The D shape frame is made of anodized aluminium for added resistance, keeping the heads extremely light. The Eva fitted on the frame helps the buoyancy of the landing net, when approaching the fish and the handling when unhooking.



Code	Description	L	W	H
083-66-210	TX-3D Mono Mesh	45	40	23
083-66-220	TX-3D Mono Mesh	50	45	25
083-66-230	TX-3D Mono Mesh	55	50	25

TX-3D 2 MESH

They're built with a dual size mesh, large on the sides and a thick fish friendly material on the bottom. The D shape frame is made of anodized aluminium to increase resistance keeping the heads extremely light. Available in four different sizes.



Code	Description	L	W	H
083-66-010	TX-3D 2 Mesh	45	40	23
083-66-020	TX-3D 2 Mesh	50	45	25
083-66-030	TX-3D 2 Mesh	55	50	25
083-66-040	TX-3D 2 Mesh	60	55	28

TX-3D RUBBA MESH

Brand new net heads featuring the new latex coated mesh. Exceptionally strong, hydrodynamic but still very light as they don't absorb water. The D shaped aluminium frame gives more strength, fish friendly mesh perfect for commercial fisheries.



Code	Description	L	W	H
083-66-110	TX-3D Rubba Mesh	45	40	23
083-66-120	TX-3D Rubba Mesh	50	45	25
083-66-130	TX-3D Rubba Mesh	55	50	25
083-66-140	TX-3D Rubba Mesh	60	55	28

TX-MATCH PE

Brand new net heads fitted with fish friendly Pe mesh and D shaped aluminium frame. Definitely the lightest heads on the market, they're perfect for silver fish such as Bream and Roach. The depth allows to net the fish easier and quickly.

Code	Description	L	W	H
083-66-310	TX-MATCH PE 3mm	45	40	20
083-66-320	TX-MATCH PE 3mm	50	45	22



TX-MATCH MONO

Brand new net heads, available in two different sizes and fitted with Mono Mesh 6mm. The D shaped aluminium frame is strong and yet light. The depth allows to net the fish easier and quickly.



Code	Description	L	W	H
083-66-410	TX-MATCH Mono 6mm	45	40	20
083-66-420	TX-MATCH Mono 6mm	50	45	22

TR PRO NET

Two net heads designed with an increased depth to allow easily land those bonus fish. The TR Mono is made by a 20mm mono mesh, particularly suited to carp or sea fishing from docks. The PE mesh is totally "fish friendly", suited to both silver fish or carp and avoid the rig to tangle on the net for easy use.



MONO



PE

Code	Description	L	W	H
083-66-810	TR Pro Net Mono	45	52	40
083-66-820	TR Pro Net PE	38	50	35



TOP RANGE KEEPNET



Code	Description	Sect.	Size
083-60-800	Top Range Keepnet	2	60x35
083-60-810	Top Range Keepnet	3	80x35
083-86-820	Top Range Keepnet	4	110x40

TOP RANGE PRO LANDING NET

Great range of landing nets with aluminum anodized handle, 10mm PE mesh in black color e ultra-tough ABS locking system. The telescopic handle is available in two or three sections, allowing to reduce the closed length, while the octagonal profile offers a good strength without compromise the weight. Excellent value for money.

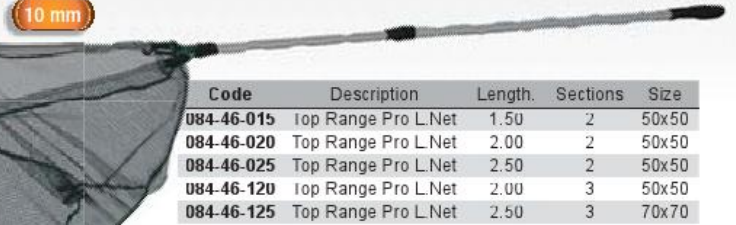

Code	Description	Length	Sections	Size
084-46-015	Top Range Pro LNet	1.50	2	50x50
084-46-020	Top Range Pro LNet	2.00	2	50x50
084-46-025	Top Range Pro LNet	2.50	2	50x50
084-46-120	Top Range Pro LNet	2.00	3	50x50
084-46-125	Top Range Pro LNet	2.50	3	70x70



AGGRESSOR LANDING NET

Range of landing nets entirely made in octagonal aluminium and fitted with a locking system for the 50x50 version or a high resistance nylon for the 70x70 version. Available in several lengths and with a choice of 6 or 15mm mesh.



Code	Description	Length	Mesh	Size
084-35-000	Aggressor Pro LNet	2.20	6 mm	70x70
084-35-100	Aggressor Pro LNet	2.50	6 mm	70x70
084-35-110	Aggressor Pro LNet	2.20	15 mm	70x70
084-35-120	Aggressor Pro LNet	2.50	15 mm	70x70
084-45-000	Aggressor Pro LNet	1.50	15 mm	50x50
084-45-010	Aggressor Pro LNet	2.00	15 mm	50x50
084-45-020	Aggressor Pro LNet	2.50	15 mm	50x50

Code	Description	Length	Mesh	Size
084-35-130	Aggressor LNet	1.20	6 mm	50x50
084-35-200	Aggressor LNet	2.00	6 mm	50x50
084-35-320	Aggressor LNet	1.20	15 mm	50x50
084-35-360	Aggressor LNet	1.60	15 mm	50x50

SCALE BAGS

Weighing bags.



Code	Description
083-60-415	TR Weight Scale Bag
083-60-410	TR Rubba Scale Bag

AGGRESSOR SEA

Series of landing nets made of anodized aluminium, available both telescopic or in one piece. The heads are locked to the handle with a sprung pin. The heads are offered in 3 different shapes and sizes. The mesh used is 10 and 15 mm. They have been developed for boat fishing, but especially the ones provided of telescopic handle can be used also for fresh water fishing.

Code	Description	Length	Mesh	Size
084-45-100	Aggressor Sea Oval	0.90	10 mm	65x75
084-45-200	Aggressor Sea "U"	2.00/2	15 mm	60x65
084-45-300	Aggressor Sea "V"	2.00/2	10 mm	58x55



NEW GNT MEGA PRO MATCH

- Fish Friendly PE mesh (Fishery approved)
- High Strength
- Reinforced and Weighted Rings
- Strong Tilt System
- Triple Seams



Code	Description	Size	Length
082-60-300	GNT Mega-Net Pro Recta Keepnet	50x40	3.00
082-60-350	GNT Mega-Net Pro Recta Keepnet	50x40	3.50
082-60-400	GNT Mega-Net Pro Recta Keepnet	50x40	4.00

NEW GNT MEGA MATCH

- High Quality PE/PVC mesh (Fishery approved)
- Hard Wearing
- Reinforced and Weighted Rings
- Strong Tilt System
- Triple Seams



Code	Description	Size	Length
082-65-300	GNT Mega-Net Match Recta Keepnet	50x40	3.00
082-65-350	GNT Mega-Net Match Recta Keepnet	50x40	3.50
082-65-400	GNT Mega-Net Match Recta Keepnet	50x40	4.00

GNT COMPETITION MATCH SILVER

- Fish Friendly PE Micromesh
- Reinforced Corners and Frame
- Reinforced and Weighted Rings
- Strong Tilt System
- Double Seams

Code	Description	Size	Length
082-08-350	Competition Match Silver Fish PE	50x40	3.50



GNT PRO-NET

- Reinforced PVC Micromesh
- Reinforced Corners and Frame
- Reinforced and Weighted Rings
- Strong Tilt System
- Double Seams



Code	Description	Size	Length
082-05-300	GNT-Pro Keepnet - Recta	50x40	3.00
082-05-350	GNT-Pro Keepnet - Recta	50x40	3.50
082-05-400	GNT-Pro Keepnet - Recta	50x40	4.00

Code	Description	Ø cm	Length
082-06-300	GNT-Pro Keepnet - Round	50	3.00
082-06-350	GNT-Pro Keepnet - Round	50	3.50
082-06-400	GNT-Pro Keepnet - Round	50	4.00

PRO-NET

- Micromesh
- Reinforced Corners and Frame
- Strong Tilt System
- Double Seams

Code	Description	Ø cm	Length
082-50-250	PRO-NET Round	50	2.50
082-50-300	PRO-NET Round	50	3.00

Code	Description	Size	Length
082-51-250	PRO-NET Recta	50x40	2.50

PRO-NET CARP

- Reinforced Micromesh
- Reinforced Corners and Frame
- Strong Tilt System
- Double Seams

Code	Description	Ø cm	Length
082-52-250	PRO-NET Carp Round	50	2.50
082-52-300	PRO-NET Carp Round	50	3.00

Code	Description	Size	Length
082-53-250	PRO-NET Carp Recta	50x40	2.50



TOP RANGE CARP



Code	Description	Ø cm	Length
086-40-150	Top Range Carp Round	50	1.50
086-40-200	Top Range Carp Round	50	2.00
086-40-250	Top Range Carp Round	50	2.50

XD MESH



Code	Description	Ø cm	Length
082-26-150	XD Mesh 3 mm Round	45	1.50
082-26-200	XD Mesh 3 mm Round	45	2.00
082-26-300	XD Mesh 3 mm Round	45	3.00

GNT TRABUCCO MATCH TEAM



MATCH TEAM
WATERPROOF
KEEPNET BAG

Code	Size
048-38-130	57x29x49cm

GENIUS WTP
KEEPNET BAG



Code	Size
048-39-010	45x45

GNT SL STATION

The GNT-SL STATION model has been designed to be lightweight and very stable. The frame features an exclusive minimalist but innovative style, it has an "X" shape that gives the whole structure a very strong and stiff touch, while keeping the weight as low as possible. Platform too has been totally re designed and does not share any moving part with the main station, so it is much more stable and safe for fishing action. Beside that it has been built in a non-slip material and it can be opened up to 44 cm, adapting at best with all the kinds of terrain. Round legs are 25 mm in diameter and are closer to the station, so every accessory you are going to add, it will be always at hand, improving the comfort and the speed of the fishing action. Stable, easy and quick to set up, the station has a lateral drawer positioned just under the seat, and a removable set of drawers with 3 compartments, one of them with central drawers, very easy to use while seated. It can be personalized using all the Genius modulus or the new accessories from the XPS series, adapting your station to your style of fishing.

SPECIFICATIONS

- Light alloy frame
- Sliding footplate with anti-slip system
- Removable base unit
- Telescopic legs with no-marking knobs
- Swivelling mud foot
- Padded pole gel seat
- Padded and adjustable shoulder strap
- Compatible with all the Genius Accessories



MODULAR SYSTEM



The newly designed sliding footplate offers a great stability and it's easy to place on all terrain.



The side spring button allows to easily remove the base unit.

Code	Description
116-00-650	Seatbox GNT-SL Station

NEW GNT X 925 STATION

New fishing station which has been engineered starting from the positive experience of GNT-SL model, which has had a great success amongst match anglers across whole Europe. The frame is actually a stunning mix of art and technology, with the fantastic aluminium "bridge" which keeps the seat up and distributes the load directly to the four main legs, as well as it signs the seatbox as one of the most beautiful ones ever seen in the market. The aggressive red frame is the only fashion detail, as everything else is oriented to extreme functionality, in line with the other products in the Trabucco range. The product is extremely light and rigid, but, at first sight, is the general compactness to strongly draw the attention. In fact, the seatbox body's height is limited to 48 cm, but the gap between footplate and seat can be quickly increased removing the lower set of drawers and placing it on top, just below the cushion. The sliding GNT footplate is confirmed also on this model, with the holes destined to provide a safe grip, as it's still unrivalled in term of adaptation to the ground profile.

SPECIFICATIONS

- Innovative tubular aluminium frame
- Six Ø 25 mm legs (four telescopic)
- Wide, tilting mud feet
- Sliding aluminium footplate
- Non-marking screws
- Padded pole gel seat
- Padded and adjustable shoulder strap
- Removable base unit, made of:
 - upper tray 4 cm deep
 - central unit with 2 front drawers
 - lower tray 4 cm deep
- Accessories' tray below seat, 4 cm deep
- Compatible with all Genius components and accessories

MODULAR SYSTEM

Both front drawers are equipped with dividers to practically and neatly store all the small tools.



The pole seat is super padded with gel and is nicely decorated by a red band.

Code	Description
116-00-660	Seatbox GNT X 925 Station



The fantastic bridge frame is a mix of art and technology which unmistakably signs the seatbox as one of the best ever.

GNT PRO STATION

GNT Station Pro is designed to meet the needs of the best European match anglers and Trabucco designed together with them. The lightweight and rigid monocoque frame is provided with three levels for easy positioning on any terrain. The legs uses the largely tested Fast-Lock System, a solution that those who have tried in previous versions will never leave and which ensures an easy and rapid setting, without tightening any screw. Other screws present on this station are under leveled, while the legs have a wide adjustable footprint to adapt to all land without bury themselves. The modules have also been designed to maximize the capacity, thus ensuring a large usable space inside them, while the front drawers offer the possibility to be divided using special dividers included. The comfort is guaranteed by a gel filled pillow and features the classic rigid cup for housing the rod; pillow's shape is also designed to support the angler's back during fishing action to maintain a correct posture. The platform also features large perforations to ensure anti-slip function. It is available a wide range of accessories making the GNT-Station Pro definitely the best on the market today: a stable and flexible workstation, very comfortable and light.



SPECIFICATIONS

- Powerfibre and 6015 Aluminium Monocoque
- Sliding Footplate with ant-slip System
- Removable base unit
- 2 front drawers with integrated dividers
- 3 rigs and accessories trays
- Telescopic legs with no-marking knobs
- Swivelling mud feet
- 3 built-in spirit levels
- Padded and adjustable shoulder strap
- Padded pole gel seat

MODULAR SYSTEM

Code	Description
116-00-580	Seatbox GNT Pro Station



All the hinges are made of durable ABS, to allow a complete seatbox customization thanks to the wide range of modules available.



Three spirit levels built into the seatbox frame help the correct positioning on all kind of terrain.



Both front drawers are equipped with dividers to practically and neatly store all the small tools.

NEW GNT X5 MATCH STATION

New seatbox which perfectly deserves the name of "match station", as it can be completed and super tuned by the addition of a virtually endless list of components and accessories of the Genius range. The frame is made from light and strong tubular aluminium, and telescopic leg's length is adjustable via a practical push lever. The locking system is quite interesting, as it's not due to normal screws, but made of clamp brakes whose grip is so smooth and safe at the same time. The wide rubber knobs allow

a quick setting up operation, even on steep banks. The footplate is sliding to enable partial opening in case a bulky stone is just in the middle of the fishing place. Beyond such advantage, of course this solution makes the seatbox compact for easy transport. All feet are mud proof and tilting around a ball head. GNT-X5 Station is definitely one of the most modern and attractive seatboxes available in the market, with a stunning quality/price ratio.



MODULAR SYSTEM

SPECIFICATIONS

- Tubular aluminium frame
- Six Ø 25 mm legs (four telescopic)
- Wide, tilting mud feet
- Sliding aluminium footplate
- Padded pole gel seat
- Accessorie's tray below seat, 7 cm deep
- The removable base unit is made of:
 - upper tray 4 cm deep
 - central unit with 2 front drawers
 - lower tray 4 cm deep
- Padded and adjustable shoulder strap
- Compatible with all Genius components and accessories

Code
116-00-670

Description
Seatbox GNT-X5 Match Station

NEW **GNT 725 STATION**

A new, excellent seatbox which is well placed within the great Trabucco range, thanks to the full compatibility with Genius components and accessories. The main specification is the adjustable seat height, which comes from the fact that the main body is linked to the legs independently from the footplate. Smooth and stable non-marking screws are standard also on this model: the wide rubber screw's head pushes firmly towards the leg, avoiding to damage it. The base unit include a 10 cm deep tray, which

is useful to store reels, catapults, wagglers and most bulky accessories. From the heart of the body, a sliding side tray is quite useful while fishing to hold the handy tools. The folding footplate is made of parallel bars to provide good grip also in case of muddy feet. The adjustable leg system is probably the easiest and safest to use among those now available in the market.

SPECIFICATIONS

- Tubular aluminium frame
- Six Ø 25 mm legs (four telescopic)
- Wide, tilting mud feet
- Folding aluminium footplate
- Adjustable seat height
- Padded pole seat
- Main body is made of:
 - upper tray 4 cm deep
 - central unit with 2 front drawers and 1 side tray
 - lower tray 10 cm deep
- Padded and adjustable shoulder strap
- Compatible with all Genius components and accessories.



Code	Description
116-00-680	Seatbox GNT 725 Station



GNT 3 XP

Completely made in aluminum and equipped with folding platform. It has a large drawer, located under the seat, two convenient front sliding drawers plus a side drawer that can hold all the accessories you use most frequently. The seat is made of anatomically foam and includes rod holders. The GNT-3XP can be completed with all the accessories in the Genius series to provide the ultimate in customization.

SPECIFICATIONS

- Light alloy frame
- Foldable footplate with anti-slip system
- Swivelling mud feet
- Padded pole gel seat
- Padded and adjustable shoulder strap
- Compatible with all the Genius Accessories

Code	Description
116-00-600	Seatbox GNT 3 XP





The main body is connected to the legs independently from footplate, so that the seat height is fully adjustable.



The adjustable locking footplate is quick and extremely safe.



The adjustable legs system is the quickest and safest now available in the market.

MODULAR SYSTEM

The seatbox can be adapted to personal needs through the wide range of Genius modules.



Alessandro Bruni

GNT 3

Modular basic version of the seatbox can be customized with the addition of the platform, modules and all the accessories available in the series Genius. Made of aluminum, has anatomical foam pillow, 2 large compartments to hold all the accessories, two comfortable sliding drawers plus a side drawer able to hold the material, which must

be easily found while remaining seated. Practical, basic, lightweight and ideal for the recreational anglers, both they fish in fresh or saltwater.

Code	Description
116-00-590	Seatbox GNT 3



SPECIFICATIONS

- Light alloy frame
- Swivelling mud feet
- Padded pole gel seat
- Padded and adjustable shoulder strap
- Compatible with all the Genius Accessories

MODULAR SYSTEM

NEW GNT CHAIR

ONLY 5.5 kg!

Wide, comfortable, strong and extremely compact for transport: it's the innovative aluminium framed fishing chair developed by Trabucco. Nowadays, this sort of products is recognized as "feeder chair", but why the other categories of anglers should stay away from it? After all, fishing is pleasure, therefore it should be lived at the very best, also from the comfort point of view. In the car, it takes a limited space: with back rest fully reclined and legs fixed to dedicated clips, this chair finds place even

in the smallest city cars. The walk to fishing spot is eased by a padded shoulder strap and EVA handle. The gel seat cushion hidden a wide accessory tray, 43x30 cm and 5 cm deep. The 58 cm long legs, with diameter of 25 mm and fitting tilt mud feet, enable to safely accommodate this chair on the steepest banks and accept all accessories of Genius or XPS Clamp-On range to build up an efficient and super tuned fishing station.

Code	Description
116-00-630	Seatbox GNT Chair



GENIUS XPS S3 COMPACT

Polyvalent seat box, light and easily transportable entirely built in aluminium. Under the shaped padded cushion is positioned a vain container with four fixed foot. A padded shoulder belt is furnished for the transport.

Code	Description
116-00-420	Genius XPS S3 Compact



SEATBOX GNT STOOL

Practical stool able to offer a fishing station in a while. All the legs are telescopic and fold underneath the seat. Compatible with all Genius modules.

Code	Description
116-00-620	Seatbox GNT Stool



FISHING SEATS

Code	Description
117-25-000	Fishing Seat
117-25-100	Fishing Seat with Drawer

INTEGRATED MODULES AND TRAYS

The genius range of accessories and components offers to keen match anglers the chance to integrate and customize all Trabucco seatboxes with interchangeable elements featuring high precision and reliability. Combining several modules and completing the lot with Genius Lid, the serious match anglers can create their own spare rig's container, to be always stored in the car when fishing conditions are unpredictable.



CUSHION & DRAWER TX RIVER



Code	Description
116-05-056	Cushion + Drawer TX River

2 FRONT DRAWERS



Code	Description
116-05-020	2 Front Drawers + Upper Room

BASIC MODULE



Code	Description
116-05-000	Basic Module

GNT PRO CUSHION



Code	Description
116-05-070	GNT Pro Cushion

CUSHION & DRAWER TX HARD



Code	Description
116-05-057	Cushion + Drawer TX Hard

SIDE DRAWER



Code	Description
116-05-010	Side Drawer + Upper Room

SPACER MODULE 30



Code	Description
116-05-040	Spacer Module 30 mm.

GNT PRO & SIDE DRAWER



Code	Description
116-05-075	GNT Pro Cushion & Side Drawer

CUSHION & DRAWER TX



Code	Description
116-05-058	Cushion + Drawer TX

SLIDING BASE MODULE



Code	Description
116-05-060	Sliding Base Module

GENIUS LIDS



Code	Description
116-05-030	GENIUS - Lid with handle
116-05-035	GENIUS - Lid without handle

NEW GNT MEGA SIDE TRAY



Code	Description	Size
116-10-350	GNT Mega Side Tray with Cover	45x65 cm

SIDE PLATFORM



Code	Description
116-10-005	Side Platform

SIDE PLATFORM W/LEGS



Code	Description
116-10-007	Side Platform W/Legs

XL SIDE TRAY



Code	Description
116-10-017	XL Side Tray

GENIUS PRO SIDE TRAY



Code	Description
116-10-320	Genius Pro Side Tray

MESH SIDE TRAY



Code	Description
116-10-015	Mesh Side Tray

BOWL SIDE TRAY



Code	Description
116-10-020	Bowl Side Tray

GENIUS BOWL



Code	Description
116-10-030	Genius Bowl

FRAME FOR BOWLS



Code	Description
116-10-025	Frame for Genius Bowls

TX FRONT ADJUSTABLE BAR



Code	Description
116-10-043	TX Front Adjustable Bar

TX FRONT BAR



Code	Description
116-10-042	TX Front Bar

T-FRONT BAR



Code	Description
116-10-040	T-Front Bar

EVA FRONT BAR



Code	Description
116-10-090	EVA Front Bar

WIND ARM



Code	Description
086-20-905	Wind Arm

M1 FRONT BAR/HANDLE



Code	Description
116-10-095	M1 Front Bar/Handle

XPS SPRAY BAR



FITTING ON:



Round Diam. 25mm & 30mm
Square Sez. 20mm

Code	Description
086-20-900	XPS Spray Bar

Roberto Trabucco

BUCKET HOLDER



Code	Description
116-10-000	Bucket Holder 17lt

ROUND BOWL HOLDER



Code	Description
116-10-003	Round Bowl Holder

GENIUS ROUND BOWL



Code	Description
116-10-035	Genius Round Bowl

GROUND BAIT BOWL W/HOOP



Code	Description
048-37-140	Groundbait Bowl w/Hoop
048-37-150	Groundbait Bowl w/Hoop XL

POWER UMBRELLA ARM



Code	Description
116-10-330	GENIUS Power Umbrella Arm

UMBRELLA ARM



Code	Description
116-10-080	Umbrella Arm
116-10-085	Umbrella Arm XL

RIPPLE BARS



Code	Description
116-10-250	Ripple Bar Long
116-10-260	Ripple Bar

SIDE ROD REST



Code	Description
116-10-093	Side Rod Rest

XPS UMBRELLA ARM



FITTING ON:
Round Diam. 25mm & 30mm
Square Sez. 20mm

Code	Description
086-20-910	XPS Umbrella Arm

KEEPNET ARM



Code	Description
116-10-055	Cross Arm
116-10-057	Cross Arm XL

DOUBLE BUTT REST



Code	Description
116-15-150	Genius Specialist Double Butt Rest

KEEPNET ARM



Code	Description
116-10-050	Keepnet Arm
116-10-052	Keepnet Arm Straight
116-10-053	Keepnet Arm Straight Long

UNIVERSAL CLAMP ACCESSORIES

UNIVERSAL CLAMP

A new range of aluminium arms, destined to customize the seatbox, which draws the attention for its chance to fit almost any leg without being inserted from top, but simply attached laterally.

Thanks to the innovative "Universal Clamp" system, the body of these accessories opens like a clamp, enabling to grab the leg on required position, in spite of any other accessory already fixed along the leg. Two sets of rubber adaptors, supplied with each single accessory, allows to fit round legs having 25 or 30 mm diameter, practically the whole world of modern seatboxes. If used without any adaptor, the clamp can fit square legs of 20x20 mm size. The practicality, safety and durability of these clever accessories is destined to make history and reinforce Trabucco image among competition specialist tackle field.



NEW XPS CLAMP-ON CROSS ARM



Code	Description	Size
086-20-840	XPS Clamp-On Cross Arm 90°	20 cm

NEW XPS CLAMP-ON POLE REST



Code	Description
086-20-880	XPS Clamp-On Pole Rest



Fabio Negri

NEW XPS CLAMP-ON KEEPNET ARM



Code	Description
086-20-870	XPS Clamp-On Keepnet Arm

NEW XPS CLAMP-ON FEEDER ARM



Code	Description	Size
086-20-820	XPS Clamp-On Feeder Arm 90°	50 cm
086-20-830	XPS Clamp-On Feeder Arm 90°	80 cm

BALLING ARMS



Code	Description	Pcs
116-10-075	Balling Arms	2

FRONT POLE REST W/ROLLER



Code	Description
116-10-060	Front Pole Rest With Roller

REAR POLE REST W/ROLLER



Code	Description
116-10-070	Rear Pole Rest With Roller

POLE REST XPS M



Code	Description
116-10-077	P/Roubaisienne XPS M

SIDE TOP-KIT REST



Code	Description
116-10-270	Side Top-Kit Rest

PRO TOP-KIT REST



Code	Description
116-10-300	Pro Top-Kit Rest

EVA POLE SOCK



Code	Description
106-15-705/10	EVA Pole Sock

T.R. TULIPOLE PEG



Code	Description
089-15-000	T.R. Tulipole Peg

QUICK ADAPTOR

Innovative adaptor with a spring lock anti-twist system, extremely strong and reliable. Designed for use with keep-nets, seatbox accessories, net heads and rod rest.



Code	Description
106-20-000	Quick Adaptor



Goran Radovic

LEG & MUD FOOT

Scodella per Piede



Code	Description
116-10-110	Fix Leg
116-10-120	Telescopic Leg
116-10-125	Telescopic Leg 800+400
116-10-111	Fix Leg Carbon
116-10-220	Mud Foot



55 cm

Fix Leg



55/90 cm

Telescopic Leg



89 cm

Tele Leg 800+400



55 cm

Fix Leg Carbon

LEG BRACKET



Code	Description
116-10-130	Leg Bracket

LEG SCREW KNOB



Code	Description
116-10-210	Leg Screw Knob

ACCESSORY SCREW



Code	Description
116-10-200	Accessory Screw

MODULE ORGANISER SET



Code	Description
116-05-045	Basic Module Organiser Set

PLASTIC DIV. FRONT DRAWER



Code	Description
116-10-245	Plastic Div. Front Drawer

SPARE HINGE



Code	Description
116-10-190	Spare Hinge

GRADIENT



Code	Description
116-10-230	Gradient

SHOULDER STRAP



Code	Description
116-10-100	Padded Carry Strap
119-00-010	Shoulder Strap - Mod. Lux

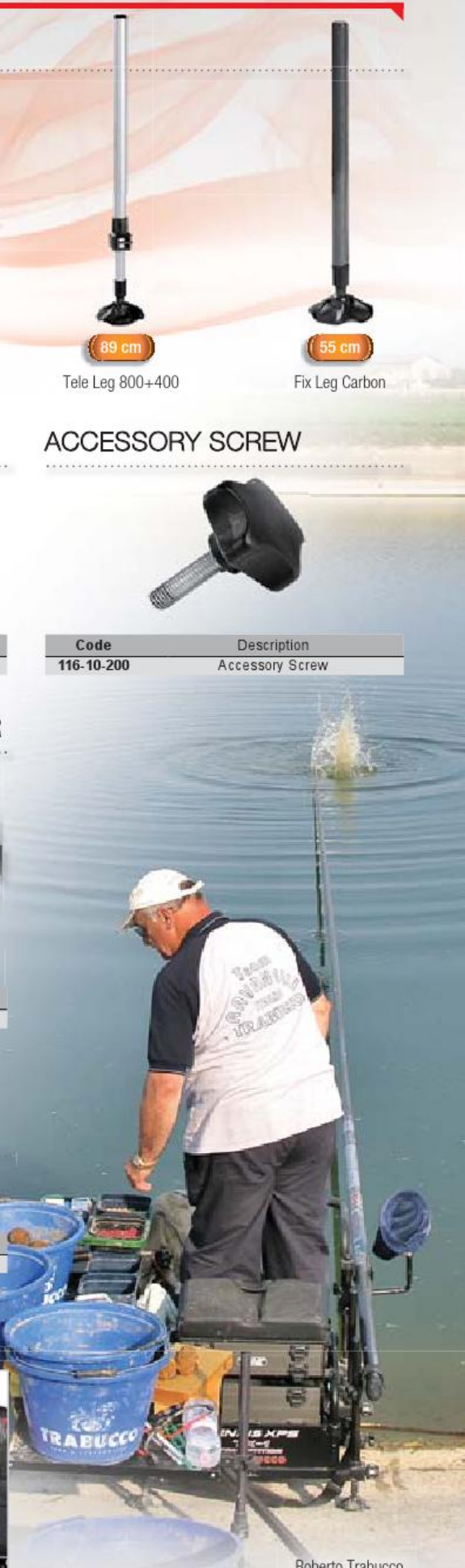

Roberto Trabucco

GENIUS PRO FEEDER ARM



Code	Description
116-10-047	Genius Feeder Telearm

NEW GENIUS FEEDER TELEARM



Code	Description
116-10-310	Genius Pro Feeder Arm

XPS FEEDER ARM



FITTING ON:
Round Diam. 25mm & 30mm
Square Sez. 20mm

Code	Description
086-20-800	XPS Feeder Arm 90° / 50

NEW XPS METHOD REST



Code	Description
086-22-050	XPS Method Rest

XPS FEEDER REST EVA



Code	Description
086-20-850/3	XPS Feeder Rest EVA

NEW XPS FEEDER REST METHOD RIPPLE



Code	Description
086-22-020/5	XPS Feeder Rest Method Ripple

XPS FEEDER REST RIBBED



Code	Description
086-20-860/3	XPS Feeder Rest Ribbed

XPS FEEDER REST FLAT RIPPLE



Code	Description	Size
086-22-000	XPS Feeder Rest Flat Ripple 30	L
086-22-010	XPS Feeder Rest Flat Ripple 45	XL

The Genius Specialist accessories has been designed to convert a normal chair into a true and complete fishing station. It is actually possible to add all the accessories both on squared or round frames of different diameters, while the regulation system allows to adjust the slant for your convenience.



GENIUS SPECIALIST FEEDER CHAIR

In the first year of life, the Genius Specialist Chair has got a fantastic success across the whole Europe, thanks to the high specifications but also thanks to the accessories that allow to further upgrade its comfort level. The unique slant regulation system perfectly suit the feeder expert's needs, while the chance to apply them to square or round structures widens their popularity.

Code	Description
117-25-200	Specialist Feeder Chair



GENIUS SPECIALIST FEEDER ARM

The Genius Specialist Feeder Arm is a telescopic arm that can host up to 2 rods. It must be used in combination with the Universal Adaptor.



Code	Description
116-15-130	Genius Specialist Feeder Arm

GENIUS SPECIALIST UNIVERSAL ADAPTOR

The Universal Adaptor will make every accessory of the Genius Specialist series suitable for your chair. Maximum customization.

Code	Description
116-15-100	Genius Specialist Universal Adaptor



GENIUS SPECIALIST ROUND & SQUARE BASSIN

The Genius Specialist Bassin are the perfect place to put your baits or groundbait. They can be adjusted at every angle for maximum comfort.



Code	Description
116-15-120	Round Bassin

Code	Description
116-15-110	Square Bassin

NEW GNT MEGA ROLLER 903XXL

WITH BAG



! GNT Mega Roller legs must always be opened and closed holding two of them together. In this way, the operation will be quick and safe.

Three sections telescopic legs.

Code	Description	Size
086-21-100	GNT Mega Roller 903XXL	90 cm

NEW GNT MEGA ROLLER 502XL

WITH BAG



Foldable heads for easy transport.

Code	Description	Size
086-21-000	GNT Mega Roller 502XL	50 cm

NEW XPS 4 LEGS ROLLER

WITH BAG



Code	Description	Size
086-20-180	XPS 4 Legs Roller	60 cm

NEW XPS EASY FOLD V-ROLLER



Code	Description
086-20-190	XPS Easy Fold V-Roller

ROLLERS

Code	Description
088-40-302	Mini Folding Roller

Code	Description
088-40-350	Pro-Roller V 4BB



TOP RANGE ROLLER 4 LEGS

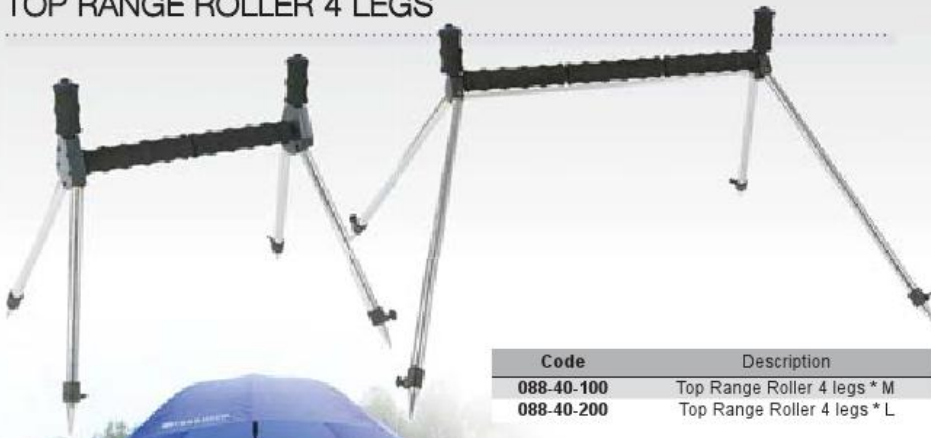

Code	Description
088-40-100	Top Range Roller 4 legs * M
088-40-200	Top Range Roller 4 legs * L

TOP RANGE POLE ROLLER FOLDING



Marco Busani



WITH BAG

Code	Description
088-40-000	Top Range Pole Roller Folding

TOP RANGE TRIPOD ROLLER



WITH BAG

Code	Description
086-20-200	Top Range Tripod Roller

XPS TRIPOD ROLLER



Code	Description
086-20-160	Xps Tripod Roller

HI VIZ TRIPOD ROLLER



Code	Description
086-20-100	Hi VIZ Tripod Roller

TX TRIPOD POLE ROLLER



Code	Description
086-20-110	TX Tripod Pole Roller

NEW GNT MEGA KIT REST

WITH BAG



Designed for the demanding angler, these fantastic aluminium framed rod rests can be set up and fold down in a second, thanks to the tilt leg system. Twelve places with windproof EVA slots and three sections telescopic legs. Waterproof bag included.

GNT Mega Rest legs must always be opened and closed holding two of them together. In this way, the operation will be quick and safe.

Code	Description
086-21-200	GNT Mega Kit - Front Rest
086-21-300	GNT Mega Kit - Back Rest



Gianluigi Sorti

XPS 10 KITS REST

TOP RANGE TRIPOD REST



Code	Description
086-20-700	XPS 10 Kits Rest Front

Code	Description
086-20-750	XPS 10 Kits Rest Rear

Code	Description
086-20-301	Top Range Tripod Rest F.SIS

HI VIZ POLE REST

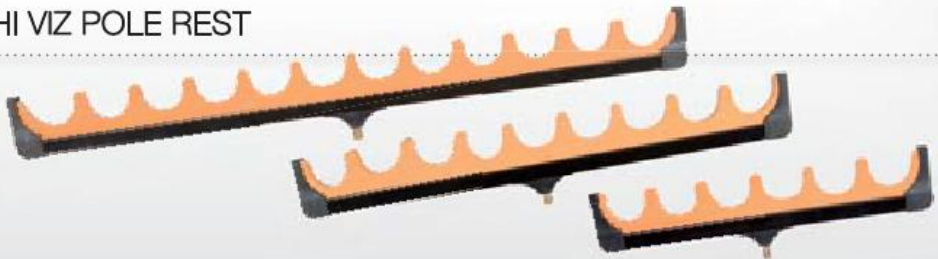

Code	Description
086-20-420	HI VIZ Pole Rest 6 Rods
086-20-430	HI VIZ Pole Rest 9 Rods
086-20-440	HI VIZ Pole Rest 12 Rods

UMBRELLAS & BANKSTICKS

Sun, wind and rain are the elements which mostly disturb pleasure and efficacy of fishing action, but the solution is available under several form. Along with traditional models, now Trabucco offers small

sized umbrellas, specifically designed for bait and groundbait, as well as the innovative versions featuring light grey colour fabric, which reflects sun rays to keep a lower temperature inside of the shelter.

UMBRELLA ROUND PVC



Code	Description	Size
108-50-300	Umbrella Round PVC	250 cm

UMBRELLA ROUND MATCH



Code	Description	Size
108-52-100	Umbrella Round Match	250 cm

UMBRELLA SQUARE MATCH



Code	Description	Size
108-52-000	Umbrella Square Match	150 cm

UMBRELLA MATCH PU



Code	Description	Size
108-50-410	Umbrella Match PU	250 cm

UMBRELLA MATCH BAIT



Code	Description	Size
108-50-501	Umbrella Match Bait PU	60 cm

UMBRELLA HALF TENT PU



Code	Description	Size
108-52-300	Umbrella 250PU/Half Tent	250 cm

BANKSTICKS



ALUMINUM

Code	Description	Ø / Length (mm)
V2 0010 01 00	Fix Bankstick	9x750
088-55-500	Top Range Screw End	22x760
088-55-510	Top Range Screw End	22x1000
088-55-200	Top Range Bank Stick	19 x 760
088-55-300	Top Range Bank Stick	22 x 760
088-55-400	Top Range Bank Stick	22 x 1200

XPS FLUORO POWER LATEX

Super silicon treated solid elastic, supple and forgiving on the strike and produced by pure latex. The innovative extruding process allows to obtain a perfectly round profile, with an high and progressive stretch factor and it retracts faster inside the pole. Supplied in 10 or 7.5m spools according to the size, produced in high visibility colors and ultra-resistant to wear, it's the first choice of the Ravanelli Team Trabucco.

FEATURES:

- 100% Pure Latex
- Super Smooth with Slip Silicon treatment
- Highly visible fluorescent colours
- High factor stretch and dual-phase action
- Retract faster inside the pole
- Produced to be more forgiving on the strike
- Supplied in 10m or 7.5m spools
- Available in 8 sizes to cover all fishing styles

Code	Description	Length	Ø mm	Size
102-02-080/10	XPS Fluoro Power Latex	10 m	0.8	4
102-02-090/10	XPS Fluoro Power Latex	10 m	0.9	5
102-02-100/10	XPS Fluoro Power Latex	10 m	1.0	6
102-02-120/10	XPS Fluoro Power Latex	10 m	1.2	8
102-02-140/10	XPS Fluoro Power Latex	10 m	1.4	10
102-02-160/10	XPS Fluoro Power Latex	7.5 m	1.6	12
102-02-180/10	XPS Fluoro Power Latex	7.5 m	1.8	14
102-02-210/10	XPS Fluoro Power Latex	7.5 m	2.1	16



XPS

XPS POWER CORE HOLLOW ELASTIC

Manufactured from the very highest quality raw materials available and to the strictest quality standards, using the twin core hollow system. The core is strong and durable, making it more powerful, while the outer layer increase smoothness. Power Core not only stretches further than any other elastic on the market, but also retracts faster, which is without doubt a massive benefit on landing bonus fish faster. Now available also in the 1.2 and 1.5mm diameters, supplied in 4m pack, ideal to elasticated up to two top kit and to get the XPS Power Core outstanding performances also when fishing for silver. Available in 8 sizes to cover any pole fishing situation.

FEATURES:

- Double Core Latex
- Smoother Surface
- High Stretch
- Retracts Faster
- Dualphase Action
- Self-Lubricated

Code	Description	Length	Ø mm	Size
102-05-120/5	XPS Pwr Core Hollow Elastic	4 m	1.2	3-5
102-05-150/5	XPS Pwr Core Hollow Elastic	4 m	1.5	4-6
102-05-180/5	XPS Pwr Core Hollow Elastic	3 m	1.8	5-8
102-05-210/5	XPS Pwr Core Hollow Elastic	3 m	2.1	6-10
102-05-230/5	XPS Pwr Core Hollow Elastic	3 m	2.3	10-14
102-05-250/5	XPS Pwr Core Hollow Elastic	3 m	2.5	12-16
102-05-270/5	XPS Pwr Core Hollow Elastic	3 m	2.7	14-18
102-05-300/5	XPS Pwr Core Hollow Elastic	3 m	3.0	16-20



XPS CARP HYPER POWER

This new elastic has been created using only the purest raw materials and its diameter is computer checked along its whole length, to grant all the anglers the best performance and reliability even for the most extreme fishing techniques. The latex compound is extremely stretchable and so has a huge power reserve, still keeping a progressive action. This feature is the secret to easily win arsh battles with big fishes. The surface of the elastic has been treated with silicon, to get a super smooth feeling and reduce friction.

FEATURES:

- 100% Hyper Stretch Pure Latex
- Super Smooth with Slip Silicon treatment
- Highly visible fluorescent colours
- High factor stretch and dual-phase action
- Retract faster inside the pole
- Produced to be more forgiving on the strike
- Supplied in 10m or 7.5m spools

Code	Description	Length	Ø mm
102-03-220/10	XPS Carp Hyper Power	5 m	2.2
102-03-240/10	XPS Carp Hyper Power	5 m	2.4
102-03-260/10	XPS Carp Hyper Power	5 m	2.6

Goran Radovic

XPS DOUBLE FLUORO LATEX

This high quality latex elastic has been developed to make the threading of the popular Double Elastic easier. You can now elastic your top kit as you did with a single strand and once threaded the Double Fluoro can be easily separated into a perfect Double Elastic System. Comes in 6m spools to elasticate up to two top 3.

FEATURES:

- 100% pure latex
- Developed to make elastication easy
- Strands can be separated once fitted
- Produced to be more forgiving on the strike
- Highly visible fluorescent colours
- Super smooth
- Supplied in 6 metre spools
- Available in 5 sizes to cover all fishing styles



Code	Description	Length	Ø mm
102-00-070/5	XPS Double Fluoro Latex	6 m	0.7 x 2
102-00-080/5	XPS Double Fluoro Latex	6 m	0.8 x 2
102-00-090/5	XPS Double Fluoro Latex	6 m	0.9 x 2
102-00-100/5	XPS Double Fluoro Latex	6 m	1.0 x 2
102-00-120/5	XPS Double Fluoro Latex	6 m	1.2 x 2

LUCIFER POLE LATEX

STRETCH 700%

FEATURES:

- 100% Latex Base
- Special Smooth
- UV resistant
- Silicon Coated
- Abrasion Resistant

Code	Description	Length	Ø mm	Size
101-92-080/10	Lucifer Pole Latex	7.5 m	0.8	4
101-92-090/10	Lucifer Pole Latex	7.5 m	0.9	5
101-92-100/10	Lucifer Pole Latex	7.5 m	1.0	6
101-92-110/10	Lucifer Pole Latex	7.5 m	1.1	7
101-92-120/10	Lucifer Pole Latex	7.5 m	1.2	8
101-92-140/10	Lucifer Pole Latex	7.5 m	1.4	10
101-92-160/10	Lucifer Pole Latex	7.5 m	1.6	12



Maurizio Fedeli

XPS COMPETITION PTFE BUSH

PTFE 100%



Code	Description	Bore Ø mm	Pcs
102-07-100/10	Internal	2.30	2
102-07-110/10	Internal	2.60	2
102-07-120/10	Internal	2.80	2
102-07-130/10	Internal	3.00	2
102-07-140/10	Internal	3.20	2
102-07-150/10	Wide Bore	5.00	2

VESPE PTFE BUSHES

PTFE 100%



Internal External

Code	Description	Bore Ø mm
103-05-001/10	External 1	1.4
103-05-002/10	External 2	1.7
103-05-003/10	External 3	2.1
103-05-004/10	External 4	2.3
103-07-001/10	External Big Bore	4.0
103-07-002/10	External Big Bore	4.5
103-06-001/10	Internal 1	1.7
103-06-005/10	Internal 5	3.2
103-06-007/10	Internal 7	4.5
103-06-008/10	Internal 8	5.2

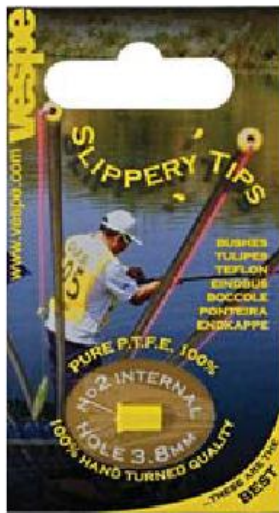

VESPE COMPLETE ELASTICATION SYSTEM



Code	Description	Size
103-30-010/10	Vespe Complete Set	1 Micro
103-30-020/10	Vespe Complete Set	1 Canal
103-30-030/10	Vespe Complete Set	2 Canal
103-35-010/10	Spare Cones 2pcs	Micro
103-35-020/10	Spare Cones 2pcs	Canal
103-35-030/10	Spare Winder 2pcs	25mm
103-35-040/10	Spare Winder 2pcs	50mm
103-40-001/10	Tip Connector	Canal
103-40-002/10	Tip Connector	Carp

TM CONE BUNG



Code	Description	Size
103-90-100/10	TM Cone Bung	S
103-90-200/10	TM Cone Bung	L

WINDER BUNG



Code	Description	Size
103-80-100/10	TM Winder Bung	S
103-80-200/10	TM Winder Bung	L

TEAM MASTER BUNG EXTRACTOR

Made from high quality plastic. The set includes cone, extractor and winder.



Code	Description	Size
103-75-100/5	TM Bung Extractor	S
103-75-200/5	TM Bung Extractor	L

ELASTIC PROTECTOR

Useful bit to protect the elastic of the pole while it is set down. Produced in soft material.



Code	Description	Pcs
103-76-000/10	TM Elastic Protector	5

POLE ELASTIC THREADER



3m

Code	Description
115-30-320/10	Pole Elastic Threader
115-30-310/10	Diamond Steel Wire 1M

DACRON CONNECTORS

Trabucco Dacron connectors have been specifically developed to provide a neat link between your elastic and your rig. The Dacron holds your rig away from your pole tip whilst the purpose designed bead makes sure the Dacron points forwards to keep tangles to an absolute minimum. Available in two sizes to suit most popular elastic sizes.



Code	Size
102-07-000/10	Small
102-07-010/10	Large

VESPE INTERMEDIATES

Specially designed flexible internal guides made from 100% pure PTFE will "lift" your elastic off the side wall stopping DRAG and FRICTION ...so no matter where your fish runs it's the smoothest elasticsation system ever!



Code	Description	Bore Ø mm
103-08-001/10	Intermediates	2.3



XPS PULLA BUNG

Manufactured from lightweight plastic the XPS Pulla Bung can be used as a regular pole bung, but enables the angler to pull the elastic tighter after unshipping. The advantage is that you can use lighter elastics, but tighten it for netting if you hook a bonus fish. This means

you don't need to play and net big carp on long top kit, which leads to better control, faster netting and less pole breakages.

Code	Description
102-40-000/10	Xps Pulla Bung

COMPETITION X-FINE SILICONE

High performance, ultra fine silicone tube. Designed to fit the finest wire and carbon pole stems. Colour coded for easy recognition.

COMPETITION X-FINE

Code	Description	Ø	Colour
100-16-030/10	X-Fine Silicone	0.3mm/50cm	Red
100-16-040/10	X-Fine Silicone	0.4mm/50cm	Blue
100-16-050/10	X-Fine Silicone	0.5mm/50cm	Gold
100-16-060/10	X-Fine Silicone	0.6mm/50cm	Orange
100-16-080/10	X-Fine Silicone	0.8mm/50cm	Yellow
100-16-100/10	X-Fine Silicone	1.0mm/50cm	Grey



TEAM MASTER FLOAT RINGS



Code	Description	Ø mm
103-15-200	TM.Float Ring Medium	0.7-4.0
103-15-300	TM.Float Ring + Tube Mix	/

EASY LOOP TYER

Perfect loops the same size every time. The loop tyer provides two sizes of loop to suit your fishing situation.



Code	Description
101-57-100/10	Easy Loop Tyer

XPS HOOK TYER



Code	Description
101-30-100/10	Xps Hook Tyer

COMPETITION HOLLOW ANTENNA

New series of hollow antenna perfect to face any situation where you need to customize your floats. Especially during competition, it can happen that you need to change quickly the antenna depending on fishing conditions, this product is with you need. This COMPETITION series are made using high visibility painting, which makes possible to detect even the most delicate bite in any light condition.

Code	Description	Ø mm	Length
001-05-210/10	Antenna Comp.	1.0	50 mm
001-05-212/10	Antenna Comp.	1.2	50 mm
001-05-215/10	Antenna Comp.	1.5	50 mm
001-05-217/10	Antenna Comp.	1.7	55 mm
001-05-220/10	Antenna Comp.	2.0	55 mm
001-05-222/10	Antenna Comp.	2.2	55 mm
001-05-225/10	Antenna Comp.	2.5	56 mm
001-05-230/10	Antenna Comp.	3.0	60 mm
001-05-235/10	Antenna Comp.	3.5	60 mm
001-05-240/10	Antenna Comp.	4.0	60 mm
001-05-245/10	Antenna Comp.	4.5	60 mm
001-05-250/10	Antenna Comp.	5.0	60 mm



Gianni Fenu



SLIDER CONNECTOR



101-55-5(10-20-30)

101-55-5(40-50)



Code	Description	Size	Pcs
101-55-510/10	Slider Connector PTFE	SS	5
101-55-520/10	Slider Connector PTFE	S	5
101-55-530/10	Slider Connector PTFE	M	5
101-55-540/10	Slider Connector Metal	S	5
101-55-550/10	Slider Connector Metal	M	5

STRONG SLIDER CONNECTOR FEEDER



5pcs

Code	Description	Size
101-55-600/10	Strong Slider Connect. Fdr	S
101-55-610/10	Strong Slider Connect. Fdr	M

FIX WAGGLER CONNECTOR



Code	Description	Pcs
101-55-570/10	Fix Waggler Connector	3

EASY STOP CONNECTOR



Code	Description	Pcs
101-55-560/10	Easy Stop Connector	5

DISGORGERS



Code	Description
103-76-100/10	TM Disgorger Elite L
103-76-150/10	TM Disgorger Elite S
VV 0010 33 01/20	Disgorger Stonfo
VV 0010 33 07/10	Disgorger Stonfo Match

ROD SPACERS



Code	Description	Pcs
104-30-100/10	TM Rod Spacers	2

SCREW TUBES



Code	Description
110-30-100/6	Telescopic tubes

TEAM MASTER FLOAT WEIGHTS

Useful float attachment to increase the loading of your wagglers. Suitable for the World Class and XD series.



Code	Description	Wt	Pcs
101-55-100/10	Pesi in Ottone per gallegg.	2.50	2
101-55-200/10	Pesi in Ottone per gallegg.	4.00	2
101-55-300/10	Pesi in Alluminio per gallegg.	2.50	2
101-55-400/10	Pesi in Alluminio per gallegg.	4.00	2

WEED CUTTER



Code	Description
089-50-000/10	Weed Cutter

WINDER ANCHOR



Code	Description
104-20-100/10	Winder Anchor 10pcs

NEOPRENE ROD BANDS



Code	Description	Pcs
104-40-300/10	Neoprene Rod Bands	2

HOOK HOLDER PRO

Code	Description	Length
103-65-200	Hooks Holder Pro	25 cm
103-65-210	Hooks Holder Pro	38 cm



HOOK HOLDER

Code	Description	Length
103-65-030	Hooks Holder	30 cm
103-65-035	Hooks Holder	35 cm
103-65-045	Hooks Holder	40 cm



XPS HOOK BOXES



Code	Description	Size
103-55-120	XPS Hook Box	20 cm
103-55-125	XPS Hook Box	25 cm
103-55-130	XPS Hook Box	30 cm
103-55-135	XPS Hook Box	35 cm
103-55-140	XPS Hook Box	40 cm

MAGNETIC HOOK BOX

Code	Description
103-65-100	Magnetic Hooks Box

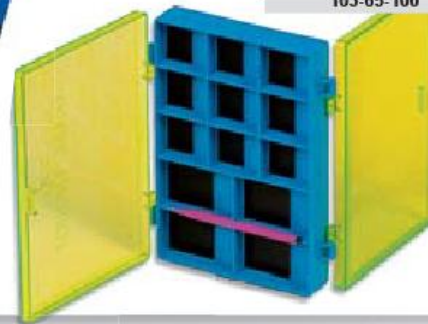

XPS FLUO WINDERS

XPS FLUO WINDERS are extremely strong, maintaining your rigs in perfect conditions. The tapered hook retaining system can accommodate even the smallest of the hooks. XPS Winder are designed to fit on all Genius seatboxes.

Code	Description	Colour	Pcs
103-95-100	XPS Fluo Winder	Fluo Red	8
103-95-110	XPS Fluo Winder	Fluo Yellow	8
103-95-120	XPS Fluo Winder	Fluo Green	8

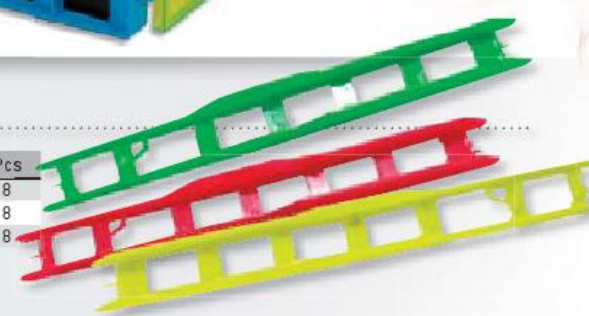

WINDERS



Code	Description	Size
V7 0009 03 00	Winder Narrow	18 cm
V7 0009 04 00	Winder Narrow	20 cm
V7 0009 05 00	Winder Narrow	22 cm
V7 0009 07 02	Winder Narrow	25 cm
V7 0009 06 00	Winder Large	20 cm
V7 0009 07 00	Winder Large	22 cm
V7 0009 07 01	Winder Large	25 cm
V7 0009 08 00	Winder Large	30 cm
V7 0009 08 01	Winder Maxi	30 cm
V7 0009 09 00	Winder Maxi	35 cm

WINDERS MASTER



Code	Description	Size	Colour
116-60-110	Wind. Master Large	250*25	Red
116-60-120	Wind. Master Large	250*25	Blue
116-60-130	Wind. Master Large	250*25	Black
116-60-140	Wind. Master Narrow	250*18	Red
116-60-150	Wind. Master Narrow	250*18	Blue
116-60-160	Wind. Master Narrow	250*18	Black

SHOT TESTING TUBE

Code	Description
115-30-200	Shot Testing Tube

110cmx8cm



MATCH SHOT & SINKERS

MASCOTTE MATCH SHOT



Code	Description
092-10-200/10	Mascotte Match Shot 06-12
092-10-300/10	Mascotte Match Shot 05-2/0

NEXIA LEAD BOX



Code	Description	Weight
090-55-000/10	Nexia Lead Box	80.0g
090-55-100/12	Nexia Lead Box	120.0g

DISPENSER TEAM MASTER PRO-SHOT



Code	Size	Weight
092-06-080/30	8/0	2.000 g
092-06-070/30	7/0	1.500 g
092-06-060/30	6/0	0.960 g
092-06-050/30	5/0	0.790 g
092-06-040/30	4/0	0.680 g
092-06-030/30	3/0	0.470 g
092-06-020/30	2/0	0.420 g
092-05-000/30	0	0.390 g
092-05-001/30	1	0.295 g
092-05-002/30	2	0.271 g
092-05-003/30	3	0.221 g
092-05-004/30	4	0.177 g
092-05-005/30	5	0.135 g
092-05-006/30	6	0.112 g
092-05-007/30	7	0.088 g
092-05-008/30	8	0.070 g
092-05-009/30	9	0.055 g
092-05-010/30	10	0.040 g
092-05-011/30	11	0.035 g
092-05-012/30	12	0.022 g
092-05-013/30	13	0.020 g

MASCOTTE MATCH SHOT



Code	Description
092-10-400/10	Mascotte Match Shot 0-8/0

SPLIT SHOT DISPENSER



Code	Size
090-55-400/10	0.10-0.20-0.40-0.60-0.80-1.00-1.20

MASCOTTE TEAM MASTER PRO-SHOT



Code	Description
090-50-100/10	TM Pro-Shot 8 sez-0/7
090-50-200/10	TM Pro-Shot 8 sez-6/13

MASCOTTE TRABUCCO



Code	Description
PB 0010 12 00/10	Mascotte Trabucco Small
PB 0010 13 00/10	Mascotte Trabucco Large

MASCOTTE TFL COATED SHOT

TFL COATED



Code	Description
092-10-000/10	Mascotte I+L Shot 00/06
092-10-100/10	Mascotte TFL Shot 05/11

TEAM MASTER
OLIVETTES

TRABUCCO
TFL SPLIT SHOT

TFL COATED



Code	Size	Weight
092-00-000/30	0	0.390 g
092-00-001/30	1	0.295 g
092-00-002/30	2	0.271 g
092-00-003/30	3	0.221 g
092-00-004/30	4	0.177g
092-00-005/30	5	0.135 g
092-00-006/30	6	0.112 g
092-00-007/30	7	0.088 g
092-00-008/30	8	0.070 g
092-00-009/30	9	0.055 g
092-00-010/30	10	0.040 g
092-00-011/30	11	0.035 g

OLIVETTES
NON-TOXIC

NO TOXIC



Code	Weight	Pcs
093-05-010/10	1.0 g	5
093-05-015/10	1.5 g	5
093-05-020/10	2.0 g	5
093-05-025/10	2.5 g	5
093-05-030/10	3.0 g	5
093-05-040/10	4.0 g	5
093-05-050/10	5.0 g	5
093-05-060/10	6.0 g	5
093-05-080/10	8.0 g	5
093-05-100/10	10.0 g	5



Code	Weight	Pcs
090-30-005/10	0.50 g	5
090-30-007/10	0.75 g	5
090-30-010/10	1.00 g	5
090-30-012/10	1.25 g	5
090-30-015/10	1.50 g	5
090-30-017/10	1.75 g	5
090-30-020/10	2.00 g	5
090-30-025/10	2.50 g	5
090-30-030/10	3.00 g	5
090-30-035/10	3.50 g	5
090-30-040/10	4.00 g	5
090-30-045/10	4.50 g	5
090-30-050/10	5.00 g	5
090-30-060/10	6.00 g	5
090-30-080/10	8.00 g	5
090-30-100/10	10.00 g	5
090-30-120/10	12.00 g	3
090-30-150/10	15.00 g	3
090-30-180/10	18.00 g	3
090-30-200/10	20.00 g	3

NEW XPS SPLIT SHOT PLIER



Code	Description
101-40-560/10	Xps Split Shot Plier

STYL PLIER



Code	Description
101-40-500/10	Styl Plier

SONDE EVA



Code	Description	Weight	Pcs
093-10-020/10	Eva Plummet	20.0 g	2
093-10-030/10	Eva Plummet	30.0 g	2

NEW STAR DROPS WITH SILICONE TUBE



Code	Weight	Pcs
090-16-010/10	1.0 g	12
090-16-015/10	1.5 g	12
090-16-020/10	2.0 g	12
090-16-025/10	2.5 g	12
090-16-030/10	3.0 g	12
090-16-040/10	4.0 g	10
090-16-050/10	5.0 g	10
090-16-060/10	6.0 g	10
090-16-080/10	8.0 g	8
090-16-100/10	10.0 g	6
090-16-120/10	12.0 g	5
090-16-150/10	15.0 g	4

NEW STAR DROPS INLINE



Code	Weight	Pcs
090-18-010/10	1.0 g	20
090-18-015/10	1.5 g	20
090-18-020/10	2.0 g	20
090-18-025/10	2.5 g	20
090-18-030/10	3.0 g	20
090-18-040/10	4.0 g	15
090-18-050/10	5.0 g	15
090-18-060/10	6.0 g	15
090-18-080/10	8.0 g	15
090-18-100/10	10.0 g	15
090-18-120/10	12.0 g	10
090-18-150/10	15.0 g	10

FEEDERS & ACCESSORIES

Today, feeder fishing lives a magic moment, not only in Italy but also in the countries where it was popular many years before. This is due to the chance to get tremendous catches in any weather condition, to the short preparation time and to the simple tackle involved. But the sudden popularity has opened doors to those who just come in when it's easy to succeed; at Trabucco, we believe in feeder fishing since ever, and the old general catalogues provide the evidence through their pages. Even when the World Feeder Championship didn't exist at all, we already spent our best attention and care into feeder's development, with same passion which currently boosts our range to grow again.

AIRTEK SPECIALIST



Maurizio Biolcati

FLATBED METHOD FEEDER & FLEXY MOULD

Available in the Inline or Elasticated version. The Inline is equipped with a swivel for self strike rigging or for sliding rigging, used in combination with a Fast Change Bead. The Elasticated version allows you to use much thinner hook lengths. For both the versions the flat bed grants a strong grip on the bottom, while the peculiar ribbed design keeps the groundbait right in position.



Put some pre-damped ground bait into the mould and position the hook with the bait in the centre.



Fill the mould with the rest of the ground bait, taking care to cover the hook with the bait.



Carefully position the Method Feeder in centre of the mould and press firmly.



Press the bottom part of the mould to come out the Method feeder with the perfectly shaped ground bait.



When the feeder will lay on the bottom the bait will be positioned over the ground bait, that will start its attractive action.



When the ground bait will dissolve it will cover the whole feeder, while the bait will be ready to be swallowed by the fish.

FLATBED METHOD & MOULD

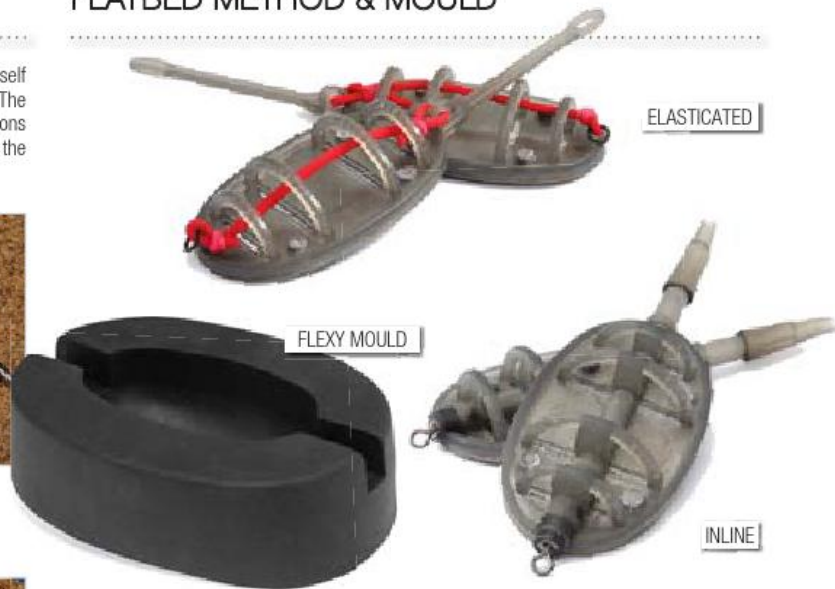

Code	Description	Size	Weight
140-66-100/10	Flatbed Method Feeder Inline * 2pcs	L	15+30 g
140-66-200/10	Flatbed Method Feeder Elasticated * 2pcs	L	15+30 g
140-66-300/10	Flexi Mould	-	-

MICRO PELLET FEEDER SET



Code	Description	Size	Weight
140-67-300/5	Micro Pellet Feeder * 5pcs Set	M	15+30 g



Mario Baptista

LONG DISTANCE FLATBED & MOULD



INLINE

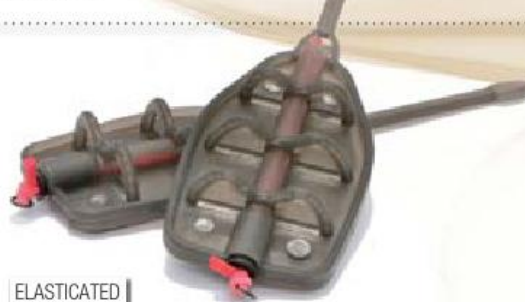

ELASTICATED



Code	Description	Size	Wt
140-68-115/10	LDF Method Inline	S	15 g
140-68-130/10	LDF Method Inline	L	35 g
140-68-145/10	LDF Method Inline	L	45 g

Code	Description	Size	Wt
140-68-215/10	LDF Method Elasticated	S	15 g
140-68-230/10	LDF Method Elasticated	L	35 g
140-68-245/10	LDF Method Elasticated	L	45 g

Code	Description	Size
140-68-000/10	LD Method Mould	S
140-68-010/10	LD Method Mould	L

EASY METHOD FEEDER SET



Code	Description	Size	Weight
140-67-400/5	Easy Method Feeder * 5pcs Set	L	20+30 g



FAST CHANGE BEAD

Born to complement any Method Feeder, the Fast Change Beads protect the hooklink knot from any damage coming from the feeder's weight and, at the same time, enable to quickly interchange several hooklinks without cutting it.



Code	Description	Pcs
101-57-000/10	Fast Change Beads	5

AIRTEK SPECIALIST MICRO PELLET FEEDER



How it appears the Micro Pellet Feeder as soon as it lands on the bottom. The pellets start to come out and the bait is already uncovered.



After a short time the pellets start to come out in a sort of small cascade, taking the bait with them. The bait is always perfectly presented.



The Micro Pellet Feeder can be used as well in combination with ground bait instead of pellets. The final result will be the same.

The micro pellet approach is one of the most recent introductions in Europe; it's effectiveness comes from the need to stimulate big fish without feeding it up. The small size of dedicated feeders are due to the extreme conditions of use. In fact, they are oriented to tough situations, which are common during the last hour of a match, in the highly pressured waters or in winter. In all such three circumstances, fish feed on small sized bait in limited amounts of groundbait, often refusing to bite in case the hooklink is not thin enough. Trabucco range include two solutions: a standard one and an elasticated one, purposely developed for extremely shy fish, when a fine line is absolutely worth a try.

Code	Description	Size	Wt
140-67-010/10	Pellet Feeder Inline	M	24 g
140-67-020/10	Pellet Feeder Inline	L	35 g
140-67-110/10	Pellet Feeder Elasticated	M	24 g
140-67-120/10	Pellet Feeder Elasticated	L	35 g

PELLET FEEDER



The feeder is on the bottom and the ground bait starts to segregate, freeing the feeder content.



The ground bait has accomplished its restraint job and it is now melted: all the pellets are now free to come out.

The Pellet Feeder has been designed to be used with pellets. The pellets must be dampened and then gently pressed into the feeder and then blocked with a groundbait stopper. The action of the water will dissolve the groundbait stopper and will consequentially allow the pellets to come out towards the hook length.

OPEN END

The Airtek Specialist Open End is equipped with a wide shaped lead to increase the stability. The link between the feeder and the main line is semi-rigid, to obtain an anti tangle effect. The camo colour hides the feeder to the spooky fish, melting its shape with the natural colour of the surrounding environment.



Code	Description	Wt
140-65-210/5	Pellet Feeder	28g
140-65-220/5	Pellet Feeder	56g
140-65-230/5	Pellet Feeder	84g
140-65-240/5	Pellet Feeder	112g

Code	Description	Wt
140-65-010/5	Open End	28 g
140-65-020/5	Open End	56 g
140-65-030/5	Open End	84 g
140-65-040/5	Open End	112 g

POWERGUM

Powergum is a clear and elastic line, well known among feeder anglers for rig and stopper knot's making.



Code	Description	Ø
102-81-010/10	Power Gum	1.0 mm
102-81-020/10	Power Gum	1.3 mm
102-81-030/10	Power Gum	1.5 mm

NEW AIRTEK TWISTED FEEDER LINK



Simple and helpful for the newcomer, quick and efficient for the expert feeder angler. These new rig links offer everybody something good, with their controlled elasticity and anti-tangle properties of the twisted monofilament structure and the convenience of the two swivels at both ends, one of which is also fitting a snap. They can be employed in two ways, as they can become paternoster links for fixed or sliding feeder set-ups, or inserted between main line and hooklength to stiffen the area and act as shock buffer just below the feeder. In this case, a rubber bead should be added to protect knot from being hammered by the feeder itself. The green colour adds camouflage effect to avoid scaring shy fish.

Code	Description	Size	Pcs	Length
102-81-500/10	Airtek Twisted Feeder Link	S	2	20 cm
102-81-510/10	Airtek Twisted Feeder Link	L	2	30 cm

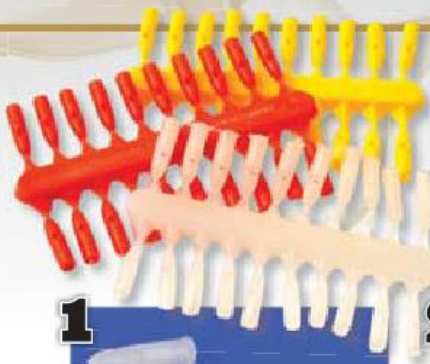

QUICKSTOP

The innovative Trabucco Competition Quickstop are a major breakthrough in bait stop design. Permanently attached to the hair, Quickstop reduce baiting time down and make attaching small baits like meat, corn and mini boilies super fast. The best, most convenient bait stops ever produced.

Code	Description	Pcs
101-58-000/10	Quickstops	60



1 Insert a baiting needle into the Quickstop on your hair rig.



2 Gently push the baiting needle (with the Quickstop on it) through the bait.



3 The finished presentation is absolutely spot on.

PASTE SPRING SET



Code	Description	Pcs
101-58-200/10	Paste Spring Set	3 sets

PASTE GRIPPER



Paste fishing made it easy! They're designed to alleviate missing bites and the paste coming off during the cast, two most common problems associated with paste fishing. It is basically a small rubber ball that has a stem attached to it, through which the hook point is passed. The paste is then moulded around the ball, stem and shank of the hook, leaving the point and part of the bend exposed. The Paste Gripper can be positioned at any point on the hook, to suit the anglers requirements eg. with the hook point coming out of the side or top of the ball of paste. It can be easily removed from barbless or semi-barbless hooks, and re-used many times. Suitable for almost all hook sizes.

Code	Description	Pcs
101-58-100/10	Paste Grippers	10

NEW HEAVY DUTY ANTI TANGLE TUBE

Strongly hated by feeder experts and conversely loved by millions of newcomers or pleasure anglers, who appreciate their efficiency and their anti-tangle properties in fresh and also salt water fishing. The main line gets through the bent tube, which protects it from any abrasion, and is knotted to the swivel of the hooklink. Just above the swivel, a rubber bead is highly recommended to protect the knot. The safety snap is ready to accept bomb or feeder: less than one minute and it's ready to fish! Three sizes are available: generally, the closer casting distance (or boat fishing) require the shortest tube, while longer range sees the longer tube getting into play.



Code	Description	Length	Pcs
101-55-650/10	Heavy Duty Anti Tangle Tube	55 mm	2
101-55-660/10	Heavy Duty Anti Tangle Tube	85 mm	2
101-55-670/10	Heavy Duty Anti Tangle Tube	120 mm	2

SLIDER FEEDER LINK

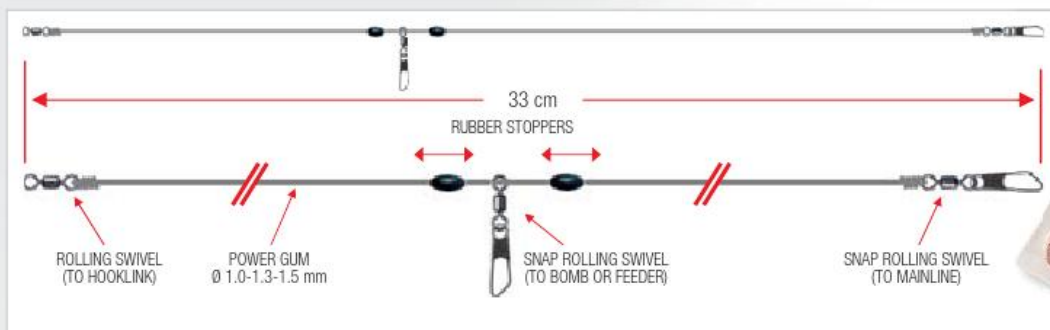

A great solution to solve a long list of problems of the feeder rigs. A segment of Power Gum, featuring a swivel snap on top and a swivel on the opposite end, lays flat on the bottom and provides elasticity, resistance and anti-tangle safety. Other advantage raises from the central snap, as it ensures speed and simplicity on bomb or feeder changes. Thanks to the oval rubber stoppers, the snap position can vary along the Powergum link according to fishing conditions. It can be used also connecting the feeder to the end of the link and hooklength to the central snap.



Code	Description	Pcs	Ø
102-81-100/10	Slider Feeder Link	2	1.0 mm
102-81-110/10	Slider Feeder Link	2	1.3 mm
102-81-120/10	Slider Feeder Link	2	1.5 mm

AIRTEK FEEDER

A really wide choice of feeder that are useful for a number of fishing situations but that has been designed to always perform at best and helping you to get really big fish. Every shape, every size

and weight, even every colour, has been carefully selected after a long time field testing made by our consultants in Italy and in the whole Europe.

CAGE FEEDERS

Cage are the veterans of feeder's field, because they born in the seventies, when some UK pioneer started using hair curlers. Their main merit is the quick and complete idruration of the content, also in case the groundbait has been wrongly dampened. A cage feeder rarely gets back with groundbait still inside, after a reasonable time, ensuring an optimal dispersion in the targeted swim and avoiding to create a groundbait trail when a fish is being played. Cage feeders also leave room to user's creativity, as between two groundbait plugs he can store a ball of sticky maggots, worms, casters, hemp, sweetcorn, pellets and everything can attract and stimulate fish in the middle of a groundbait cloud. Today, Trabucco introduces three new models, two of which are specialized in long range fishing, essential for the largest canals like Ostellato, but equally useful everywhere fish feed at the horizon.

NEW AIRTEK LONG RANGE CAGE FEEDER



Model for still water's long range, loaded at one end to ease the cast and sit upright on the bottom, thus providing a great sensitivity. The connection is based on snap swivel included in a strong monofilament loop. The "spodding" version is fairly large to introduce big quantity of groundbait at the start of the match or fishing session.

Code	Description	Size	Pcs	Wt
140-60-810/5	Airtek Long Range Cage Feeder	M	2	20 g
140-60-820/5	Airtek Long Range Cage Feeder	M	2	30 g
140-60-830/5	Airtek Long Range Cage Feeder	M	2	40 g
140-60-840/5	Airtek Long Range Cage Feeder	L	2	30 g
140-60-850/5	Airtek Long Range Cage Feeder	L	2	40 g
140-60-860/5	Airtek Spodding Cage Feeder	L	2	50 g
140-60-870/5	Airtek Spodding Cage Feeder	XL	2	30 g

AIRTEK LONG RANGE ROCKET FEEDER



Designed for extreme range fishing thanks to the compact, aerodynamic weight which is forwarded from body's centre to let it fly as a rocket. The weight is linked to frame through two arms only, so that the filling operation is quite easy by fingers. The connection is created by a strong monofilament loop.

Code	Description	Size	Pcs	Wt
140-60-910/5	Airtek Long Range Rocket Feeder	S	2	20 g
140-60-920/5	Airtek Long Range Rocket Feeder	S	2	30 g
140-60-930/5	Airtek Long Range Rocket Feeder	S	2	40 g
140-60-940/5	Airtek Long Range Rocket Feeder	M	2	30 g
140-60-950/5	Airtek Long Range Rocket Feeder	M	2	40 g
140-60-960/5	Airtek Long Range Rocket Feeder	M	2	50 g



Mario Baptista

AIRTEK CAGE

This model features a limited volume/weight ratio, therefore it keeps the bottom also when the river is pushing hardly. The plastic frame can bear any shock, while the rubber o-ring absorbs the stress otherwise destined to the line. The internal teeth grip the groundbait during the most powerful casts.



Code	Description	Pcs	Weight
140-60-310/5	Airtek Cage Feeder	2	20 g
140-60-320/5	Airtek Cage Feeder	2	30 g
140-60-330/5	Airtek Cage Feeder	2	40 g
140-60-340/5	Airtek Cage Feeder	2	50 g

NEW AIRTEK WIRE CAGE FEEDER

Classic cage feeders with metal wire frame, they feature a wide foot weight for the best stability once on river's bottom. The snap swivel is trapped within a rubber o-ring which is destined to absorb the casting load and work as anti-tangle. Two combinations of volume and weight are available to offer maximum versatility.



Code	Description	Size	Pcs	Weight
140-59-010/5	Airtek Wire Cage Feeder	S	2	20 g
140-59-020/5	Airtek Wire Cage Feeder	S	2	30 g
140-59-030/5	Airtek Wire Cage Feeder	M	2	20 g
140-59-040/5	Airtek Wire Cage Feeder	M	2	30 g
140-59-050/5	Airtek Wire Cage Feeder	M	2	40 g



Balázs Németh

AIRTEK FLAT

Code	Description	Size	Pcs	Wt
140-60-110/5	Airtek Flat	M	2	35 g
140-60-120/5	Airtek Flat	M	2	50 g
140-60-130/5	Airtek Flat	L	2	60 g
140-60-140/5	Airtek Flat	L	2	80 g
140-60-150/5	Airtek Flat	XL	2	100 g



AIRTEK ROUND

Code	Description	Size	Pcs	Wt
140-60-210/5	Airtek Round	S	2	20 g
140-60-220/5	Airtek Round	M	2	30 g
140-60-230/5	Airtek Round	L	2	40 g



AIRTEK RIVER SPECIALIST

Code	Description	Pcs	Wt
140-61-080/5	Airtek River Specialist	2	80 g
140-61-100/5	Airtek River Specialist	2	100 g
140-61-125/5	Airtek River Specialist	2	125 g
140-61-150/5	Airtek River Specialist	2	150 g



FEEDERS & ACCESSORIES

OPEN END OVAL



Code	Description	Size	Weight
141-35-310/10	Open End Oval	S	14 g
141-35-320/10	Open End Oval	S	28 g
141-35-330/10	Open End Oval	M	21 g
141-35-340/10	Open End Oval	M	32 g
141-35-350/10	Open End Oval	L	28 g
141-35-360/10	Open End Oval	L	42 g

AIRTEK OPEN END



Code	Description	Pcs	Wt
140-60-410/5	Airtek Open End Feeder	2	30 g
140-60-420/5	Airtek Open End Feeder	2	40 g
140-60-430/5	Airtek Open End Feeder	2	50 g
140-60-440/5	Airtek Open End Feeder	2	70 g

AIRTEK INLINE OPEN END



NEW

Code	Description	Pcs	Wt
140-60-710/5	Airtek Inline Open End	2	30 g
140-60-720/5	Airtek Inline Open End	2	40 g
140-60-730/5	Airtek Inline Open End	2	50 g

BLOCKEND OVAL



Code	Description	Size	Wt
141-30-400/10	Blockend Oval Swimf.	L	60 g
141-30-500/10	Blockend Oval Swimf.	XL	100 g

LUGGAGE

GNT MATCH TEAM

The range of bags and rod holdalls called "Match Team", is the most technically advanced that exists in today's market - designed to carry all the necessary equipment on long fishing trips.

In particular, this range is dedicated to all those who devote themselves entirely to fishing contests and to those for who fishing is a hobby. All these products are water-resistant, anti-tear, have double slider zippers and are extremely durable. All bags and some rod holdalls have a rigid reinforced base, foam handles and adjustable shoulder strap for easier carrying. All seams are made with triple thread of wire. Brand new design and colour scheme.



THERMIC BAG

Code	Sizes
048-37-120	37x19x29 cm



MATCH EVA CARRYALL

Code	Sizes
048-37-080	41x38x31 cm



12 TUBES HOLDALL

Code	Sizes
048-37-010	190x35x26 cm



6 TUBES HOLDALL

Code	Sizes
048-37-000	190x23x26 cm



TOP KIT CASE

Code	Sizes
048-37-050	180x27x17 cm



MATCH ROD PRO CASE

Code	Sizes
048-37-020	160x24x17 cm





XL CARRYALL

Code	Sizes
048-37-070	60x40x45 cm



WATERPROOF KEEPNET BAG

Code	Sizes
048-37-110	60x15x60 cm



PRO-ORGANIZER

Code	Sizes
048-37-090	38x41x40 cm



MATCH ROD PRO
3+1

Code	Sizes
048-37-030	170x28x25 cm

MATCH ROD PRO
4+1

Code	Sizes
048-37-040	170x28x40 cm

WTP LINER KEEPNET BAG



Code	Sizes
048-37-170	60x20x45 cm

KEEPNET BAG



Code	Sizes
048-37-100	60x15x45 cm

GROUND BAIT BOWL W/HOOP



Code	Sizes
048-37-140	36x25 cm

GROUND. BOWL W/HOOP SMALL



Code	Sizes
048-37-150	36x15 cm

MAT



Code	Sizes
048-37-130	150x150 cm

LUGGAGE & SURF ACCESSORIES

NEW RUCKSACK

XTR SURFCASTING PRO TEAM

Surf casting match circuit is now quite important in width and depth. In other words, there aren't numbers only, but also quality, and the natural consequence is that Trabucco brand is highly considered among the top anglers.

The 2014 Individual Italian Championship, held on Sicilian beaches around Messina, has been sponsored by Trabucco rightly because the feeling with surf casting is particularly strong. And it's natural that the company always keep investing in product's development, as proved by the launch of this technical luggage range. The new items are quite rich in features and show a neat cosmetic imprint, with black and chartreuse combination which gives the market a strong signal. Using a waterproof and washable material weighing 1200 denier, bags, rucksacks and rod holdalls are built to last. The addition of plastic boxes with many compartments enables to take full advantage of the inside room to neatly store all accessories. The special paddings, the stiff bottoms, the handles and shoulder belts, the zippers and seams are made with great care and precision.



NEW HARD ROD CASE
1 COMPARTMENT

NEW HARD ROD CASE
2 COMPARTMENTS

NEW HARD ROD &
REEL CASE
2 COMPARTMENTS ...

NEW HARD ROD &
REEL CASE
2+1 COMPARTMENTS

Code	Sizes
048-42-000	186x14x16cm

Code	Sizes
048-42-010	186x37x16 cm

Code	Sizes
048-42-020	186x20x16 cm

Code	Sizes
048-42-030	186x34x16 cm

NEW BACK PACK MATCH



Code	Sizes
048-42-050	54x34x22 cm



Code	Sizes
048-42-080	38x30x20 cm

NEW MATCH CARRYALL



Code	Sizes
048-42-060	38x40x22 cm

NEW COMPETITION CARRYALL



Code	Sizes
048-42-070	42x50x28 cm

NEW PRO ORGANIZER



Code	Sizes
048-42-040	46x40x30 cm

COMPETITION PRO LUGGAGE

Along with GNT range, which is located on top of Trabucco line-up, now we introduce a new assortment of luggage, featuring better prices even though the quality is certainly high.

Born to offer nice solutions to club anglers or pleasure anglers who like the best, is made from a 600 denier fabric, which is located above the average in term of thickness, waterproofing and durability. The balanced combination of lightness and stiffness is destined to draw the attention of every sort of fresh and salt water anglers; people skilled enough to recognize Trabucco quality in rods and reels, thus like to adequately protect their jewels. As always, graphic is particularly young, and technical solutions oriented to simplicity.



NEW COMPETITION
ROD & REEL
HOLDALL 2DLX

Code	Sizes
048-45-010	160x25x20 cm

NEW COMPETITION
ROD & REEL HOLDALL
2 HARD BOTTOM

Code	Sizes
048-45-020	170x25x20 cm

NEW COMPETITION
ROD & REEL
HOLDALL 2+1

Code	Sizes
048-45-030	170x45x28 cm

NEW COMPETITION
ROD & REEL
HOLDALL 2

Code	Sizes
048-45-040	170x30x28 cm

NEW COMPETITION
ROD HOLDALL

Code	Sizes
048-45-060	155x20x10 cm

NEW ACCESSORIES BAG



Code	Sizes
048-45-070	27x7x18 cm

NEW COMPETITION CARRYALL



Code	Sizes
048-45-080	32x20x30 cm



NEW COMPETITION ROD & REEL HOLDALL 1

Code	Sizes
048-45-050	165x25x15 cm

NEW TACKLE BOX SYSTEM



Code	Description	Sizes
112-10-000	Tackle Box System 4 Drawers	32x54(h36)cm

ROD PROTECTIVE TUBES



Code	Description	Sizes
112-00-300	Rod Protective Tube 2 sections	160x220x15
112-00-400	Rod Protective Tube 3 sections	120x220x15

PVC ROD PROTECTIVE TUBES



Prism Tube / Pole Prism Tube / Top Kit Oval Tube

Code	Description	Sizes*
108-20-125	Prism Tube / Pole	1880x60
108-20-110	Prism Tube / Top Kit	1800x50
108-20-140	Oval Tube / Top Kit	1750x50x80

* Sizes = Length (mm) x Diameter (mm)

SURF BOX

This seat box is made to face any situation of surf casting or sea boat fishing. Thanks to the 70 liters capacity (54x37x40cm) it can carry big quantity of bulky product or hold a good number of tackle boxes for bits and pieces. The special plastic material used is extremely strong, easy to wash and keep all the stored items perfectly dry. It's sold with removable pillow and is possible to fit a bait bowl in three different position.

Code	Description
117-00-010	Surf Box - Side Tray
117-00-000	Surf Box



COMPETITION SURF BOX

This seat box is perfect when long walk is needed to reach the swim, like in big lakes or for surf casting. Ultra-light aluminium frame, one big drawer and a 48 litres capacity inner section. The seat is well padded, two side pockets, one front pocket. All the feet are adjustable to make it stable in any condition. Easy to store thanks to the removable wheels.

Code
117-00-050



GENIUS WTP KEEPNET BAG

Code
048-39-010



GENIUS XPS
ROD HOLDALL 1/165

Code	Sizes
048-38-010	165x12x28 cm

GENIUS XPS
ROD HOLDALL 2/165

Code	Sizes
048-38-020	165x24x28 cm

GENIUS XPS
POLE ROD HOLDALL

Code	Sizes
048-38-040	187x18 cm

GENIUS XPS CARRYALL



Code	Sizes
048-38-050	61x23x42 cm

GENIUS XPS MATCH SET

Practical set including a rod holdall, carryall, mixing bowl and reel case. Excellent value for money.

Code	Description	Sizes
048-38-000	GENIUS XPS Match Set	
	Genius Xps Rod Holdall	18x187 cm
	Genius Carryall	61x32x42 cm
	Reel Case Genius	19x7x18 cm
	Genius Groundbait Bowl	40x17 cm



ADVANCED KEEPNET BAGS



Code	Description	Sizes
048-36-070	Net Bag Advanced Rectangular	56x56x14 cm
048-36-080	Net Bag Advanced Round	65x58x16 cm

CAP LIGHT W/BATTERY



Code
101-20-900

MAGNETIC LAMP 5 LED



Code
101-20-300

HEAD LAMP SWIVEL



Code
101-20-800

POCKET LAMP SWIVEL



Code
101-10-000

POCKET SCISSOR



Code
VV 0010 18 02

CHEMICAL LIGHT SUPPORT

Chemical light support to be applied to the rod's tip.



Code	Pcs
100-96-200	2

XPS TACKLE BOX



Code	Description
110-40-030	Aggressor Termic Box

Code	Description	Sizes
110-40-040	Valiant Hook Box	40x30x10 cm



**X-RIDE
SURF POD**



Code
088-65-900

**OVERCAST
ROD POD**



Code
088-65-700

**TOP RANGE
TRIPOD**

NEW



Code
088-65-350

OVERCAST SAND ROD POD

LUMINOUS



Code
088-65-650

BAIT INDICATOR PRO SURF

This is the latest innovation in surfcasting bite detection. The device must be applied on the reel line between the first and second guide from the butt, adjusting the weight according to the sea conditions: the heavier the weight, the less sensitive the indicator.

The surf indicator can be used either by day, fitting the specially provided multicolor antenna, or by night, fitting a 4.5mm chemical light.



Code
105-10-100/5



SURFCASTING BAITING NEEDLE



Special selection of high quality baiting needles, essential for surf casting. If the bait is badly positioned on the hook, it happens very frequently that the fish approaching it refuses to bite. That's why we offer you a series of selected premium needles, useful to always position your bait in the best and more natural possible way. The 0.6 mm diameter stainless steel needle (both ends blunt) is perfect with all the thinner worms, such as Mediterranean Arenicola and sandworm. The 0.9 mm diameter (both ends blunt) is available in two different length (20 and 30 cm) and it is perfect for baiting bigger worms such as lugworm, bibi, etc. The 1.4 mm needle is made of brass and features one pointy end. It is the good one for baiting dead fish slices.

Code	Description	Pcs	Ø	Size
105-10-300/10	Brass Needle	5	1.4	200 mm
105-10-310/10	Stainless Steel Needle	5	0.9	200 mm
105-10-320/10	Stainless Steel Needle	5	0.9	300 mm
105-10-330/10	Stainless Steel Needle	5	0.6	200 mm

SURF POP-UP STICK



Code	Description	Size
105-10-200/10	Surf Pop-Up Sticks	4 mm
105-10-210/10	Surf Pop-Up Sticks	6 mm
105-10-220/10	Surf Pop-Up Sticks	8 mm

ELASTIC LINE

Baits elastic line, transparent and very thin, it is excellent to tie the softer and most delicate baits on the hook. Supplied in 200m spools, or in the practical dispenser.



Dispenser Elastic Line



Code	Description	Length
105-00-000/10	Baits Elastic Line	200 m
105-00-050/10	Dispenser Elastic Line	100 m

EVA SPOOLS & BOX



Code	Description
105-11-000/5	S. Eva Spool Box 36
105-11-010/5	S. Eva Spool Box 72
105-11-050/10	S. Eva Spool 20Pcs

NEW PRO SURF BEADS

Code	Description	Pcs	Ø Int.	Ø Out.
104-51-900/10	White	100	0.6 mm	1.0 mm
104-51-910/10	Red	100	0.6 mm	1.0 mm
104-51-920/10	White	100	0.9 mm	2.0 mm
104-51-930/10	Red	100	0.9 mm	2.0 mm



NEW PROSURF KNOT CONES

LUMINOUS

Code	Size	Pcs
105-01-010/10	Small	20
105-01-020/10	Medium	20



SURF TEAM FINGER PROTECTOR



Our Finger Protector is a small but really important accessory who can't miss in the tackle box of any beach caster. Even when casting at extreme distance with heavy lead, your finger will be safe from injuries. The sensitivity will not be affected, as we have used a very soft fabric, and the soft neoprene cuff can fit to any size of wrist.

Code
105-10-000/20

SEA RIG TACKLE

Accessories line for salt water rig preparation, both for boat or surf/beach fishing. Each and every item has been designed to increase your fishing experience and to get maximum results from your rigs. All the accessories have been made from anti corrosion materials and so they can withstand the salt water.

HAWAIIAN SNAP W/BAIT CLIP



Code	Size	Pcs
104-50-000/10	03	6

HAWAIIAN SNAP W/EASY LINK



Code	Size	Pcs
104-50-010/10	03	6

LEAD QUICK LINK



Code	Size	Pcs
104-50-100/10	L	10

TRACES QUICK LINK



Code	Size	Pcs
104-50-400/10	S	10

LEAD LINK W/BAIT CLIP



Code	Size	Pcs
104-50-110/10	L	10

TRACES QUICK ROLLING SWIVEL



Code	Size	Pcs
104-50-500/10	SH	10

HIGH SPEED DOUBLE ROLLING



Code	Size	Pcs
104-51-410/10	04	10
104-51-420/10	06	10
104-51-430/10	08	10

SPARE BODY X ROLLARM



Code	Size	Pcs
104-50-640/10	07	6
104-50-650/10	05	6

WIRE BAIT CLIP



Code	Size	Pcs
104-50-200/10	01	10

WIRE BAIT CLIP REVERSED



Code	Size	Pcs
104-50-210/10	01	10

3 WAY CROSS SWIVELS



Code	Size	Pcs
104-51-000/10	-	10

CROSSLINE CRIMPABLE SWIVEL



Code	Size	Pcs
104-50-290/10	12	8
104-50-300/10	10	8
104-50-310/10	7	7
104-50-320/10	5	6

TRANSPARENT SHRINK TUBE



Code	Size	Pcs
104-51-210/10	1.0 mm	10
104-51-215/10	1.5 mm	10
104-51-220/10	2.0 mm	10
104-51-225/10	2.5 mm	10
104-51-230/10	3.0 mm	10

SHRINK TUBE



Code	Size	Pcs
104-50-700/10	3.0 mm	10

PVC STIFF TUBE



Code	Size	Pcs
104-50-720/10	2.0 mm	10

SILICON BLACK TUBE



Code	Size	Pcs
104-50-710/10	1.5 mm	10

ROLLARM



Code	Size	Pcs
104-50-600/10	10 cm	3
104-50-610/10	17 cm	3

SPARE ARM X ROLLARM



Code	Size	Pcs
104-50-620/10	10 cm	6
104-50-630/10	17 cm	6

ROUND BEADS RED



Code	Size	Pcs
104-45-600/10	3 mm	20
104-45-610/10	4 mm	20
104-45-620/10	5 mm	20

FLUO OVAL BEADS



Code	Size	Pcs
104-50-800/10	2x3 mm	100
104-50-810/10	3x4 mm	100
104-50-820/10	4x5 mm	100

FLUO ROUND BEADS RED



Code	Size	Pcs
104-45-400/10	4 mm	20
104-45-410/10	6 mm	20

FLUO OVAL BEADS GREEN



Code	Size	Pcs
104-45-100	4.5x6.5	20
104-45-110	7x10	20

FLUO ROUND BEADS YELLOW

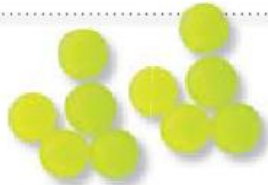

Code	Size	Pcs
104-45-300/10	4 mm	20
104-45-310/10	6 mm	20

CROSSLINE TRASPARENT BEADS



Code	Size	Pcs
104-45-500/10	5 mm	10
104-45-510/10	8 mm	10
104-45-520/10	10 mm	10

FLUO ROUND BEADS GREEN

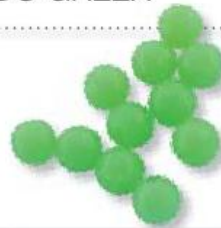

Code	Size	Pcs
104-45-000/10	4 mm	20
104-45-010/10	6 mm	20

ROUND BEADS PEARL



Code	Size	Pcs
104-45-200/10	4 mm	20
104-45-210/10	6 mm	20

LUMINOUS FLOAT STOP ROUND

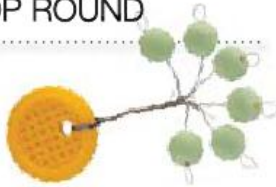

Code	Size	Pcs
104-51-810/10	#1 - Ø6.5 mm	6
104-51-820/10	#2 - Ø7.5 mm	6
104-51-830/10	#3 - Ø8.7 mm	6
104-51-840/10	#4 - Ø10 mm	6

LUMINOUS FLOAT STOP OVAL

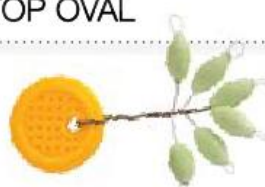

Code	Size	Pcs
104-51-710/10	#1 - 4.7x10 mm	6
104-51-720/10	#2 - 5.6x11 mm	6
104-51-730/10	#3 - 6.3x13 mm	6
104-51-740/10	#4 - 7.3x15 mm	6

ROLLING W/PEARL BEADS & STOPPERS



Code	Size	Pcs
104-51-510/10	S	4
104-51-520/10	M	4
104-51-530/10	L	4

LINE STOPPERS M



Code	Size	Pcs
104-50-900/10	M	14

FLUO FLOAT STOPPER

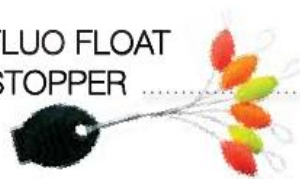

Code	Size	Pcs
104-50-910/10	4./x10	6

ROLLING SW.LEAD QUICK LINK



Code	Size	Pcs
104-51-300/10	02	12
104-51-310/10	04	12
104-51-320/10	06	12
104-51-330/10	08	12
104-51-340/10	10	12

SHRINKING RUB. SNAP



Code	Size	Pcs
104-50-050/10	S	5
104-50-060/10	M	5
104-50-070/10	L	5

DIAM. ROLLING W/GREEN BEADS & STOPPERS



Code	Size	Pcs
104-51-610/10	S	4
104-51-620/10	M	4
104-51-630/10	L	4

SWIVELS



ROLLING ROUND X-PATTERN



04 06 08 10 12 14 16 20 22 24

Code	Size	Pcs	Kg	Lbs
100-64-040/12	04	12	47	104
100-64-060/12	06	12	43	95
100-64-080/12	08	12	40	88
100-64-100/12	10	12	35	77
100-64-120/12	12	12	32	71
100-64-140/12	14	12	27	60
100-64-160/12	16	12	22	49
100-64-200/12	20	12	14	31
100-64-220/12	22	12	9	20
100-64-240/12	24	12	4	9

ROLLING GERMAN SNAP



08 12 14 16 18 20 22



Code	Size	Pcs	Kg	Lbs
100-67-100/10	08	5	40	88
100-67-120/10	12	5	30	66
100-67-140/10	14	5	25	55
100-67-160/10	16	5	15	33
100-67-180/10	18	5	10	22
100-67-200/10	20	5	10	22
100-67-220/10	22	5	7	15

MINI ROLLING ROUND

Code	Size	Pcs	Kg	Lbs
100-65-200/12	20	12	14	31
100-65-220/12	22	12	9	20
100-65-240/12	24	12	4	9



20 22 24

ROLLING HOOKED SNAP



08 10 12 14 16 18 20 22



Code	Size	Pcs	Kg	Lbs
100-66-080/12	08	12	40	88
100-66-100/12	10	12	40	88
100-66-120/12	12	12	35	77
100-66-140/12	14	12	28	62
100-66-160/12	16	12	20	44
100-66-180/12	18	12	12	26
100-66-200/12	20	12	12	26
100-66-220/12	22	12	9	20

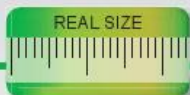

ROLLING INTERLOCK SNAP

Code	Size	Pcs	Kg	Lbs
100-80-100/12	10	12	14	30
100-80-120/12	12	12	14	30
100-80-140/12	14	12	12	27
100-80-160/12	16	12	12	27
100-80-180/12	18	12	7	15
100-80-200/12	20	12	7	15



BARREL



Code	Size	Pcs	Kg	Lbs
100-61-040/12	04	12	30	66
100-61-060/12	06	12	27	60
100-61-080/12	08	12	20	44
100-61-100/12	10	12	16	35
100-61-120/12	12	12	14	31
100-61-140/12	14	12	10	22
100-61-160/12	16	12	8	18
100-61-180/12	18	12	7	15

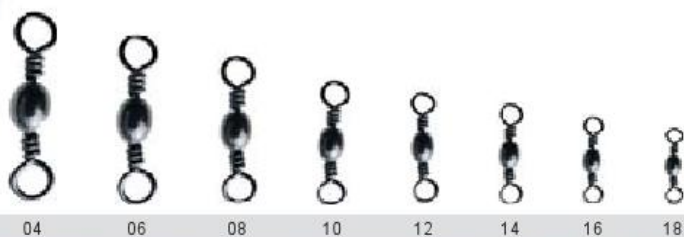

BARREL INTERLOCK SNAP

Code	Size	Pcs	Kg	Lbs
100-62-040/12	04	12	25	55
100-62-060/12	06	12	18	40
100-62-080/12	08	12	14	31
100-62-100/12	10	12	14	31
100-62-120/12	12	12	12	26
100-62-140/12	14	12	10	22
100-62-160/12	16	12	8	18
100-62-180/12	18	12	7	15
100-62-200/12	20	12	6	13

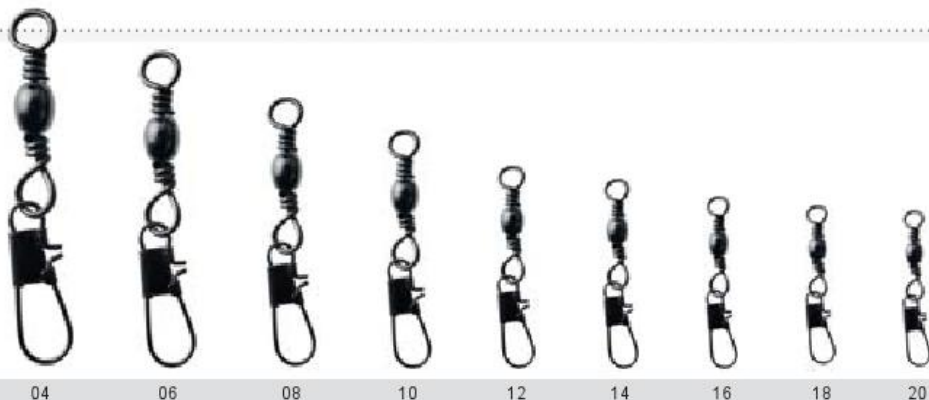

BARREL SAFETY SNAP



Code	Size	Pcs	Kg	Lbs
100-63-040/12	04	12	15	33
100-63-060/12	06	12	13	29
100-63-080/12	08	12	9	20
100-63-100/12	10	12	9	20
100-63-120/12	12	12	7	15
100-63-140/12	14	12	7	15
100-63-160/12	16	12	5	11
100-63-180/12	18	12	5	11

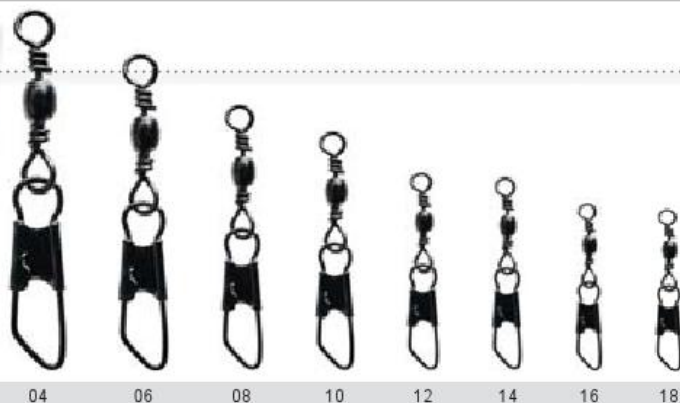

ROLLING HS2



Code	Size	Pcs	Kg	Lbs
100-68-160/10	16	6	22	49
100-68-180/10	18	6	19	42
100-68-200/10	20	6	14	31
100-68-220/10	22	6	9	20
100-68-240/10	24	6	4	9



ROLLING HS2 HOOKED SNAP



Code	Size	Pcs	Kg	Lbs
100-69-160/10	16	6	20	44
100-69-180/10	18	6	12	26
100-69-200/10	20	6	12	26
100-69-220/10	22	6	9	20

16 18 20 22

ROLLING HS3



Code	Size	Pcs	Kg	Lbs
100-70-160/10	16	6	22	49
100-70-180/10	18	6	19	42
100-70-200/10	20	6	14	31
100-70-220/10	22	6	9	20
100-70-240/10	24	6	4	9

16 18 20 22 24

ROLLING HS3 SAFETY SNAP



Code	Size	Pcs	Kg	Lbs
100-71-180/10	18	6	5	11
100-71-200/10	20	6	5	11
100-71-220/10	22	6	3	7

18 20 22

ROLLING 3 JOINTED

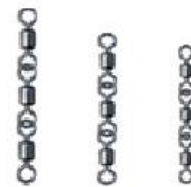

Code	Size	Pcs	Kg	Lbs
100-82-200/10	20	10	14	30
100-82-220/10	22	10	9	20
100-82-240/10	24	10	4	9

20 22 24

ROLLING 3 JOINTED SAFETY SNAP



Code	Size	Pcs	Kg	Lbs
100-83-200/10	20	10	5	11
100-83-220/10	22	10	5	11
100-83-240/10	24	10	3	7

20 22 24

HS ROLLING SPECIAL



Code	Size	Pcs	Kg
100-53-001/10	0	10	-
100-53-010/10	1	10	-
100-53-020/10	2	10	-

0 1 2

GERMAN B SNAP

Code	Size	Pcs	Kg	Lbs
100-79-020/10	2/0	10	25	55
100-79-010/10	1/0	10	15	33
100-79-002/10	0	10	10	22
100-79-001/10	00	10	7	15
100-79-000/10	000	10	6	13

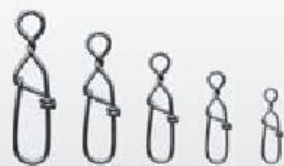

2/0 1/0 0 00 000

DIAMOND INSURANCE SNAP

Code	Size	Pcs	Kg	Lbs
100-78-040/10	4/0	10	55	120
100-78-030/10	3/0	10	40	90
100-78-020/10	2/0	10	30	65
100-78-010/10	1/0	10	15	33
100-78-000/10	0	10	10	22



4/0 3/0 2/0 1/0 0

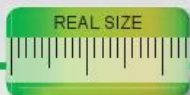

NEW WRAPPING SNAPS

Code	Size	Pcs	Kg	Lbs
100-89-010/10	S	10	12	27
100-89-020/10	M	10	18	40
100-89-030/10	L	10	25	55

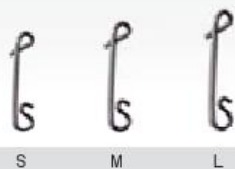

NEW OVAL ALUMINIUM CRIMPS

Code	Ø Inner	Length	Pcs	Ø Line Range
100-44-500/10	0.8/1.7 mm	6.5 mm	20	0.45-0.70 mm
100-44-510/10	1.0/2.0 mm	10.0 mm	20	0.60-0.90 mm
100-44-520/10	1.2/2.4 mm	10.0 mm	20	0.90-1.10 mm
100-44-530/10	1.4/2.8 mm	10.0 mm	20	1.00-1.30 mm
100-44-540/10	1.6/3.2 mm	10.0 mm	20	1.20-1.40 mm
100-44-550/10	1.8/3.6 mm	18.0 mm	20	1.40-1.70 mm



SLEEVE TUBES

Code	Size	Pcs
100-44-200/10	2.00 mm	10
100-44-180/10	1.80 mm	10
100-44-160/10	1.60 mm	10
100-44-140/10	1.40 mm	10
100-44-120/10	1.20 mm	10
100-44-100/10	1.00 mm	10
100-44-075/10	0.75 mm	10
100-44-050/10	0.50 mm	10

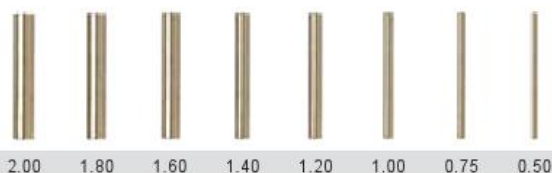

COMPETITION FLOAT STOPPERS

Code	Size	Ø Line Range
101-65-530/12	#S	0.16-0.37 mm
101-65-520/12	#SS - (2S)	0.14-0.28 mm
101-65-510/12	#SSS - (3S)	0.12-0.24 mm
101-65-500/12	#SSSS - (4S)	0.10-0.20 mm



Code	Size	Ø Line Range
101-65-430/12	#S	0.16-0.37 mm
101-65-420/12	#SS - (2S)	0.14-0.28 mm
101-65-410/12	#SSS - (3S)	0.12-0.24 mm
101-65-400/12	#SSSS - (4S)	0.10-0.20 mm

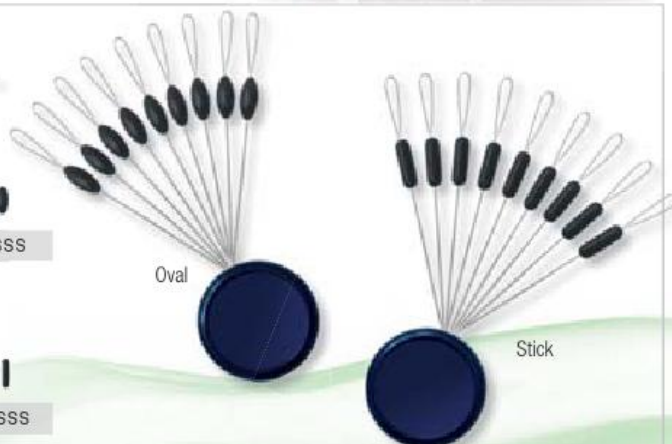
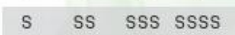

Code	Description	Size
105-65-000/10	Float Stopper Combined Black	-
105-65-010/10	Float Stopper Black	S
105-65-020/10	Float Stopper Black	M
105-65-030/10	Float Stopper Black	L
105-65-040/10	Float Stopper Black	XL
105-65-100/10	Float Stopper Combined Natural	-
105-65-110/10	Float Stopper Natural	S
105-65-120/10	Float Stopper Natural	M
105-65-130/10	Float Stopper Natural	L
105-65-140/10	Float Stopper Natural	XL
105-65-210/10	Float Stopper Multicolour 201	S
105-65-220/10	Float Stopper Multicolour 202	M
105-65-230/10	Float Stopper Multicolour 203	L
105-65-310/10	Float Stopper Multicolour 401	S
105-65-320/10	Float Stopper Multicolour 402	M
105-65-330/10	Float Stopper Multicolour 403	L

BB SWIVEL COSTLOCK SNAP



Code	Size	Pcs	Kg	Lbs
100-76-080/10	08	5	110	245
100-76-070/10	07	6	90	200
100-76-060/10	06	7	70	155
100-76-050/10	05	8	55	120



08 07 06 05



NEW EGG SNAPS

Code	Size	Pcs	Kg	Lbs
100-88-040/10	4	20	55	120
100-88-030/10	3	20	40	88
100-88-020/10	2	20	30	66
100-88-010/10	1	20	15	33
100-88-005/10	0	20	10	22



4 3 2 1 0

NEW BB SWIVEL WITH SOLID RINGS

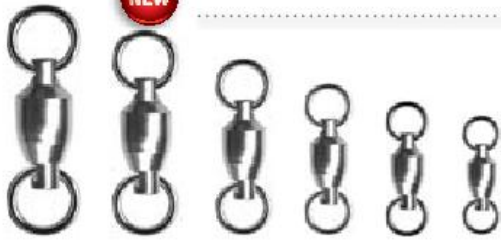

Code	Size	Pcs	Kg	Lbs
100-87-010/10	01	6	20	44
100-87-020/10	02	6	25	55
100-87-030/10	03	6	35	77
100-87-040/10	04	6	50	110
100-87-050/10	05	6	65	143
100-87-060/10	06	6	80	176

06 05 04 03 02 01

CROSSLINE CRANE



Code	Size	Pcs	Ø	Kg	Lbs
100-75-008/10	2/0	6	2.5 mm	75	165
100-75-009/10	1/0	8	2.3 mm	60	135
100-75-010/10	01	8	2.1 mm	47	105
100-75-020/10	02	10	1.9 mm	43	95
100-75-040/10	04	10	1.4 mm	35	77

2/0 1/0 01 02 04

X-STRONG CRANE



Code	Size	Pcs	Kg	Lbs
100-74-006/10	4/0	6	135	300
100-74-007/10	3/0	6	100	220
100-74-008/10	2/0	8	75	165
100-74-009/10	1/0	10	60	135
100-74-010/10	01	12	47	105
100-74-020/10	02	12	43	95
100-74-040/10	04	12	35	77

4/0 3/0 2/0 1/0 01 02 04



X-STRONG CRANE COASTLOCK SNAP

Code	Size	Pcs	Kg	Lbs
100-77-007/10	3/0	8	70	155
100-77-008/10	2/0	8	55	120
100-77-009/10	1/0	10	45	100
100-77-010/10	01	10	45	100
100-77-020/10	02	10	35	75
100-77-040/10	04	10	22	50



3/0 2/0 1/0 01 02 04

X-STRONG ROLLING INSURANCE SNAP

Code	Size	Pcs	Kg	Lbs
100-81-008/10	2/0	8	70	155
100-81-009/10	1/0	10	55	120
100-81-010/10	01	10	55	120
100-81-020/10	02	10	40	90
100-81-040/10	04	10	30	65
100-81-060/10	06	10	15	35



2/0 1/0 01 02 04 06

SS POWER SWIVEL

HEAVY DUTY STAINLESS STEEL

X-STRONG CRANE

Code	Size	Pcs	Kg	Lbs
100-85-008/10	2/0	8	360	800
100-85-009/10	1/0	8	275	600
100-85-010/10	01	8	225	500
100-85-030/10	03	10	140	310
100-85-050/10	05	10	100	220
100-85-070/10	07	10	82	180
100-85-100/10	10	10	68	150
100-85-120/10	12	10	45	100



2/0 1/0 01 03 05 07 10 12

X-STRONG CRANE COASTLOCK SNAP

Code	Size	Pcs	Kg	Lbs
100-86-008/10	2/0	6	250	550
100-86-010/10	01	8	135	300
100-86-030/10	03	10	115	250
100-86-050/10	05	10	90	200
100-86-070/10	07	10	68	150
100-86-100/10	10	10	60	130



2/0 01 03 05 07 10

Slurp!

Artificial baits

Trabucco's Soft Lures are made of superior quality material, soft but still durable. These powerful scented lures are packed in a preserving oil that will maintain their outstanding performance. Every and each Soft Lure has its own design which is specific and effective, tested and improved by our Pro Team for long time before launching it in the market. We are committed to achieve details perfection and absolute quality to get the best performance. Try them and you won't regret!



HONEY WORM

Honey Worms are available in two sizes, Regular and XL. These floating baits have a bent shape to increase the twisting action needed to appeal the trout and other predators. They can be used alone or in combination with other soft or live bait. The Honey Worms texture is really similar if not the very same of the live honey worms but they will always be available and they will not be spoiled after the first catch, being able to be re used several times before substitution.



Code	Description	Colour	Pcs
182-00-210/10	Honey Worm	Natural White	30
182-00-220/10	Honey Worm	Yellow Glitter	30
182-00-230/10	Honey Worm	Fluo Glitter	30
182-00-240/10	Honey Worm	Red Glitter	30
182-00-250/10	Honey Worm	Pink Glitter	30
182-00-260/10	Honey Worm	Silver Glitter	30
182-00-310/10	Honey Worm XL	Natural White	25
182-00-320/10	Honey Worm XL	Yellow Glitter	25
182-00-330/10	Honey Worm XL	Fluo Glitter	25
182-00-340/10	Honey Worm XL	Red Glitter	25
182-00-350/10	Honey Worm XL	Pink Glitter	25
182-00-360/10	Honey Worm XL	Silver Glitter	25

10 / Natural White

20 / Yellow Glitter

30 / Fluo Glitter

40 / Red Glitter

50 / Pink Glitter

60 / Silver Glitter



FAT TROUT WORM

Fat Worm is a small compact worm that perfectly imitates the live bait. It can be used in combination with other lures, fishing with bombarda, it can be used rigged on a Rapture Jig Head, to make it dance on the bottom triggering the killer instinct of all trout species, including the wild mountain brown ones, and finally it can be rigged wacky without any weight, to get the super natural action of a worm falling through the water. All Fat Worms are fish scented. When the trout will bite, it will never stop chewing this delicatessen, allowing you an accurate and winning strike.



10 / White Glitter

20 / Black Glitter

30 / Pinky



40 / Fluo Green

50 / Flame

60 / Pearl & Brown



Code	Description	Colour	Pcs
182-00-510/10	Fat Trout Worm	White Glitter	10
182-00-520/10	Fat Trout Worm	Black Glitter	10
182-00-530/10	Fat Trout Worm	Pinky	10
182-00-540/10	Fat Trout Worm	Fluo Green	10
182-00-550/10	Fat Trout Worm	Flame	10
182-00-560/10	Fat Trout Worm	Pearl & Brown	10



MAGGOTS

Maggots are very likely the most used bait in Europe, both in fresh and salt-water. Slurp! Maggots are floating and they are just perfect to improve any bait presentation, counterbalancing the hook weight. Same texture of live maggots. Very effective for carp fishing as well.

Code	Description	Colour	Pcs
182-00-010/10	Maggot	Natural White	50
182-00-020/10	Maggot	Blood Red	50
182-00-030/10	Maggot	Yellow	50
182-00-040/10	Maggot	Red Glitter	50

10 / Natural White

20 / Blood Red

30 / Yellow



40 / Red Glitter



SPAGHETTI

Spaghetti are a classic and very popular bait for lake trout fishing in commercial fisheries. We added scent and oils in the formula of the Spaghetti Slurp! Baits, making them irresistible and giving you the edge to catch fish in every situation, when every other lure or bait already failed. All colours are very bright and vivid, to stimulate even the most apathetic trout.



Marco De Biase

BLOOD WORM

Slurp! Blood Worm is the perfect imitation of the Ver de Vase, the typical and most natural bait that normally lives in lakes and canals. So they are the most convenient baits for a large variety of fish, such as carp, crucian carp, bream etc. Available in its peculiar blood red colour.



Code	Description	Colour	Pcs
182-00-110/10	Blood Worm	Blood Red	50



10 / White

20 / Orange Glitter

30 / Yellow

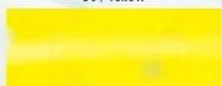
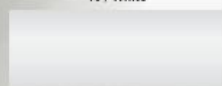

Code	Description	Colour	Pcs
182-00-410/10	Spaghetti	White	12
182-00-420/10	Spaghetti	Orange Glitter	12
182-00-430/10	Spaghetti	Yellow	12

The Yummy Baits are the trout's favourite of all times! Their texture is really super soft, so soft you've never seen a similar bait. Fish will bite with confidence such a sweetie! Yummy Baits are elastic too, so they are super resistant and can be used and used again. The lifelike texture has been super charged with fish scent for extra trigger action. You never had such a powerful bait on your hook!

YUMMY Bait

POWER SCENTED



Super soft

FALCETTO

In contrast to many other grubs, the Falchetto generates a high-efficient rotation movement thanks to its broad and short tail. Trout can thus easily detect these vibrations and smell the scent of the lure. Falchetto is anise scented in white colour and fish scented in all other colours. Eight pieces in a resealable plastic bag.

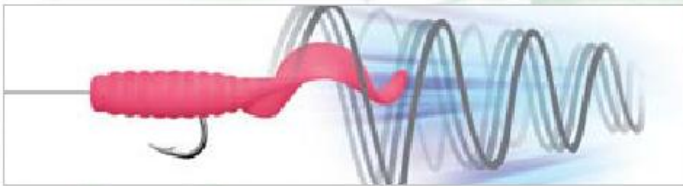

The broad and short tail generates a rotation and high frequency vibrations.

Code	Description	Colour	Pcs
182-12-010/10	Yummy Bait Falchetto	White	8
182-12-020/10	Yummy Bait Falchetto	Natural	8
182-12-030/10	Yummy Bait Falchetto	Cream	8
182-12-040/10	Yummy Bait Falchetto	Blood Red	8
182-12-050/10	Yummy Bait Falchetto	Bubble Gum	8
182-12-060/10	Yummy Bait Falchetto	Yellow	8
182-12-070/10	Yummy Bait Falchetto	Orange	8
182-12-080/10	Yummy Bait Falchetto	Green Chartreuse	8



BRUCONE



The Brucone is a perfectly shaped rotating lure which twists around its own axis during the retrieve and produces strong trout reactions. Less experienced anglers can use a baiting needle to correctly position this lure on the hook. The Brucone worms are delivered per 8 pieces in a resealable plastic bag. The white colour is anise scented, while all the other colours are fish scented.



Code	Description	Colour	Pcs
182-10-010/10	Yummy Bait Brucone	White	8
182-10-020/10	Yummy Bait Brucone	Natural	8
182-10-030/10	Yummy Bait Brucone	Cream	8
182-10-040/10	Yummy Bait Brucone	Blood Red	8
182-10-050/10	Yummy Bait Brucone	Bubble Gum	8
182-10-060/10	Yummy Bait Brucone	Yellow	8
182-10-070/10	Yummy Bait Brucone	Orange	8
182-10-080/10	Yummy Bait Brucone	Green Chartreuse	8



Perfect hooking of the Brucone. This rigging generates an active rotation with intensive vibrations.



TAIL TWISTER

The Tail Twister is a preformed trout lure, which is rotating around its own axis during the retrieve and generates extraordinary intensive vibrations thanks to its round flat belly, driving crazy the laziest trout. A great trout and perch lure that can't be missing in any lure box. The Tail Twister is delivered per 8 pieces in a resealable plastic bag. The white colour is anise scented, while all the other colours are fish scented. From today, a smaller size is also available to widen the chances of this fantastic lure.



Perfect rigging of the Tail Twister with active rotation – the hook is buried within the body close to its round flat belly.



In order to increase rotation and the vibration's frequency, just bring the hook point out of the first part of the tail. But not too low!



Code	Description	Colour	Pcs
182-13-010/10	Yummy Bait Tail Twister	White	8
182-13-020/10	Yummy Bait Tail Twister	Natural	8
182-13-030/10	Yummy Bait Tail Twister	Cream	8
182-13-040/10	Yummy Bait Tail Twister	Blood Red	8
182-13-050/10	Yummy Bait Tail Twister	Bubble Gum	8
182-13-060/10	Yummy Bait Tail Twister	Yellow	8
182-13-070/10	Yummy Bait Tail Twister	Orange	8
182-13-080/10	Yummy Bait Tail Twister	Green Chartreuse	8
182-14-010/10	Yummy Bait Tail Twister Mini	White	8
182-14-020/10	Yummy Bait Tail Twister Mini	Natural	8
182-14-030/10	Yummy Bait Tail Twister Mini	Cream	8
182-14-040/10	Yummy Bait Tail Twister Mini	Blood Red	8
182-14-050/10	Yummy Bait Tail Twister Mini	Bubble Gum	8
182-14-060/10	Yummy Bait Tail Twister Mini	Yellow	8
182-14-070/10	Yummy Bait Tail Twister Mini	Orange	8
182-14-080/10	Yummy Bait Tail Twister Mini	Green Chartreuse	8

CAMOLA

A true replica of an honey worm, one of the most appreciated trout baits. The camola is delivered per 8 pieces in a resealable plastic bag. The white colour is anise scented while the other colours are fish scented.



Two Camola Worms generate an intense rotation with strong vibrations.

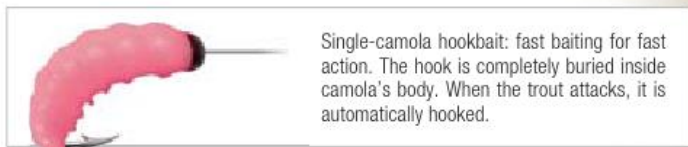

Single-camola hookbait: fast baiting for fast action. The hook is completely buried inside camola's body. When the trout attacks, it is automatically hooked.

Code	Description	Colour	Pcs
182-11-010/10	Yummy Bait Camola	White	8
182-11-020/10	Yummy Bait Camola	Natural	8
182-11-030/10	Yummy Bait Camola	Cream	8
182-11-050/10	Yummy Bait Camola	Bubble Gum	8
182-11-060/10	Yummy Bait Camola	Yellow	8
182-11-070/10	Yummy Bait Camola	Orange	8

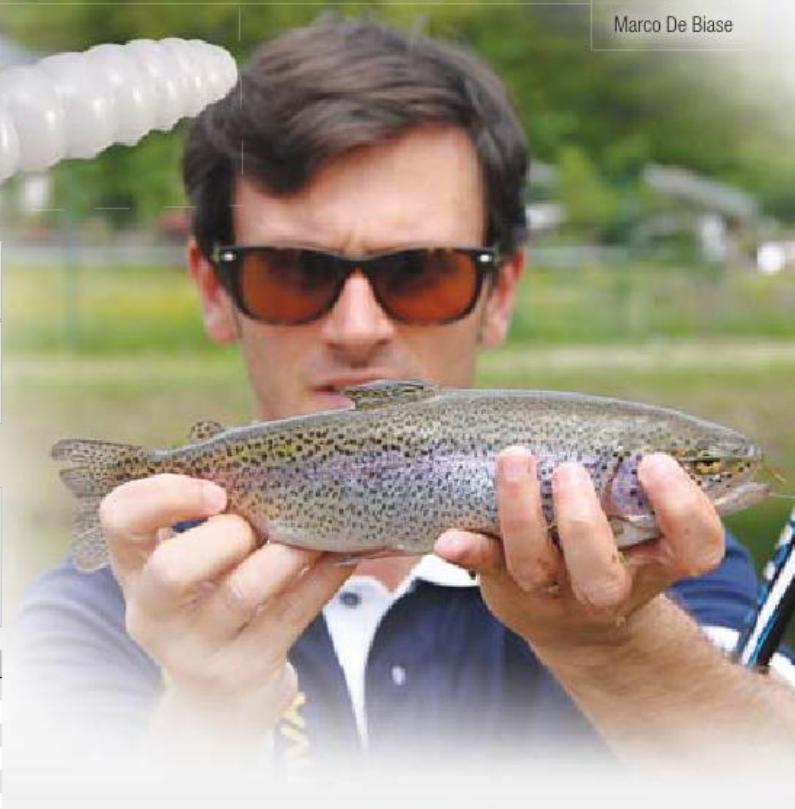

Marco De Biase

SOFTIE BIRD

Softie Birds is an incredible teaser for fishing up in the water, particularly for sailfish. Built in soft rubber, it offers a low resistance in the water while creating highly attractive splashes and bubbles. The different colours cover every combination water/weather. They're fitted with T-FORCE BIG GAME mono 120 Lbs length of 200 cm. The Softie Birds can be used alone in front of your favourite lure, or to create your own daisy chain.

Code	Size	Colour	mm / lbs	Length
189-79-620	15 cm	Black/Blue	1.20 / 120	200 cm
189-79-630	15 cm	Pink /White	1.20 / 120	200 cm



EXCITER BIRDS

The Exciter Birds are teaser with a classic shape but terribly effective, they will increase your catch rate. Once in the water, Exciter Bird causes splashes and bubbles on the surface that can attract predators from deep water up to the surface. The Exciter Birds can be used alone in front of your favourite lure, or in combination to increase the attractive power.

Code	Size	Colour
189-79-510	12.5 cm	Red / White
189-79-520	12.5 cm	Blue
189-79-530	12.5 cm	Pink



TROLLING DEEPER DIVER

Code	Description
101-25-210	Trolling Deeper Diver 87
101-25-220	Trolling Deeper Diver 107

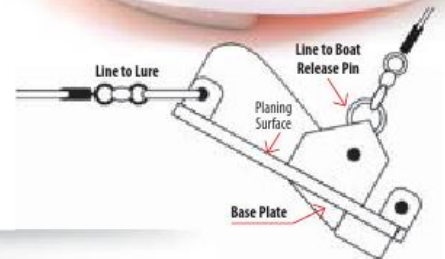
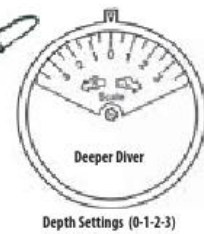

OCTOPUS SQUID

Octopus Squid are probably the most popular bait for sea fishing and we made them with the highest quality materials available now on the market. The Octopus have a tapered shape perfect for swimming, while all the colours have been accurately selected and all are holographic. They can be used alone, on the top of a dead fish or to make your favourite chain fitted with two or more octopus to attract big predators. They can be fished as well in conjunction with a teaser.

Code	Size	Weight	Colour	Pcs
189-00-501	19 cm	18 g	Halloween	2
189-00-601	22 cm	26 g	Halloween	2
189-00-402	16 cm	12 g	White/Red	3
189-00-502	19 cm	18 g	White/Red	2
189-00-303	14 cm	10 g	Purple	3
189-00-403	16 cm	12 g	Purple	3
189-00-503	19 cm	18 g	Purple	2
189-00-603	22 cm	26 g	Purple	2
189-00-604	22 cm	26 g	Orange/Yellow	2
189-00-305	14 cm	10 g	Wahoo	3
189-00-405	16 cm	12 g	Wahoo	3
189-00-505	19 cm	18 g	Wahoo	2
189-00-605	22 cm	26 g	Wahoo	2
189-00-306	14 cm	10 g	Silver/Orange	3
189-00-406	16 cm	12 g	Silver/Orange	3
189-00-506	19 cm	18 g	Silver/Orange	2
189-00-606	22 cm	26 g	Silver/Orange	2



TUNA TRASHER

Tuna Trasher has a dual coloured epoxy resin head with 3D flashing eyes. The skirt is made of reflective vinyl combined with bright coloured feathers to increase the attractive power.

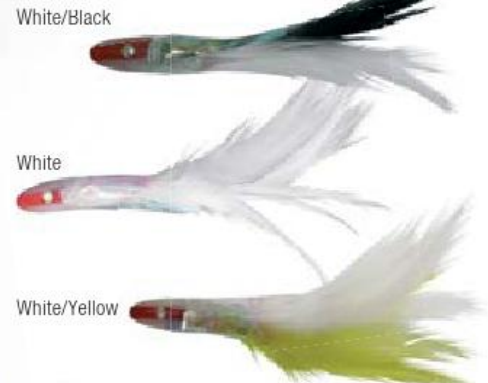

Code	Size	Weight	Colour	Pcs
189-81-710	13 cm	14 g	White	1
189-81-620	12 cm	12 g	White/Black	3
189-81-720	13 cm	14 g	White/Black	1
189-81-630	12 cm	12 g	White/Yellow	3
189-81-730	13 cm	14 g	White/Yellow	1

SOFT DORADO BUSTER

This soft lure has a very thick and heavy head, making it very resistant. The concave head displays several holes to create a jet effect during trolling action.



Code	Size	Weight	Colour
189-75-430	16 cm	35 g	Purple/Silver

TIGER SOFT SQUID

Tiger Soft Squid have a luminous heads and a siliconic skirt all comes rigged on 30cm of T-Force Big Game 1,00mm or 1,20mm depending on the lure's size. At the other end is positioned a 3way cross swivels, to allow you create advanced rigs made by two or more lures when deep fishing is a must.

Code	Size	Colour	Hook	ø Arm	Arm Length
189-33-131	13 cm	Fluo Blue	6/0	1.0 mm	30 cm
189-33-132	13 cm	Fluo Red	6/0	1.0 mm	30 cm
189-33-133	13 cm	Fluo Orange	6/0	1.0 mm	30 cm
189-33-134	13 cm	Fluo Nature	6/0	1.0 mm	30 cm
189-33-151	15 cm	Fluo Blue	6/0	1.0 mm	30 cm
189-33-152	15 cm	Fluo Red	6/0	1.0 mm	30 cm
189-33-153	15 cm	Fluo Orange	6/0	1.0 mm	30 cm
189-33-154	15 cm	Fluo Nature	6/0	1.0 mm	30 cm
189-33-181	15 cm	Fluo Blue	8/0	1.2 mm	30 cm
189-33-182	15 cm	Fluo Red	8/0	1.2 mm	30 cm
189-33-183	15 cm	Fluo Orange	8/0	1.2 mm	30 cm
189-33-184	15 cm	Fluo Nature	8/0	1.2 mm	30 cm

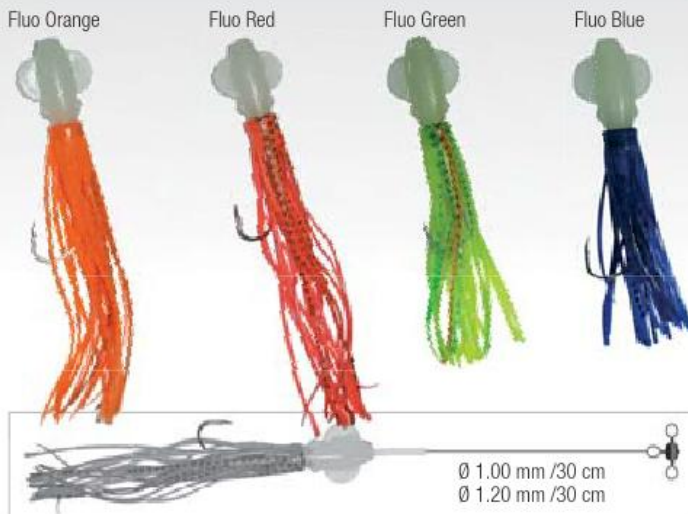

NATURAL BAIT

Natural Bait Needle



Natural Bait Cage

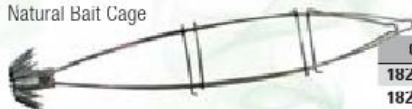

Code	Description
182-95-000	Natural Bait Needle
182-95-100	Natural Bait Cage

MADAI JIG SWIM

Brand new jig designed for saltwater vertical jigging, with the Japanese technique of Taikabura or Madai fishing. We suggest to fish Madai Swim in medium depth waters, preferably with sandy bottoms and jigged slower and near the bottom comparing to a classic vertical jig. It has Glow eyes for extra appeal in deep water plus durable skirt. Multiple hook system provides higher hook-up ratio. It's deadly attractive for all bottom feeders and predators, such as snappers, dentex and seabreams.

186-95-120



186-95-220



186-95-320



Code	Weight	Hook	Colour
186-95-120	20 g	BK	RBL
186-95-220	20 g	B	PYGO
186-95-320	20 g	G	FO

MADAI JIG ROUND

Fishing the Madai can be really profitable, especially when made in medium depth waters. Madai Jig Round features round shaped head design lets it sink quickly to the bottom and when jigged stabilize the jig parallel to the bottom maintaining a very natural appearance. Multiple hook system provides higher hookup ratio, while the Glow head Colors guarantees extra appeal in deep waters. Ideal for all predators and bottom feeders.

186-96-016



186-96-116



186-96-316



186-96-216



Code	Weight	Hook	Colour
186-96-016	16 g	OW	WGO
186-96-116	16 g	YO	WBO
186-96-216	16 g	BK	RBL
186-96-316	16 g	L	RBL
186-96-020	20 g	OW	WGO
186-96-120	20 g	YO	WBO
186-96-220	20 g	BK	RBL
186-96-320	20 g	L	RBL

SEA JIGGER

Jig designed to catch bottom feeders and predators in medium and deep waters. It has Glow head for extra appeal in deep, a large skirt and it's fitted a high quality Japanese treble hooks. This provides higher hook-up ratio. Sea Jigger must be worked on or just off the bottom, in particular in sandy bottom where the retrieve and the fall create a cloud that naturally attracts inquisitive fish.

Code	Size	Colour	Hook
186-90-000	80 g	Lumi/Blue	3/0
186-90-010	80 g	Lumi/Green	3/0
186-90-020	80 g	Lumi/Orange	3/0

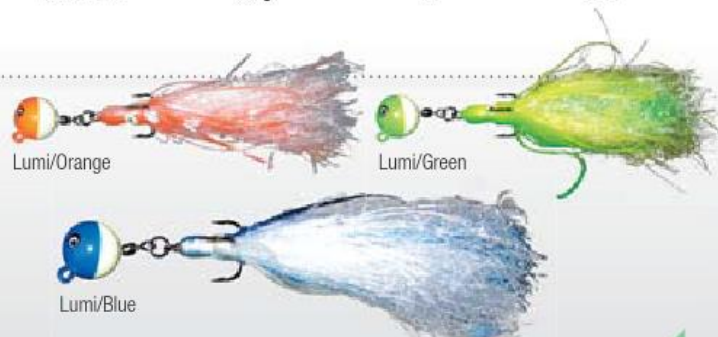

CLOTHING

Range of fishing clothing developed to perform at its best on the roughest conditions. The accurate selection of details and fabrics allows us to create garments with innovative design and technologically advanced. Designed with the very latest in material technology. The highest comfort level, breathability and thermal insulation as well as freedom of movement are guaranteed along the whole range.

GNT BREATHABLE SUIT

Gnt Breathable Suit provides the ultimate solution for anglers who want the maximum comfort in whatever the conditions. The suit offers a complete solution and it is not only a waterproof, thermal and breathable jacket and bib & brace, but also features a polar fleece that zips in and off perfectly the jacket.

Code	Description	Size
049-20-100	GNT Breathable Suit	M NEW
049-20-200	GNT Breathable Suit	L
049-20-300	GNT Breathable Suit	XL
049-20-400	GNT Breathable Suit	XXL
049-20-500	GNT Breathable Suit	XXXL NEW



POLAR FLEECE

Soft and comfortable non-pilling polar fleece with windproof lining, designed to keep you warm and dry during the coldest days. It's ideal to be worn in combination with the GNT Suit as it zips in and off perfectly on the jacket or as a top layer in its own right.

Fabric: 100% Polyester Fleece • Lining: antifriction 100% polyester • 2 front pockets • Elasticated cuffs • Waterproof collar and cuffs • Water & Wind Resistant



GNT JACKET

Designed with the very latest in material technology, GNT Jacket is completely waterproof, windproof and highly breathable. All seams are carefully double taped. The shoulders and other key area are reinforced by an additional layer to reduce wear. The adjustable hood offers full protection and a greater visibility and can be folded in the neck when not in use. The high fleece lining collar ensures extra warmth, whilst all the pockets features storm flap zip closure to prevent water in.

Fabric: octagonal fabric 100% polyester 320D • Lining: antifriction 100% polyester • Waterproof Rating: 5000mm • Breathable Rating: 3000mm • Taped seams • Adjustable peaked hood • Zippered pockets with storm flaps • Separate mobile phone pocket



GNT BIB & BRACE

Totally waterproof and with and highly breathable the Gnt Bib & Brace is designed to offer the maximum protection in the roughest conditions and it's packed full of features to make your fishing more comfortable. The antifriction lining is designed for ease of movement, while all seams are carefully double taped. The knee, seat and all other key areas have been reinforced by an additional layer to reduce wear. The elasticated straps can be adjusted to fit your height, or totally removed to be worn as regular trousers. The wide opening leg bottom is provided with strong zip and an adjustable storm flap closure.

Fabric: octagonal fabric 100% polyester 320D • Lining: antifriction 100% polyester • Waterproof Rating: 5000mm • Breathable Rating: 3000mm • Taped seams • Adjustable waist strap • Wide opening leg bottom • Reinforced key areas

TRABUCCO CAP

Young and sporty, the new Trabucco cap is made from cotton and has eyelets on top to keep fresh inside. One size fits all

Code
040-13-018



GNT WINTER CAP

The Gnt Winter cap is made from soft and warm non-pilling polar fleece. Featuring ears protecting flap.

Code
040-13-017



GNT CAP

The GNT Cap is made from 100% hard wear ing cotton. A metal clasp allows easy adjustment and one size fits all.

Code
040-13-015



GNT POLAR FLEECE

The Gnt Polar Fleece features a soft non-pilling polar fleece reinforced on the shoulders and other key area by an additional windproof and water-resistant Taslon layer. Whilst the lining guarantees an high breathability rating and ease of movement. Gnt fleece is ideal to wear under waterproofs for extra warmth or as a top layer in its own right. The outer pockets are zipped to give security for phones and car keys.

- Fabric: 100% Polyester Fleece
- Water & Wind Resistant
- Taslon reinforced
- Zippered Pockets
- Elasticated cuffs

Code	Size
049-24-000	S NEW
049-24-100	M
049-24-200	L
049-24-300	XL
049-24-400	XXL
049-24-500	XXXL NEW



GNT SOFT SHELL JACKET

The Gnt Jacket is a three layered soft shell jacket. The outer fabric is windproof and water resistant, the middle layer offers an high breathability, whilst the inner polar fleece guarantees the maximum comfort and thermal insulation keeping you warm and dry. Soft shell is extremely hard wearing and fantastically flexible fitting to your body without constricting.

- Fabric: 100% 3 layers Soft-Shell
- Water & Wind Resistant
- Breathable
- Adjustable cuffs
- Removable & Adjustable hood

Code	Size
049-22-200	L
049-22-300	XL
049-22-400	XXL

MICROPILE GNT



Lightweight and very soft, the GNT micro fleece is ideal to wearing in midseason or under a thermal suit for added protection. The elasticized cuffs, the high open collar, the embroidered logo make it complete.

Code	Description	Size
049-25-200	GNT Micropile	L
049-25-300	GNT Micropile	XL
049-25-400	GNT Micropile	XXL



FELPA GNT

Very soft and comfortable sweatshirt made from cotton and polyester mixture. Round neck, elasticized cuffs and bottom, with stylish embroidered logo.

Code	Description	Size
049-26-200	GNT Fleece	L
049-26-300	GNT Fleece	XL
049-26-400	GNT Fleece	XXL

GNT DRY-TEK CAP

Soft, lightweight and breathable baseball cap entirely made from Dry-Tek fabric. The Dry-Tek material is designed to keep you cool, dry and comfortable in warm weather. Featuring overlapping Velcro closure, pre-curved bill with contrast color and sewn eyelets.



Code
040-13-016

POLO GNT DRY-TEK

The Gnt Dry-Tek Polo are designed to keep you cool and dry in warm weather, by wicking sweat away from the body. The Dry-Tek fabric is also breathable, lightweight, easy to care and super soft to offer the maximum comfort.

Code	Description	Size
042-10-100	GNT Dry-Tek Polo	M
042-10-200	GNT Dry-Tek Polo	L
042-10-300	GNT Dry-Tek Polo	XL
042-10-400	GNT Dry-Tek Polo	XXL



POLO GNT

Polo shirt made by cotton with a stylish embroidered logo, extremely comfortable also in the hottest days.

Code	Description	Size
042-12-100	GNT Polo Shirt	M
042-12-200	GNT Polo Shirt	L
042-12-300	GNT Polo Shirt	XL
042-12-400	GNT Polo Shirt	XXL



PLATINUM RAIN SUIT

Platinum Rain Suit offers a comfortable jacket and trousers, both made of 320D Nylon with mesh lining and PU coating, for maximum water resistance. It features elasticized cuffs, with velcro straps, and adjustable belt and hood. Platinum Rain Suit is best choice for the warm season.



Code	Description	Size
049-92-200	Platinum Rain Suit	L
049-92-300	Platinum Rain Suit	XL
049-92-400	Platinum Rain Suit	XXL



NEW EXXON FLEECE

Polar fleece with elasticated waist and cuffs. Provided of a long zipper and large pockets. Blue Navy and Blue Royal color.

Code	Size
049-60-400	XXL

MICRO T1 RAIN SUIT



NEW T-SHIRT TRABUCCO GNT



Code	Size
040-86-100	M
040-86-200	L
040-86-300	XL
040-86-400	XXL

T-SHIRT TRABUCCO WHITE



Code	Size
040-85-320	L
040-85-330	XL
040-85-340	XXL

This suit in microfibre completely lined with soft polar fleece, comprising jacket and trousers, is warm weather-resistant and breathable, it is suitable for use in all kinds of weather. Equipped with rainhood and high quality reinforced zip. The trousers are padded till the knees, thus to avoid the water to enter.

Code	Description	Size
049-95-300	Micro T1 Complete Suit	XL
049-95-400	Micro T1 Complete Suit	XXL
049-96-300	Micro T1 Jacket	XL
049-96-400	Micro T1 Jacket	XXL
049-97-300	Micro T1 Trousers	XL
049-97-400	Micro T1 Trousers	XXL



WWW.TRABUCCO.IT

Enter the Trabucco's world through its website. Sign the Newsletter to follow our Champions and see their videos, where you can find advise and get some trick that will help you to catch more fish. Check our on line catalogue to discover the huge Trabucco assortment and find out the shop closer to you. Sign in our social network profiles to share experiences, pictures, videos and link. We are all waiting for you!

- ON-LINE CATALOG
- NEWSLETTER
- WHERE TO BUY
- FISHING VIDEO
- PHOTO GALLERY
- BE SOCIAL



<http://www.youtube.com/trabuccofishing>

<http://www.facebook.com/TrabuccoFishing>



<http://www.youtube.com/KKarpfishing>

<http://www.facebook.com/KKarpInspirethenext>



WWW.K-KARP.COM

K-Karp is passion, and as per all the passions you will enjoy it more through sharing. The K-Karp website is at your disposal to show you the countless new products coming out monthly and to know in advance the places where our testimonials will meet the anglers. You can also find a video section where you can see and "feel" the way our experts are living the K-Karp experience. If you don't want to miss any news or just you want to share pictures, videos or just opinions, you can sign in our social network profiles, while all the other colours are fish scented.

<http://www.youtube.com/Rapturelures>

<http://www.facebook.com/Rapturelures>



WWW.RAPTURELURES.COM

Rapture is a brand gathering a huge number of hard and soft lures, both for fresh and salt water, and a great assortment of rods, always more calibrated on specific predator fishing techniques. We are always very attentive to the new fishing styles and trends and we like to receive inputs and share opinions on social networks. Sign in our Newsletter to get the latest news and write us what you think. On Rapture social network pages you can share your videos and pictures too.

<http://www.facebook.com/Catfishinggear>



WWW.CATGEARFISHING.COM

The biggest fish of our rivers is able to give us unique emotions, thanks to its size, its power and also thanks to the water speed. That's why it gets the attention of all of us also on the web, which offers the visitors of Catgear site the chance to read the online catalogue, updating their own knowledge about most advanced tackle. Facebook page represents an incredible opportunity to exchange opinions and experiences with anglers from all over Europe.

PRO SWORD HOOKS
 ADVANCED TECHNOLOGY
 TRABUCCO FISHING
 REELS
 CANNE FISSE
 FISHING
 BEACH LEGERING
 BOLOGNESI
 SIRODS
 TRABUCCO FISHING TACKLE CATALOG
 TROTA LAGO
 MATCH ROD
 FEEDER
 BEACH LEGERING
 TRABUCCO FISHING TACKLE CATALOG
 SURFCASTING GRODS
 BIG GAME
 CARP FISHING
 ROUBAISIENNE
 POLE ELASTICATION S-FORCE
 SABIKILAKE TROUT
 TRABUCCO PRODUCT GUIDE
 BIG PIT
 FRESH WATER
 PRO SWORD HOOKS
 ADVANCED TECHNOLOGY
 TRABUCCO
 REELS
 CANNE FISSE
 REELS
 LAKETROUT
 TELESCOPIC WHIPS
 TROTA LAGO
 MATCH ROD
 FEEDER
 BEACH LEDGERING
 TRABUCCO FISHING TACKLE CATALOG
 SURFCASTING GRODS
 PRO SWORD
 MULINELLI
 CARP FISHING
 XPS
 BOAT RODS
 ROUBAISIENNE
 POLE ELASTICATION S-FORCE
 SABIKILAKE TROUT
 RIVER FEEDER
 FRESH WATER
 BIG PIT
 MERGHIA



TRABUCCO
FORM & PERFORMANCE

WWW.TRABUCCO.IT

Trabucco Fishing Diffusion S.r.l
 Via Atene, 7 - Zona CEPIM Interporto
 43010 Bianconese di Fontevivo (PR) Italy
 Tel.: +39 0521 618000 r.a.
 Fax: +39 0521 617032
 E-mail: info@trabucco.it



<http://www.facebook.com/TrabuccoFishing>
 Like us on facebook. Our page is the ideal place where you can share your pictures.



<http://www.youtube.com/trabuccofishing>
 Subscribe our Youtube channel and see our latest movies and follow the exploits of our champions.



<https://twitter.com/trabuccofishing>
 Share your passion and become our follower on Twitter.